

Installation Instructions for SS1 Soft Strip, 1.4 Watts 24V

IMPORTANT INFORMATION

- This product is ETL listed for indoor locations.

SAVE THESE INSTRUCTIONS!

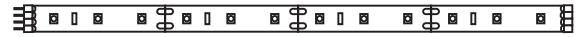

Install the Soft Strip

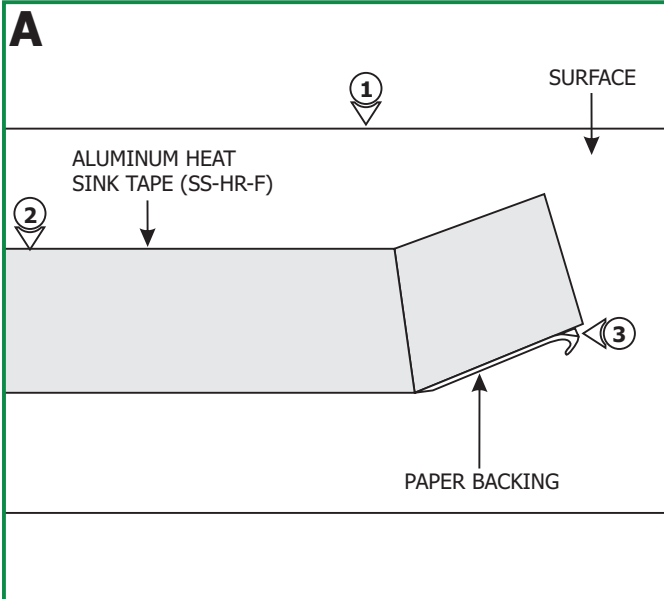

NOTE: The soft strip LEDs are rated for 32,000 hours when using the aluminum heat sink tape (SS-HR-F).

NOTE: The adhesive tape of the aluminum heat sink needs to be affixed on smooth clean surfaces (2" minimum). The adhesiveness of the tape does not work well with porous, textured, or unfinished wood surfaces, soft strip clips are required (sold separately).

- 1: Clean the area thoroughly where soft strip LED will be installed. **(do not install it in an enclosed area)**
- 2: For all surfaces other than aluminum, use the provided aluminum heat sink tape (SS-HR-F) to avoid overheating which may cause LEDs to fail.
- 3: Remove the backing from the aluminum heat sink tape (SS-HR-F) and firmly press it down where the LED soft strip is going to be mounted.

- 4: Align the LED soft strip power wires so that the solid red wire (side of connector with dot) of the power feed pin connects to 24VDC soft strip pin. The red/black wire will automatically be connected to the other pins.

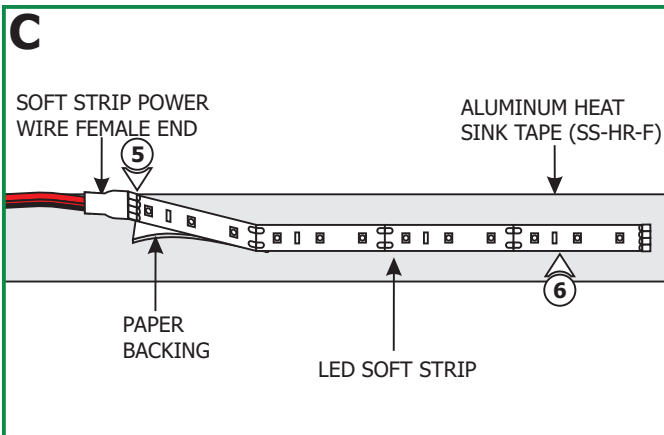
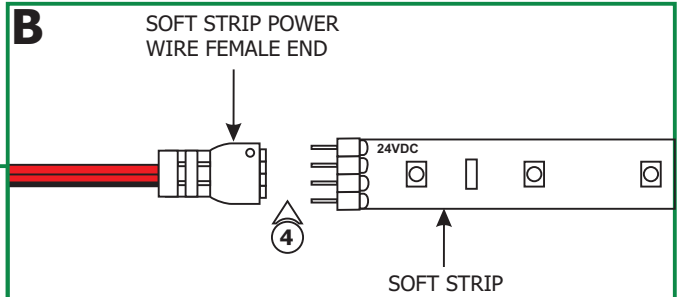

NOTE: Avoid bending the soft strip in sharp vertical angles which may damage the LEDs. Soft Strips do not bend horizontal. Use proper directional connectors for horizontal turns.

- 5: Push the soft strip power wire female end onto the soft strip male end connector.
- 6: Carefully remove the backing from the LED soft strip, make sure not to remove the tape from the soft strip. Firmly press down the adhesive portion of the soft strip onto the aluminum surface while removing the rest of the backing, making sure there are no air bubbles that can cause surface irregularities.

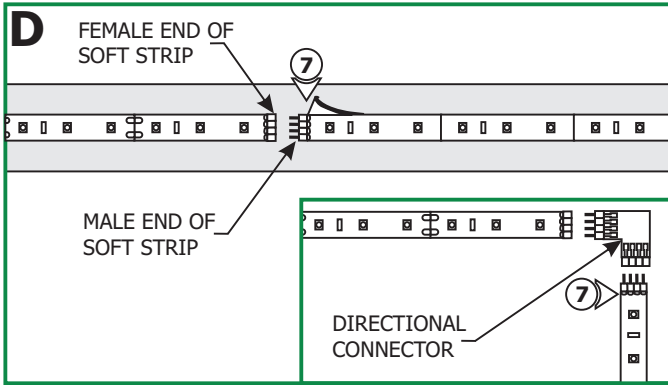

7: Add the other piece of soft strip by simply connecting female end of the soft strip to the male end of the new soft strip directly or with interfacing of the directional connectors.

8: The 4" long soft strips can be used for fine adjustments.

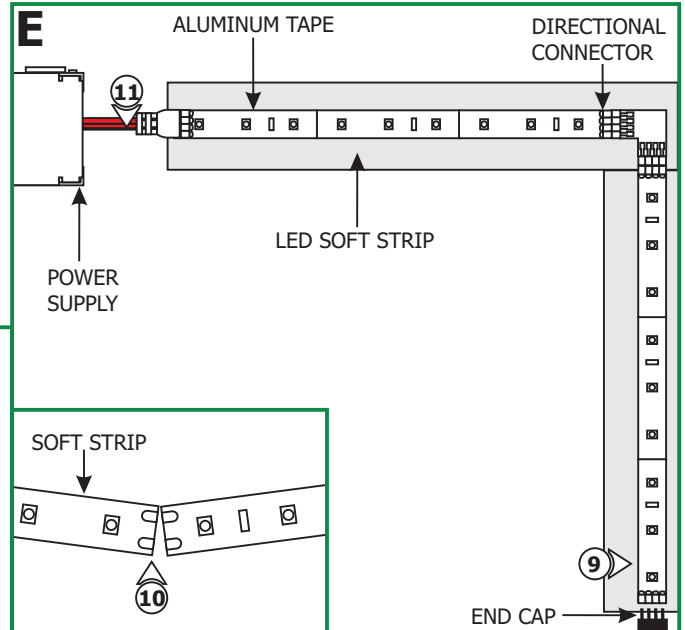

9: Use the optional end cap to cover the end of the soft strip.

10: The excess amount of soft strip can be cut by the indicated sections of the run with a pair of scissors. Once the soft strip is cut, it cannot be extended.

11: Install the power supply by referring to the instructions provided with the power supply.

NOTE: SS1 soft strip consumes on average 1.4 Watt per foot.

Relocating Soft Strip (Optional)

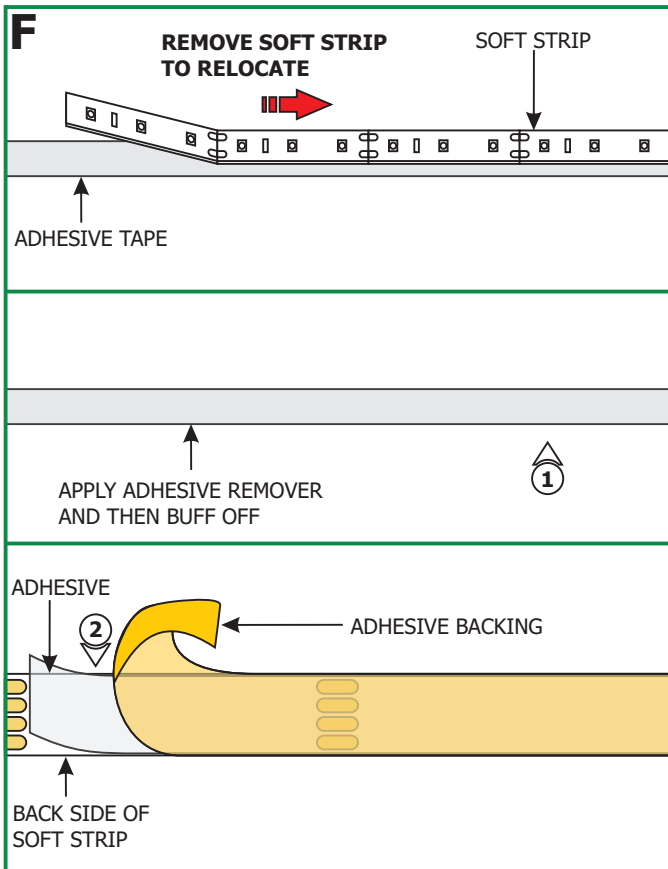

NOTE: If relocating the installed soft strip, make sure that the adhesive tape on back of the soft strip covers the entire strip. The adhesive tape on back of the soft strip isolates the strip from the conductive heat sinks. Damaged or inconsistent adhesive tape may cause the contacts on the back of the strip to come in contact with the conductive heat sink which will cause the strip to short and burn. Call Edge Lighting to get replacement adhesive tape and aluminum heat sink tape (SS-HR-F)

1: To remove the tape residue from back of the strip apply moderate amount WD-40, or Goo Gone, or a mixture of warm water and lemon oil to the corner of a clean, dry towel. Gently buff the area containing the adhesive residue with small circular motion until it is completely removed.

2: From one side of the tape gently remove a few inches of the backing. Attach the adhesive tape to the back of the soft strip and apply moderate pressure to affix the tape. Continue this step a few inches at the time until the entire adhesive tape is attached to back of the soft strip.

3: Refer to the steps on 1 through 11 to reinstall the soft strip.

Overall Wiring Diagram

