

### Description:

Cirrus Channel Wall Grazer features a lens that provides dramatic accent lighting to highlight textured surfaces. At 7 or 10.5 watts per foot, the 24 volt DC channel contains 85+ or 95+CRI LEDs. Includes a split canopy that mounts on standard junction box. May be ordered with a Slim Profile Channel Junction Box (C-1RE-JBOX). Mounting clips are provided every 18 inches. Cirrus is powered by a Class 2 remote power supply up to 40 feet away. Available from 12 inches to 120 inches/10 feet (10DC) or to 144 inches/12 feet (7WDC). May be ordered in 3, 5, 8 or 10 inch increments. Lengths greater than 120 inches will ship as two or more segments that join together. Fixtures include a 5 year warranty.

### Finishes:

Satin Nickel, Chrome, Antique Bronze, Satin Aluminum, White and Satin Black; Custom finishes available

### Applications:

Wall grazing for textured surfaces such as architectural wall panels, hallways, brick, stone or wood treatments, wet location IP53

### Lamp:

Version	Watts per Foot	Lumens		85+CRI 24K, 35K, 40K, 57K	95+CRI 27K, 30K	50,000 Hour Lamp Life
		per Watt	per Foot			
<b>7WDC 27K</b>	7	63	442	●	●	●
<b>7WDC 30K</b>	7	66	463	●	●	●
<b>10DC 27K</b>	10.5	60	628	●	●	●
<b>10DC 30K</b>	10.5	64	667	●	●	●

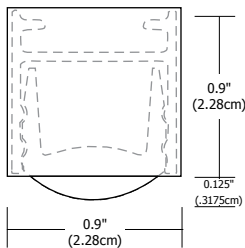
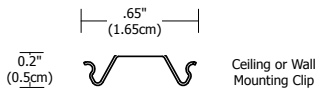

### Power Supply (24VDC):

- PSB-25W-010-24VDC** 120VAC input, 25 watt output
- TEB-60L-24DC** 120VAC input, 60 watt output
- PSB-60W-ELV-24VDC** 120VAC input, 60 watt output
- PSB-96W-010-24VDC** 120-277VAC input, 96 watt output
- PSB-100W-ELV-24VDC** 120VAC input, 96 watt output
- PSB-2X96W-010-24VDC** 120-277VAC input, 2x96 watt output
- PSB-2X100W-ELV-24VDC** 120VAC input, 2x96 watt output

### Slim-Profile Junction Box (sold separately):

The Slim-Profile Junction Box with hanger bars mounts to studs spaced between 14.5"- 25" apart behind drywall. Allows low voltage DC wires from remote power supply to connect to channel wires. Junction box opening is covered by the fixture for a clean, safe connection. Includes a goof plate, for poor plastering around j-box, which may be plastered and painted.

### Dimming:

010 power supplies use 0-10V dimmer: Philips Sunrise SR1200ZTUNV. ELV power supplies use ELV dimmer: Legrand, Adorne ADTP703TU; Lutron: Diva DVELV-300P, Skylark SELV-300P, Maestro MAELV-600 and Radio Ra 2

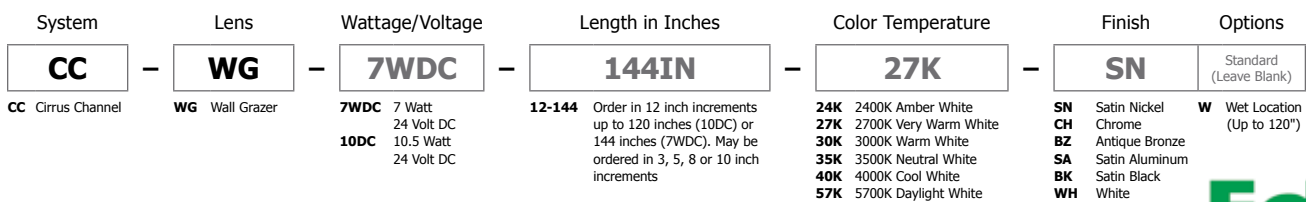
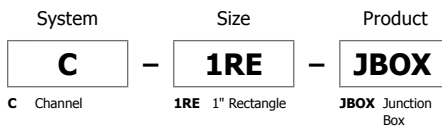

# CIRRUS CHANNEL WALL GRAZER 24VDC SYSTEM, 85+ OR 95+CRI

REV01.14.15

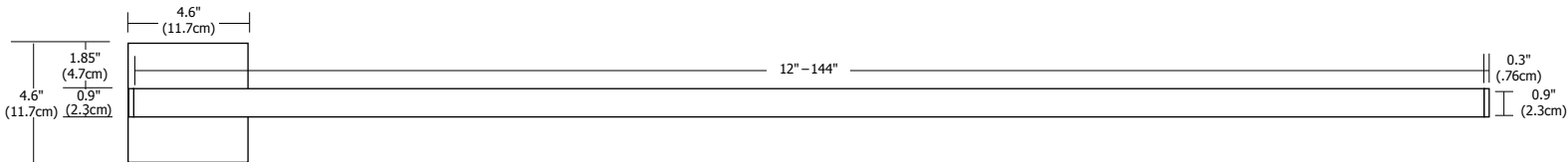

Split Canopy (included)  
with Cirrus Channel.  
May be mounted at End.

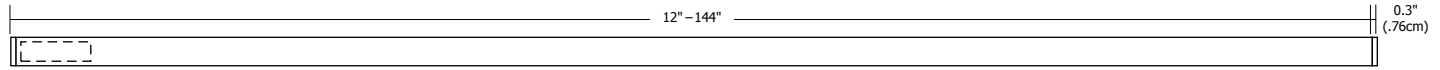

Shown with C-1RE-JBOX (sold separately)



Satin Aluminum Anodized



Satin Nickel Anodized



Antique Bronze Anodized



Satin Black Anodized



Chrome Plated



White Powder Coated

**Application:** 0-10V dimming for Cirrus Channel Wall Grazer

**Power Supply:** Class 2, 24VDC output: 120VAC input, PSB-25W-010-24VDC;  
120-277VAC input, PSB-96W-010-24VDC; PSB-2X96W-010-24VDC

**Dimming:** Dimmable with 0-10V dimmer: Philips Sunrise SR1200ZTUNV, 0-10V dimmer recommended

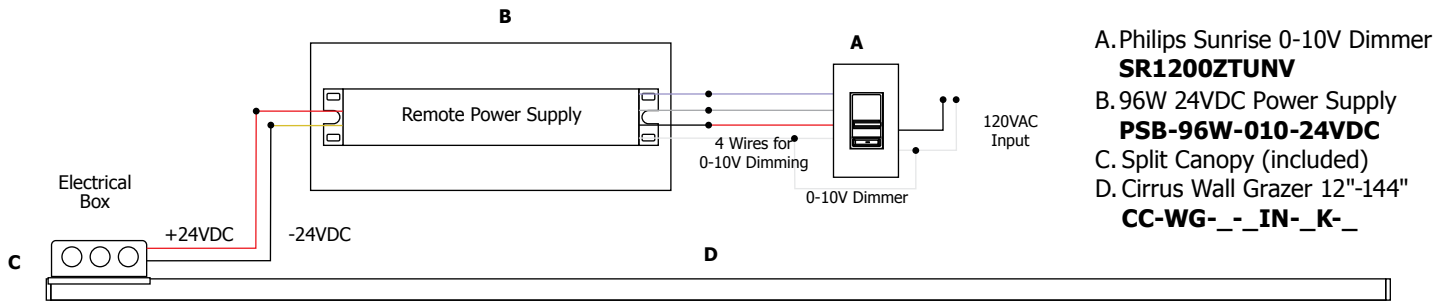

Warm White (4ft) with 10° Clear Grazing Lens	
Distance	Foot Candles
12in	742
24in	319
36in	179
48in	114

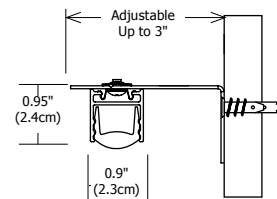
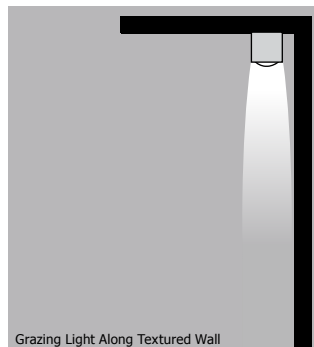

Side View of MCL-090

PROJECT:

FIXTURE TYPE:

DATE:

# SLIM-PROFILE JUNCTION BOX

REV09.04.14

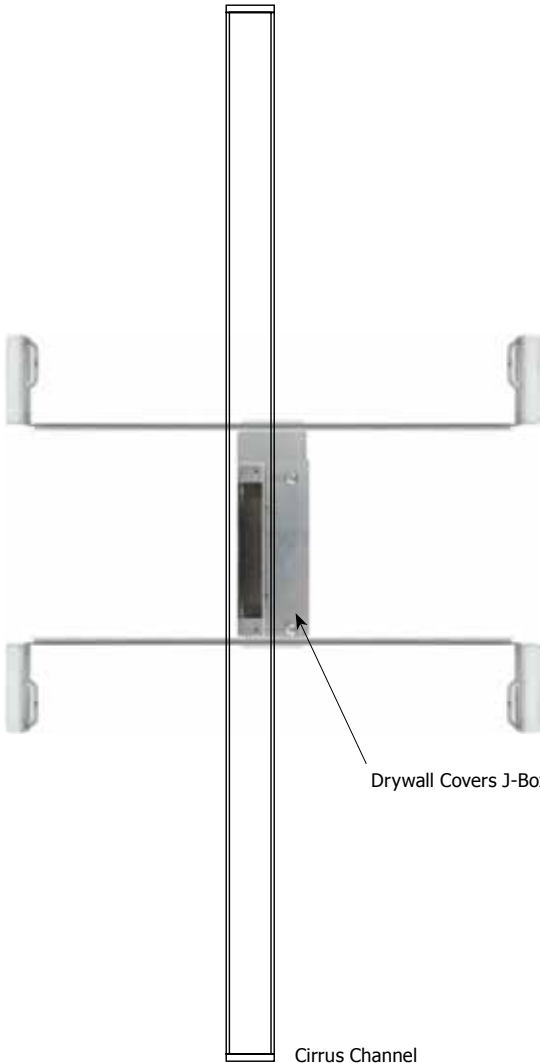
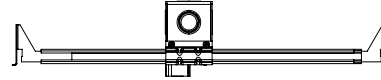
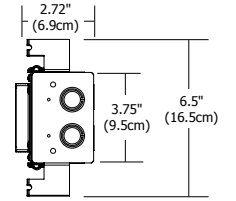
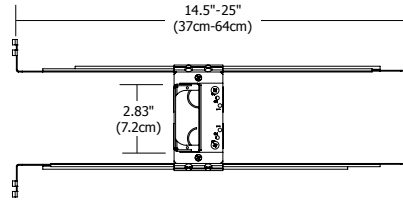

## Description:

The Slim-Profile Junction Box with hanger bars mounts to studs spaced between 14.5"- 25" apart behind drywall. Allows low voltage DC wires from remote power supply to connect to channel wires. The junction box opening is covered by the fixture for a clean, safe connection. Includes a goof plate, for poor plastering around j-box, which may be plastered and painted.

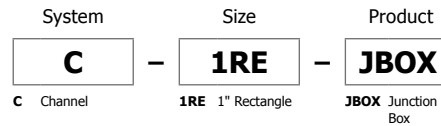

PROJECT:

FIXTURE  
TYPE:

DATE:

# CHANNEL L-SHIELD FOR CIRRUS WALL WASH AND WALL GRAZER

REV01.14.15



## Description:

The Channel L-Shield mounts to the ceiling along the Cirrus Wall Wash or Cirrus Wall Grazer fixtures (with C-1RE-JBOX only) to shield light brightness from view.

System	Product	Length	Finish
<b>C</b>	<b>L2.5</b>	<b>8FT</b>	<b>WH</b>
C Channel	L2.5 L- Shield 2.5" Height	8FT 8 Feet	WH White

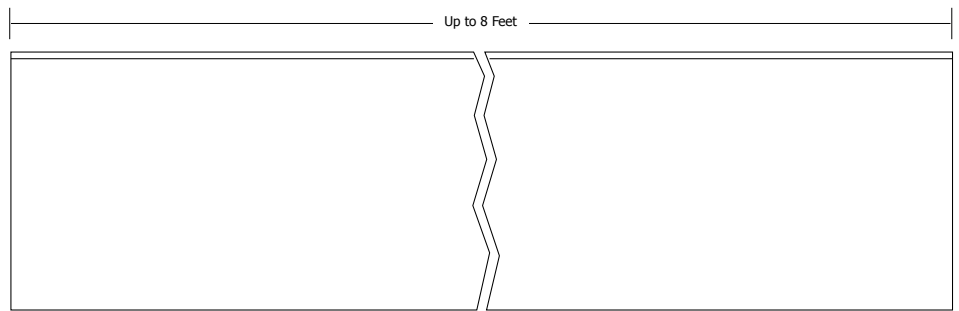
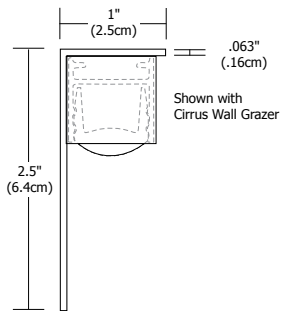

PROJECT:

FIXTURE  
TYPE:

DATE:

Please refer to chart below for exact lengths of the Cirrus Channel Wall Grazer

CODE	LENGTH (INCHES)	CODE	LENGTH (INCHES)
12IN	12.55	80IN	79.75
15IN	14.95	82IN	82.15
17IN	17.35	84IN	84.55
20IN	19.75	87IN	86.95
22IN	22.15	89IN	89.35
24IN	24.55	92IN	91.75
27IN	26.95	94IN	94.15
29IN	29.35	96IN	96.55
32IN	31.75	99IN	98.95
34IN	34.15	101IN	101.35
36IN	36.55	104IN	103.75
39IN	38.95	106IN	106.15
41IN	41.35	108IN	108.55
44IN	43.75	111IN	110.95
46IN	46.15	113IN	113.35
48IN	48.55	116IN	115.75
51IN	50.95	118IN	118.15
53IN	53.35	120IN	120.55
56IN	55.75	123IN	123.25
58IN	58.15	125IN	125.65
60IN	60.55	128IN	128.05
63IN	62.95	130IN	130.45
65IN	65.35	132IN	132.85
68IN	67.75	135IN	135.25
70IN	70.15	137IN	137.65
72IN	72.55	140IN	140.05
75IN	74.95	142IN	142.45
77IN	77.35	144IN	144.85

PROJECT:

FIXTURE  
TYPE:

DATE: