

Specifications/Features

Housing/Mounting

Low silhouette design for remodeling applications in solid or suspended ceilings.

In-line style transformer placement with adjustable support foot.

Narrow fixture design for fast installation through ceiling opening minimizes remodeling mess.

Retractable mounting clips allow easy installation into existing ceiling.

Fixture is easily installed through ceiling opening.

Retractable mounting clips lock fixture in place and adjust for different ceiling thicknesses from 1/2" to 1-1/4".



Lamp/Electrical

(1) 50W 12V MR16, GU5.3 base.

Prewired with 120/12V thermally protected Class H magnetic transformer conveniently mounted to end of J-Box.

J-Box has (6) 1/2" knock outs with spring latch access plates.

Removable porcelain socket is wired with Molex connector to J-Box.

Optional Electronic Transformer:

Input: 120V 60Hz; Output at max. load: 11.7V 40kHz

Short circuit and thermally protected.

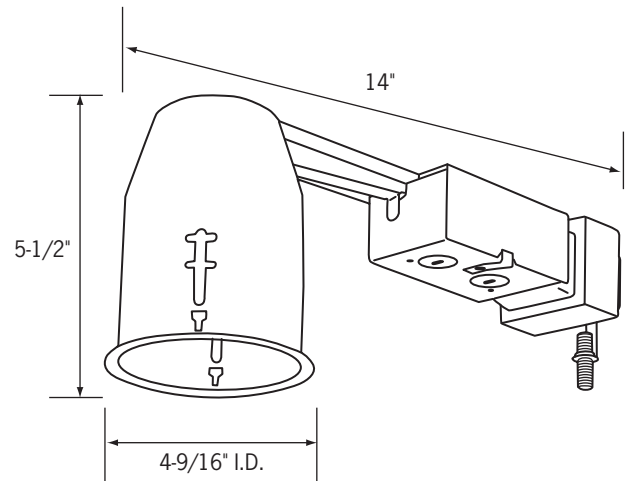

Ceiling Opening: 4-1/8"
Max. Ceiling Thickness: 1-1/4"

Trims

Wide selection of trim models available to suit a broad range of applications. See "Trims for 4" Low Voltage Recessed Housings" specification sheet for details.

On trims designed for use with MR16 lamps, Con-Tech Lighting provides a clear, tempered safety glass. This safety glass should only be used with open MR16 lamps, and not used with MR16 lamps that contain an integral glass lens.

Warranty

This fixture is covered by ConTech's full one (1) year replacement guarantee after date of purchase.

Transformer has a one (1) year warranty.

Labels/Usage

cCSAus Certified. Suitable for damp locations.

Ordering Information

Example Order:

Housing/Voltage

LVR16-TR - 120V/12V
LVR16-TRE - 120V/12V
Electronic Transformer

Trims

For Trims, see "Trims for 4" Low Voltage Recessed Housings" specification sheet.

Specifications/Features

- Maximum lamp rating for most trim options: 50W 12V MR-16 lamp, GU5.3 base, unless noted.
- On recessed trims designed for use with MR16 lamps, ConTech Lighting provides a clear, tempered safety glass. This safety glass should only be used with open MR16 lamps, and not used with MR16 lamps that contain an integral glass lens. If use of MR16 with front glass is required, remove the factory provided clear tempered safety lens.
- All trims have white trim finish unless specified.
- All trims are cCSAus Certified and suitable for damp locations; only shower trims are listed for wet locations.

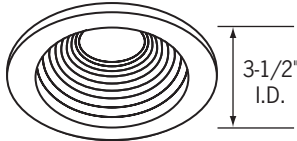

Baffled Downlight

Standard Trim, 5-1/2" O.D.

CTR1601-B

Adjustable Black Baffle, Black Trim Ring

CTR1601-P

Adjustable Black Baffle

CTR1601-P-WHT

Adjustable White Baffle

Narrow Trim, 4-15/16" O.D.

CTR1601N-P

Adjustable Black Baffle

CTR1601N-P-WHT

Adjustable White Baffle

Cast Aluminum Trim, 5-1/8" O.D.

CTR1601-PA-WHT

Adjustable White Baffle

CTR1601-BA

Black Baffle, Black Cast Aluminum Trim Ring

Deep baffle traps stray light and conceals lamp. May be used as downlight or adjustable accent light with 60° swing adjustment. Trim uses stepped lens holder design and can hold up to two (2) light controlling elements. 45mm lens on lower level of lamp seat, 50mm lens on higher level.

75W lamp may be used with LVR1675 housings.

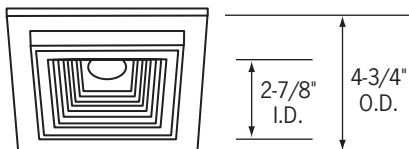

CTR1604-P

Black Baffled Square

Deep baffle traps stray light and conceals light source. Downlight or adjustable: up to 35° vertical adjustment. 45mm lens.

75W lamp may be used with LVR1675 housings.

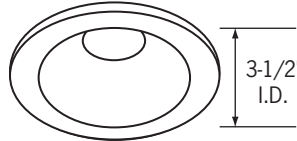

Adjustable Multiplier

Standard Trim, 5-1/2" O.D.

CTR1602-P-(BLK, CLR, PL, WHT)

White Trim Ring, Select Reflector Finish

CTR1602-B-BLK

Black Trim Ring, Black Reflector

CTR1602-(ST, NK)-CLR

Select Metal Trim Finish, Clear Reflector

Narrow Trim, 4-15/16" O.D.

CTR1602N-P-(CLR, WHT)

White Trim Ring, Select Reflector Finish

CTR1602N-B-BLK

Black Trim Ring, Black Reflector

Cast Aluminum Trim, 5-1/8" O.D.

CTR1602-PA-(CLR, WHT)

Multipliers utilizes a highly polished, specular reflector to maximize light intensity while concealing the light source. Offers the flexibility to be used as a downlight or adjustable accent light with 35° swing adjustment. Trim uses stepped lens holder design and can hold up to two (2) light controlling elements. 45mm lens on lower level of lamp seat, 50mm lens on higher level.

75W lamp may be used with LVR1675 housings.

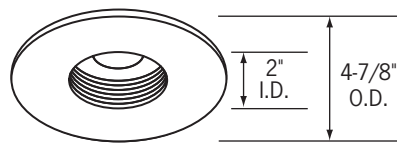

CTR1605-P*

Black Baffled Pin Spot

CTR1605-P-WHT*

White Baffled Pin Spot

Precise beam spread and unobtrusive appearance. Concealed lamp design for maximum eye comfort. Deep baffle. Baffle extends 1/16" past trim face. Trim uses stepped lens holder design and can hold up to two (2) light controlling elements. 45mm lens on lower level of lamp seat, 50mm lens on higher level.

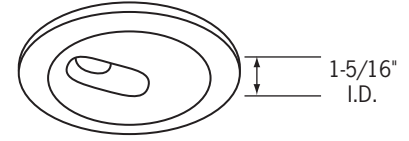

Slotted Wall Wash

Standard Trim, 5-1/2" O.D.

CTR1603-P

Narrow Trim, 4-15/16" O.D.

CTR1603N-P

Slot aperture permits maximum beam area adjustment for either wall wash or concealed accent lighting effects. 50° swing adjustment, 358° rotation. 50mm lens.

75W lamp may be used with LVR1675 housings.

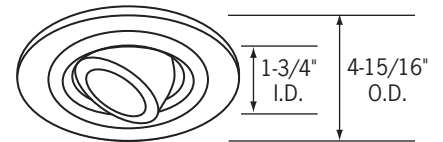

CTR1606-(B, P)*

Surface Adjustable

45° Max. vertical and 359° rotational aiming. Die-cast aluminum construction. Front access for re-lamping. 50mm lens. Not compatible with LVR-16 Housing.

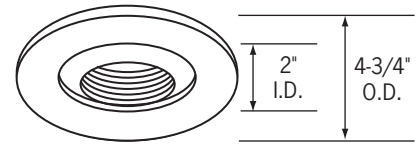

CTR1607-P

Adjustable Pin Spot, Black Baffle

CTR1607-P-WHT

Adjustable Pin Spot, White Baffle

Low profile gimbal design for aiming flexibility. 35° swing adjustment. Trim uses stepped lens holder design and can hold up to two (2) light controlling elements. 45mm lens on lower level of lamp seat, 50mm lens on higher level.

75W lamp may be used with LVR1675 housings.

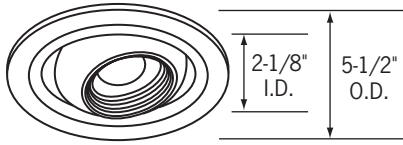

CTR1608-P

Black Baffled Eyeball

Up to 45° vertical aiming, 358° rotational adjustment. Black baffle provides excellent cutoff and lamp concealment. 45mm lens.

75W lamp may be used with LVR1675 housings.

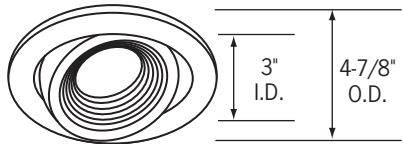

CTR1609-P*

Surface Adjustable, Cast Black Baffle

CTR1609-P-WHT*

Surface Adjustable, Cast White Baffle

Low glare baffle. Downlight or adjustable accent light with up to 35° vertical and 358° rotational adjustment. 50mm lens.

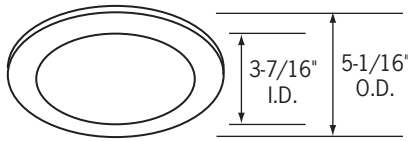

CTR1611FR-(NK, P, ST)*

Flat Frosted Glass Shower Light

CTR1611CL-(NK, P, ST)*

Flat Clear Glass Shower Light

Die cast aluminum. Double neoprene gasketed. Clear specular reflector. cULus listed for wet locations.

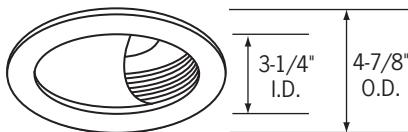

CTR1613-P*

Black Baffled Scoop Wall Wash

CTR1613-P-WHT*

White Baffled Scoop Wall Wash

For even wall wash light distribution. 45mm Lens.

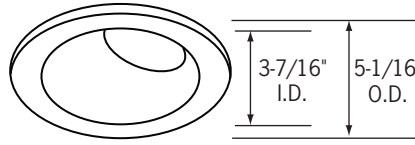

CTR1614-P-CLR*

Clear Reflector Angled Wall Wash

Adjustable lampholder; 55-75° aiming angle. 45mm lens.

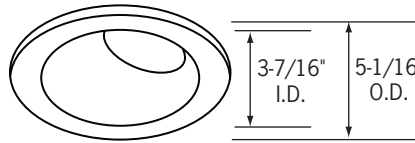

CTR1614CL-P-CLR*

Angled Wall Wash Shower Trim

Die cast aluminum. Clear specular angled reflector. Adjustable lampholder; 55-75° aiming angle. Double neoprene gasketed. Clear glass lens. 45mm lens.

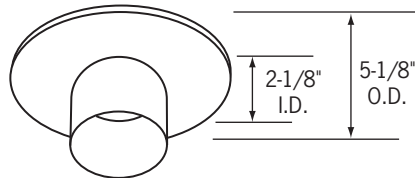

CTR1621F-(NK, P)*

Frosted Glass Cylinder

Cylindrical glass diffuser with specular reflector focuses light downward and eliminates glare. Depth From Ceiling: 2"



CTR1624-(B, NK, P, ST)*1

Fully Adjustable Square in Round, Select Finish

87° vertical and 359° rotation adjustment. Die-cast aluminum construction. Front access, spring latch lamp retainer ring (black finish). 47mm lens. Depth from ceiling: 2-1/2"

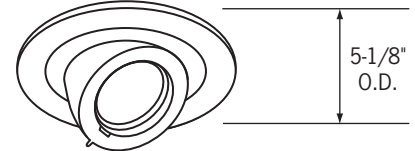

CTR1625-(B, NK, P)*1

Fully Adjustable Round/Round, Select Finish

87° vertical and 359° rotation adjustment. Die-cast aluminum construction. Front access, spring latch lamp retainer ring (black finish). 47mm lens. Depth From Ceiling: 2-1/2"

75W lamp may be used with LVR1675 housings.



CTR1629-(B, P)*1

Fully Adjustable Square/Square

87° vertical and 359° rotation adjustment. Die-cast aluminum construction. Front access, spring latch lamp retainer ring (black finish). 47mm lens. Depth From Ceiling: 2-5/8"

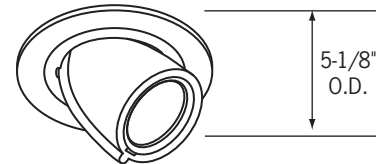

CTR1635-P*1

Fully Adjustable Round/Round

87° vertical and 359° rotation adjustment. Die-cast aluminum construction. Front access, spring latch lamp retainer ring (black finish). 47mm lens. Depth From Ceiling: 2-3/4"

Reflector/Trim Finish Legend

All finishes are not available for all trims.

Reflector Finish Options:

- CLR** - Clear, Specular
- BLK** - Black, Specular
- WHT** - White Light, Specular
- PL** - Platinum, Matte

Trim Finish Options:

- P** - White
- B** - Black
- C** - Chrome
- NK** - Nickel
- S** - Silver UNLook
- CO** - Brushed Copper
- ST** - Brushed Stainless Steel

NOTE: Black finish retainer ring standard on adjustable trims. Order part number 1623/24 WHITE for white retainer ring. These fully adjustable trims will only accept one lens. If FA-16 45MM louver is required, remove the safety lens and use a front glass MR16 lamp. A series of 47mm tempered color or light controlling lenses may be used instead of the clear lens supplied.

*Order part number SOCKET 1624/75 to convert trims for 75W housings.