

**Specifications/Features**

**Housing/Mounting**

White steel housing.  
Requires minimum 3" clearance around fixture from insulation material in insulated ceilings.  
Dual extension bars are adjustable for 16" and 24" center joists.  
Nailer bar hangers for easy installation. Hanger bars may be extended to rest on T-bar ceilings. Locking screw for bar hangers.  
Adjustable socket mounting plate. (Vertical position)

**Lamp/Electrical**

Input Voltage: 120V AC, 60Hz.  
(1) 60W A19, 65W BR30, 75W PAR30, 100W A19, 120W BR40, 150W PAR38 or 125W R40 Heat Lamp. (max.)  
Prewired junction box with convenient screwdriver pry-outs: (6) 1/2", (1) 1/2" x 3/4" concentric and (4) Romex knockouts.  
Spring-latch access plates.  
Quick connect, push-in wire connectors provided.  
Approved for through-branch (4 in/4 out) (8) #12 AWG wiring.

**Trims**

Many different trims options are available to complement any design style. See "Trims for 6" Incandescent Recessed Housings" spec sheet for details.

**Warranty**

This fixture is covered by ConTech's full one year replacement guarantee after date of purchase.

**Listing**

cCSAus Certified. Suitable for damp locations.

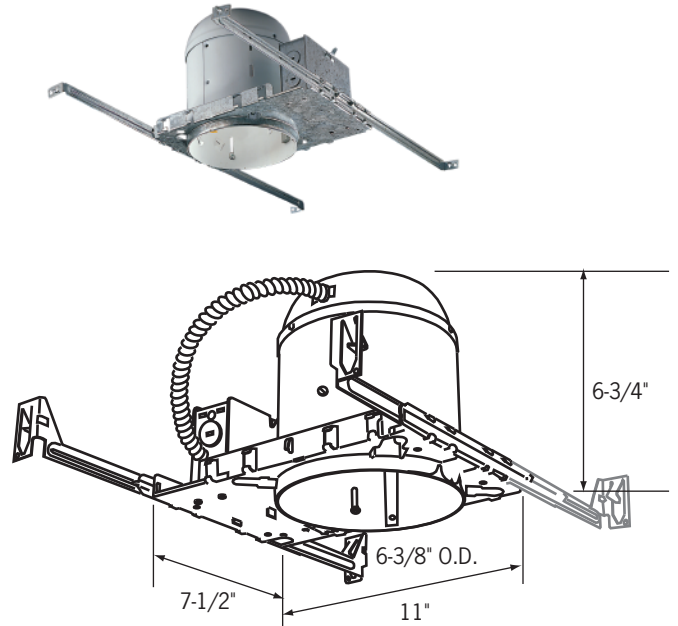

**Ceiling Opening:** 6-1/2"  
**Ceiling Thickness:** 1/2" - 1-1/2"

**Ordering Information**

Example Order:

Housing

RL38

Trims

**Max. Lamp 60W A19:**  
CTR1903, CTR1912, CTR1913 and CTR1916 Series Trims; CTR1331-P  
**Max. Lamp 65W BR30 or 75W PAR30:**  
CTR3000, CTR3001, CTR3002, CTR3007, CTR3008 and CTR3009 Series Trims  
**Max. Lamp 100W A19:**  
CTR1901 and CTR1902 Series Trims  
**Max. Lamp 120W BR40 or 150W PAR38:**  
CTR3800, CTR3801, CTR3802 and CTR3807 Series Trims  
**Max. Lamp 125W R40 Heat Lamp:**  
CTR62250-WHT Trim

See "Trims for 6" Incandescent Recessed Housings" Spec Sheet for Trim Information and Details

Options

**CP** - Chicago Plenum  
**CTR64C-CLR** - 6" Trim Cross-Hair Louver Insert  
**CTR618** - 6" Round Line Voltage Adapter Plate  
**HB-30** - 30" T-Bar Hanger Set  
**RL-725-(B,P)** - Minimum Trim Ring for 6" Trim, 7-1/4" O.D.  
**RL-75-(B,P)** - Replacement Trim Ring for 6" Trim, 7-1/2" O.D.  
**RL-08-(B,P)** - Oversized Trim Ring for 6" Trim, 7-13/16" O.D.

# Trims for 6" Incandescent RL30 and RL38 Series Recessed Housings

Catalog No. \_\_\_\_\_

Type \_\_\_\_\_

Project \_\_\_\_\_

All trims are compatible with 6" Incandescent Recessed Housings: RL30-IC, RL30S-IC, RL30-ICSA-R, RL30S-ICR, RL38, RL38S, RL38S-R, RL38-ICER and RL38-ICESA

**All trims have white trim finish unless specified.**

All trims are suitable for damp locations; only shower trims are listed for wet locations.

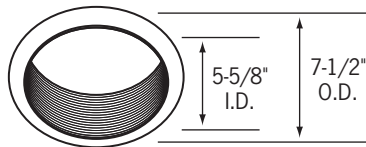

**CTR1901-B-CLR**

Black Baffle, Clear Reflector, Black Trim Ring

**CTR1901-CLR**

Black Baffle, Clear Reflector

**CTR1901-WHT**

White Baffle, White Reflector

White high heat rated ABS beveled trim ring. Specular aluminum reflector. (3) Heat-treated steel spring reflector clips.

**Maximum Wattage:**

IC Housings: 50W PAR30, 60W A19

Non-IC Housings: 75W PAR30, 90W PAR38, 100W A19

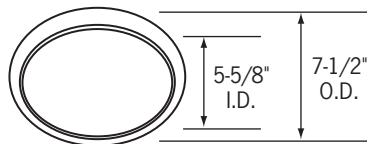

**CTR1902-(CLR, WHT)**

A-Lamp Multiplier, Clear or White Reflector

White high heat rated ABS beveled trim ring. Specular aluminum reflector. (3) Heat-treated steel spring pressure clips.

**Maximum Wattage:**

IC Housings: 50W PAR30, 60W A19

Non-IC Housings: 75W PAR30, 90W PAR38, 100W A19

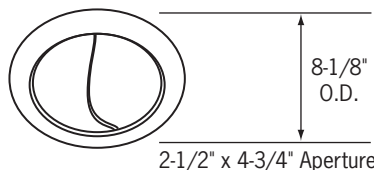

**CTR1903-P**

Scoop Wall Wash

White beveled steel trim ring. Polyethylene sponge gaskets. (2) Butterfly spring clips, heat-treated steel. All steel construction.

**Maximum Wattage:**

IC Housings: 40W A19 (60W A19 can be used in RL38-ICER and RL38-ICESA housings)

Non-IC Housings: 60W A19

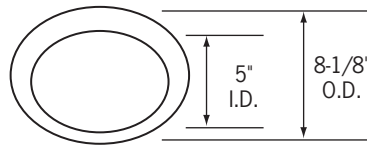

**CTR1912-P**

Albalite Shower Light Trim

Wet location listed. Beveled white steel trim ring. Polyethylene sponge gaskets. Flat opal Albalite glass. (2) Butterfly spring clips, heat treated steel.

**Maximum Wattage:**

IC Housings: 40W A19 (60W A19 can be used with RL38-ICER and RL38-ICESA housings)

Non-IC Housings: 60W A19

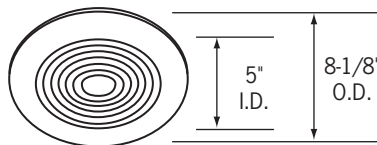

**CTR1913-P**

Fresnel Shower Light Trim

Wet location listed. Beveled white steel trim ring. Polyethylene sponge gaskets. Flat, clear Fresnel glass lens. (2) Butterfly spring clips, heat treated steel.

**Maximum Wattage:**

IC Housings: 40W A19 (60W A19 can be used with RL38-ICER and RL38-ICESA housings)

Non-IC Housings: 60W A19

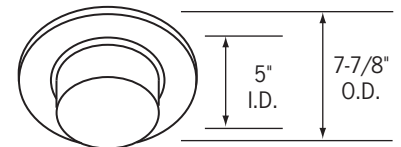

**CTR1916-PP**

Drop Opal Shower Light Trim

Plastic Lens, 1-1/2" Drop

Wet location listed. Beveled white high-heat ABS trim ring. Polyethylene sponge gaskets. (2) Butterfly spring clips, heat treated steel.

**Maximum Wattage:**

IC Housings: 40W A19

Non-IC Housings: 60W A19

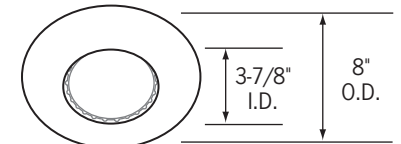

**CTR3000-P**

Open Trim

**Maximum Wattage:** 75W PAR30

**CTR3800-P**

Open Trim

**Maximum Wattage:**

IC Housings: 75W PAR38, 90W PAR38, 100W PAR38

Non-IC Housings: 120W BR40, 150W PAR38

Painted white steel beveled trim ring. Two double coiled heat-treated steel spring clips. Polyethylene sponge gaskets.

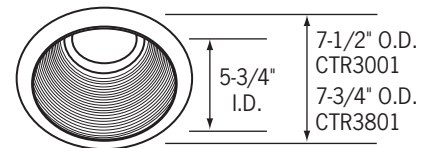

**CTR3001-(B, P, WHT)**

Tapered Black Baffle/Trim Ring, Black Baffle/White Trim Ring, or White Baffle/Trim Ring

**Maximum Wattage:** 65W BR30, 75W PAR30

**CTR3801-(B, P, WHT)**

Tapered Black Baffle/Trim Ring, Black Baffle/White Trim Ring, or White Baffle/Trim Ring

**Maximum Wattage:**

IC Housings: 75W PAR38, 90W PAR38, 100W PAR38

Non-IC Housings: 120W BR40, 150W PAR38

White high heat rated ABS beveled trim ring. (2) Double coiled heat-treated steel spring clips. Tapered steel baffle.

**Continued on Page 2**

**Trims for 6" Incandescent  
RL30 and RL38 Series  
Recessed Housings**

Catalog No. \_\_\_\_\_

Type \_\_\_\_\_

Project \_\_\_\_\_

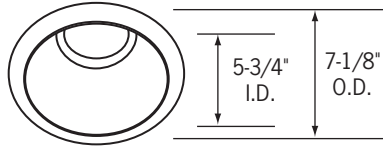

**CTR3002-B-BLK**  
Black Specular Reflector, Black Trim  
**Maximum Wattage:** 65W BR30, 75W PAR30

**CTR3002-(BLK, CLR)**  
Black or Clear Specular Reflector

**CTR3002-WHT**  
White Multiplier  
**Maximum Wattage:** 65W BR30, 75W PAR30

**CTR3802-B-BLK**  
Black Specular Reflector, Black Trim Ring  
**Maximum Wattage:**  
IC Housings: 75W PAR38, 90W PAR38, 100W PAR38  
Non-IC Housings: 120W BR40, 150W PAR38

**CTR3802-(BLK, CLR)**  
Black or Clear Specular Reflector

**CTR3802-WHT**  
White Multiplier  
**Maximum Wattage:**  
IC Housings: 75W PAR38, 90W PAR38, 100W PAR38  
Non-IC Housings: 120W BR40, 150W PAR38

White high heat rated ABS beveled trim ring. (2) Double coiled heat-treated steel spring clips. Tapered steel specular reflector on "BLK" finishes. Tapered aluminum specular reflector on "CLR" and "WHT" finishes.

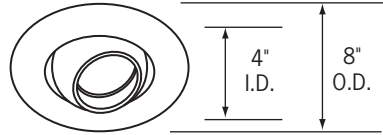

**CTR3008-P**  
Eyeball  
35° Vertical adjustment. Beveled steel trim ring. Polyethylene sponge gaskets. (2) Butterfly soring clips, heat-treated steel. Steel eyeball construction.  
**Maximum Wattage:** 75W PAR30

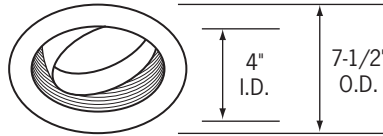

**CTR3009-WHT**  
Regressed Eyeball; White Baffle  
30° Vertical adjustment. Flat, high-heat ABS white trim ring. (3) Leaf reflector clips: spring steel, heat-treated, black oxidation plated. White aluminum tapered baffle. White steel eyeball construction.  
**Maximum Wattage:** 75W PAR30

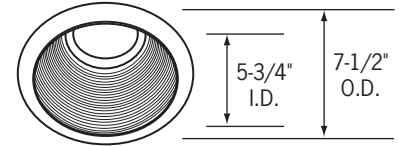

**CTR6001AT(B, WHT)**  
Self flanged, air-tight, tapered baffle. Black Baffle/Trim Ring or White Baffle/Trim Ring  
**Maximum Wattage:**  
IC Housings: 75W PAR30  
Non-IC Housings: 150W PAR38

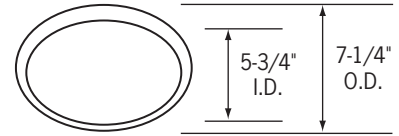

**CTR62250-WHT**  
Self Flanged Heat Lamp  
White steel trim.  
**For use with RL38 housing only.**  
**Maximum Wattage:** 125W R40 Heat Lamp

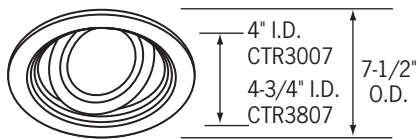

**CTR3007-P**  
Recessed Gimbal; Black Baffle

**CTR3007-WHT**  
Recessed Gimbal; White Baffle  
**Maximum Wattage:** 65W BR30, 75W PAR30

**CTR3807-P**  
Recessed Gimbal; Black Baffle

**CTR3807-WHT**  
Recessed Gimbal; White Baffle  
**Maximum Wattage:**  
IC Housings: 75W PAR38, 90W PAR38, 100W PAR38  
Non-IC Housings: 150W PAR38

23° Vertical adjustment. Flat, high heat ABS white trim ring. (3) Leaf reflector clips, spring steel, heat-treated. Steel baffle construction. Steel gimbal construction. (1) Steel, heat-treated lamp retaining spring.

**Reflector/Trim Finishes**

**Reflector Finish Options:**  
**BLK** - Black    **CLR** - Clear  
**WHT** - White

**Trim Finish Options:**  
**B** - Black    **PP** - White Plastic  
**P** - White  
**S** - Silver