

Description:

At 7.5 or 9 watts per foot, Cirrus Channel Wall Wash contains 85+ or 95+ CRI LEDs. Fixture mounts 24" from wall, and includes a split canopy that mounts on standard junction box. May be ordered with a Slim Profile Channel Junction Box (C-1RE-JBOX). Mounting clips are provided every 18 inches. Cirrus is powered by a Class 2 remote power supply up to 40 feet away. Available from 12 inches to 120 inches/10 feet (10DC) or to 144 inches/12 feet (7WDC). May be ordered in 3, 5, 8 or 10 inch increments. Lengths greater than 120 inches will ship as two or more segments that join together. Fixtures include a 5 year warranty.

Finishes:

Satin Nickel, Chrome, Antique Bronze, Satin Aluminum, White and Satin Black; Custom finishes available

Applications:

Wall wash, general lighting, retail and IP64 outdoor applications

Lamp:

Version	Watts per Foot	Lumens per Watt	Lumens per Foot	85+CRI 24K, 35K, 40K, 57K	95+CRI 27K, 30K	50,000 Hour Lamp Life
7WDC	7.5	37	278	•	•	•
10DC	9	43	387	•	•	•

Lumen values are based on the 3000K LED test.

Power Supply (24VDC):

- PSB-25W-010-24VDC** 120VAC input, 25 watt output
- PSB-96W-010-24VDC** 120-277VAC input, 96 watt output
- PSB-2X96W-010-24VDC** 120-277VAC input, 2x96 watt output
- PSB-3X96W-010-24VDC** 120-277VAC input, 3x96 watt output
- PSB-4X96W-010-24VDC** 120-277VAC input, 4x96 watt output
- PSB-60W-ELV-24VDC** 120VAC input, 60 watt output
- PSB-100W-ELV-24VDC** 120VAC input, 96 watt output
- PSB-2X100W-ELV-24VDC** 120VAC input, 2x96 watt output
- PSB-3X100W-ELV-24VDC** 120VAC input, 3x96 watt output
- PSB-4X100W-ELV-24VDC** 120VAC input, 4x96 watt output

Slim-Profile Junction Box (sold separately):

The Slim-Profile Junction Box with hanger bars mounts to studs spaced between 14.5"- 25" apart behind drywall. Allows low voltage DC wires from remote power supply to connect to channel wires. Junction box opening is covered by the fixture for a clean, safe connection. Includes a goof plate, for poor plastering around j-box, which may be plastered and painted.

Dimming:

010 power supplies use 0-10V dimmer: Philips Sunrise SR1200ZTUNV.
ELV power supplies use ELV dimmer: Legrand, Adorne ADTP703TU;
Lutron: Diva DVELV-300P, Skylark SELV-300P, Maestro MAELV-600 and Radio Ra 2

CIRRUS WALL WASH

CANDLEPOWER DISTRIBUTION

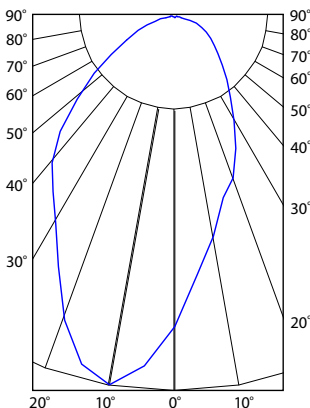

System: **C** Channel — Size: **1RE** 1" Rectangle — Product: **JBOX** Junction Box

System: **CC** Cirrus Channel — Lens: **WW** Wall Wash — Wattage/Voltage: **7WDC** 7.5 Watt 24 Volt DC / **10DC** 9 Watt 24 Volt DC — Length in Inches: **144IN** Order in 12 inch increments up to 120 inches (10DC) or 144 inches (7WDC). May be ordered in 3, 5, 8 or 10 inch increments — Color Temperature: **27K** 2700K Very Warm White / **24K** 2400K Amber White / **30K** 3000K Warm White / **35K** 3500K Neutral White / **40K** 4000K Cool White / **57K** 5700K Daylight White — Finish: **SN** Satin Nickel / **CH** Chrome / **BZ** Antique Bronze / **SA** Satin Aluminum / **BK** Satin Black / **WH** White — Options: **W** Wet Location (Up to 120")

CIRRUS CHANNEL WALL WASH 24VDC SYSTEM, 85+ OR 95+CRI

REV.10.12.15

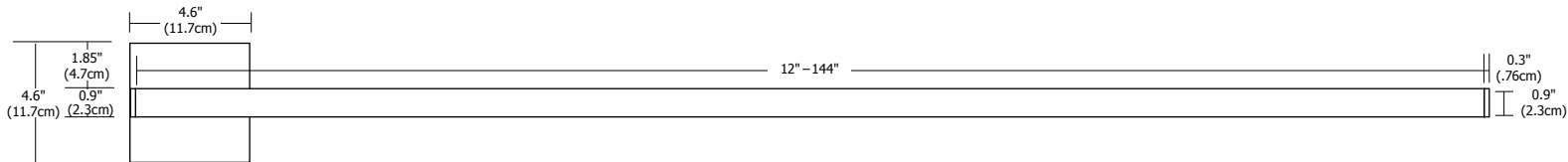

Split Canopy (included) with Cirrus Channel. May be mounted at End.

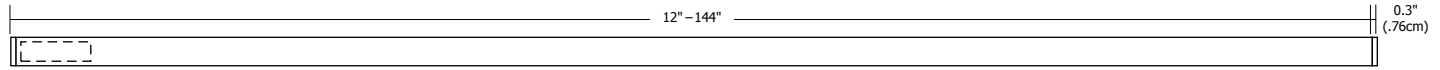

Shown with C-1RE-JBOX (sold separately)



Satin Aluminum Anodized



Satin Nickel Anodized



Antique Bronze Anodized



Satin Black Anodized



Chrome Plated



White Powder Coated

Application: 0-10V dimming for Cirrus Channel Wall Wash

Power Supply: Class 2, 24VDC output: 120VAC input, PSB-25W-010-24VDC; 120-277VAC input, PSB-96W-010-24VDC; PSB-2X96W-010-24VDC

Dimming: Dimmable with 0-10V dimmer: Philips Sunrise SR1200ZTUNV, 0-10V dimmer recommended

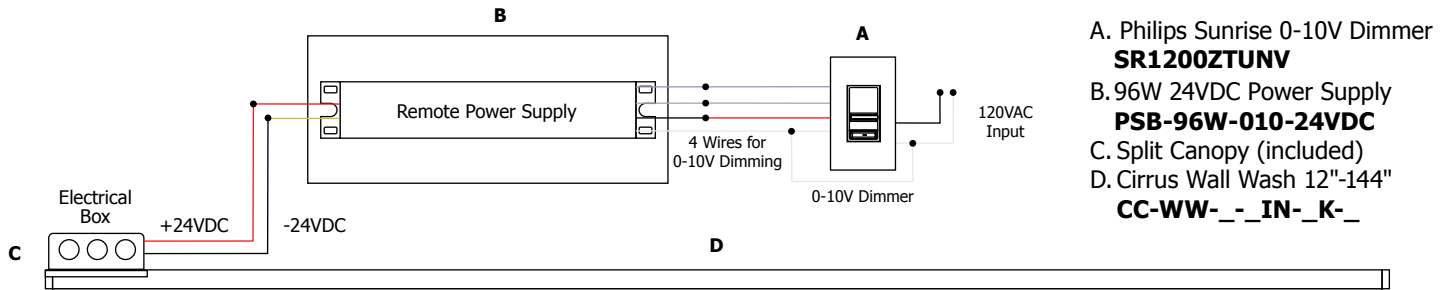

Fixture Mounted 24 inches from wall

1'	14	14	14	14	14	14
2'	25	25	25	25	25	25
3'	28	28	28	28	28	28
4'	22	22	22	22	22	22
5'	15	15	15	15	15	15
6'	11	11	11	11	11	11
7'	9	9	9	9	9	9
8'	5	5	5	5	5	5

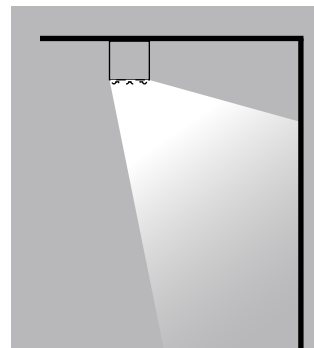

PROJECT:

FIXTURE TYPE:

DATE:

EDGE LIGHTING

CHANNEL L-SHIELD FOR CIRRUS WALL WASH AND WALL GRAZER

REV.10.12.15



Description:

The Channel L-Shield mounts to the ceiling along the Cirrus Wall Wash or Cirrus Wall Grazer fixtures (with C-1RE-JBOX only) to shield light brightness from view.

System	Product	Length	Finish
C	L2.5	10FT	WH
C Channel	L2.5 L- Shield 2.5" Height	10FT 10 Feet	WH White

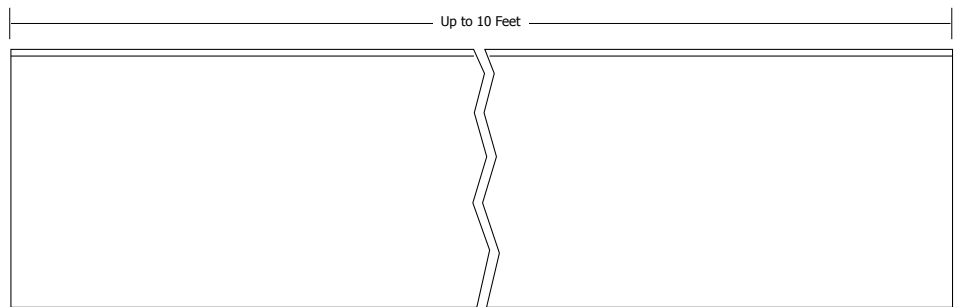
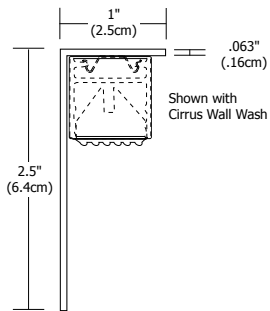

PROJECT:

FIXTURE
TYPE:

DATE:

Please refer to chart below for exact lengths of the Cirrus Channel Wall Wash

CODE	LENGTH (INCHES)
12IN	13.1
15IN	15.5
17IN	17.9
20IN	20.3
22IN	22.7
24IN	25.1
27IN	27.5
29IN	29.9
32IN	32.3
34IN	34.7
36IN	37.1
39IN	39.5
41IN	41.9
44IN	44.3
46IN	46.7
48IN	49.1
51IN	51.5
53IN	53.9
56IN	56.3
58IN	58.7
60IN	61.1
63IN	63.5
65IN	65.9
68IN	68.3
70IN	70.7
72IN	73.1
75IN	75.5
77IN	77.9

CODE	LENGTH (INCHES)
80IN	80.3
82IN	82.7
84IN	85.1
87IN	87.5
89IN	89.9
92IN	92.3
94IN	94.7
96IN	97.1
99IN	99.5
101IN	101.9
104IN	104.3
106IN	106.7
108IN	109.1
111IN	111.5
113IN	113.9
116IN	116.3
118IN	118.7
120IN	121.1
123IN	123.5
125IN	125.9
128IN	128.3
130IN	130.7
132IN	133.1
135IN	135.5
137IN	137.9
140IN	140.3
142IN	142.7
144IN	145.1

PROJECT:

FIXTURE
TYPE:

DATE:

