

Description:

Cirrus Channel Suspension T1 features a tubular lens with 100 degree beam spread. At 2.5 or 5 watts per feet, the 24VDC suspension contains 85+ or 95+CRI LEDs. Includes a 4 inch square canopy (additional Canopy options are available as accessories), a 12 feet power cable (for every run) and suspension cables (for support every 5 feet). It feeds power at the end using a standard junction box and must be wired into a Class 2 remote power supply up to 40 feet away. Available from 12 inches to 240 inches (5WDC) or 480 inches (2WDC). May be ordered in 3, 5, 8 or 10 inch increments. Lengths greater than 120 inches will ship as two or more segments that join together. Hardware and supporting cables are Antique Bronze for Antique Bronze and Black fixtures and are Satin Nickel for all other finishes. Power cables are Satin Nickel for all finish options. Fixtures include a 5 year warranty.

Finishes:

Satin Nickel, Chrome, Antique Bronze, Satin Aluminum, White and Satin Black Custom finishes available

Applications:

Indoor - Architectural lighting, general lighting and retail
Mount fixture 70 inch above finished floor

Lamp: 50,000 Hour Lamp Life

Version	Watts per Foot	Lumens		85+CRI 24K, 35K, 40K, 57K	95+CRI 27K, 30K
		per Watt	per Foot		
2WDC	2.5	61	153	●	●
5WDC	5	67	335	●	●

Lumen values are based on the 3000K LED test.

Remote Power Supplies* & Dimmers (Sold Separately):

- Electronic Low Voltage Dimming (ELV)
- 0-10 Volt Dimming (0-10V)
- Lutron

*In-Wall Mounting Kits available for select power supplies desired fixture location.

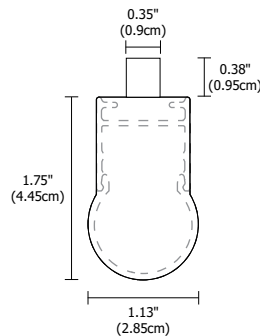

System	Lens	Wattage/Voltage	Nominal Sizes	Color Temperature	Finish
CCS	T1	2WDC	480IN	27K	SN
CCS Cirrus Channel Suspension	T1 Tubular 1.125" Lens	2WDC 2.5 Watt 24 Volt DC 5WDC 5 Watt 24 Volt DC	12-480 Order in 12 inch increments up to 240 inches (5W) or 480 (2.5W) May be ordered in 3, 5, 8 or 10 inch increments	24K 2400K Amber White 27K 2700K Very Warm White 30K 3000K Warm White 35K 3500K Neutral White 40K 4000K Cool White 57K 5700K Daylight White	SN Satin Nickel CH Chrome BZ Antique Bronze SA Satin Aluminum BK Satin Black WH White



CIRRUS CHANNEL SUSPENSION T1, TUBULAR 1" LENS 24VDC SYSTEM, 85+OR 95+CRI

REV03.14.17

ASSEMBLED IN THE USA

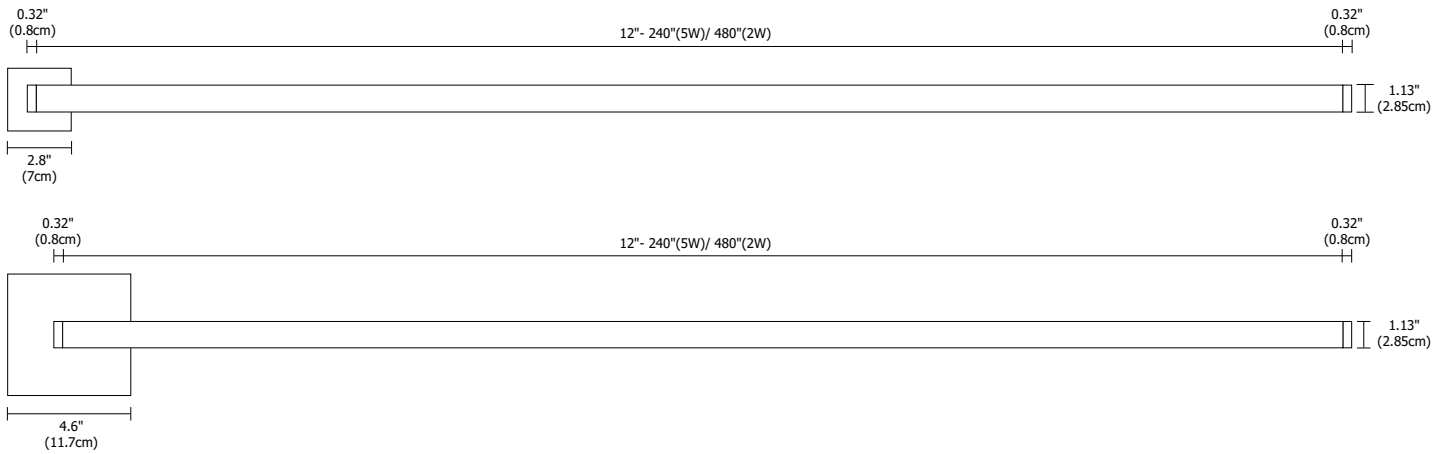

SA
Satin Aluminum



SN
Satin Nickel



BZ
Antique Bronze



BK
Satin Black



CH
Chrome



WH
White

Application: 0-10V dimming for Cirrus Suspension

Power Supply: Class 2, 24VDC output: 120VAC input, PSB-25W-010-24VDC;
120-277VAC input, PSB-96W-010-24VDC; PSB-2X96W-010 -24VDC

Dimming: Dimmable with 0-10V dimmer using power supplies above: Philips Sunrise SR1200ZTUNV, 0-10V dimmer recommended.

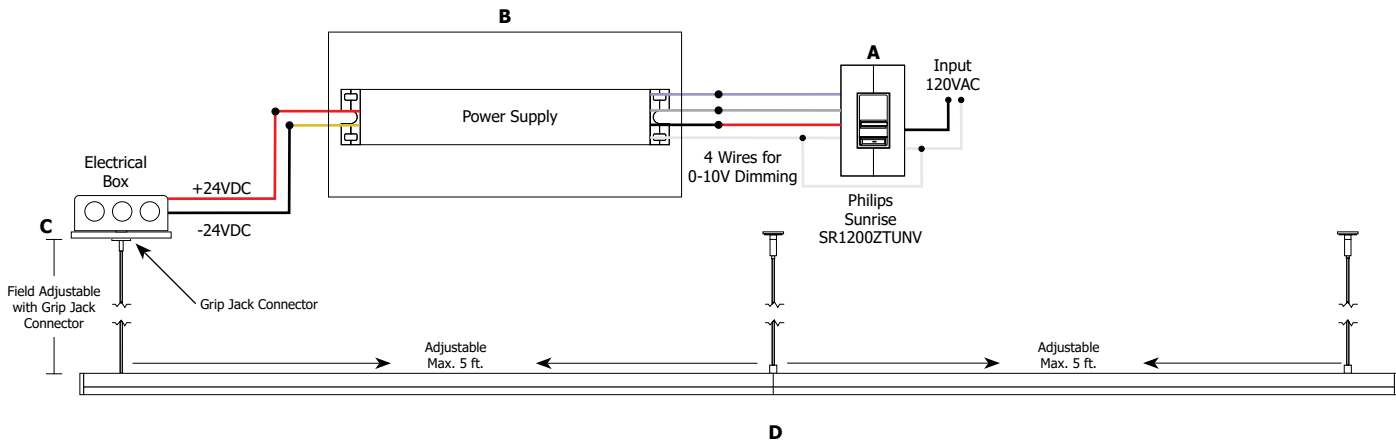

Warm White 100°		
Distance	Foot Candles 5W	Foot Candles 2.5W
2ft	126	71
3ft	62	35
4ft	39	22
6ft	20	12
8ft	12	7

- A. Philips Sunrise 0-10V Dimmer
SR1200ZTUNV
- B. 96W 24VDC Power Supply
PSB-96W-010-24VDC
- C. 4.6" Square Canopy (included)
- D. Cirrus T1 Channel Suspension 12"- 480"
CCS-T1-_WDC-_IN-_K_

PROJECT:

FIXTURE
TYPE:

DATE:



CIRRUS CHANNEL SUSPENSION T1, TUBULAR1" LENS ACTUAL SIZE

ORDERING CODE (NOMINAL SIZE)	LENGTH (INCHES)
12IN	13.1
15IN	15.5
17IN	17.9
20IN	20.3
22IN	22.7
24IN	25.1
27IN	27.5
29IN	29.9
32IN	32.3
34IN	34.7
36IN	37.1
39IN	39.5
41IN	41.9
44IN	44.3
46IN	46.7
48IN	49.1
51IN	51.5
53IN	53.9
56IN	56.3
58IN	58.7
60IN	61.1
63IN	63.5
65IN	65.9
68IN	68.3
70IN	70.7
72IN	73.1
75IN	75.5
77IN	77.9
80IN	80.3
82IN	82.7
84IN	85.1
87IN	87.5
89IN	89.9
92IN	92.3
94IN	94.7
96IN	97.1
99IN	99.5
101IN	101.9
104IN	104.3
106IN	106.7

ORDERING CODE (NOMINAL SIZE)	LENGTH (INCHES)
108IN	109.1
111IN	111.5
113IN	113.9
116IN	116.3
118IN	118.7
120IN	121.1
123IN	123.8
125IN	126.2
128IN	128.6
130IN	131
132IN	133.4
135IN	135.8
137IN	138.2
140IN	140.6
142IN	143
144IN	145.4
147IN	147.8
149IN	150.2
152IN	152.6
154IN	155
156IN	157.4
159IN	159.8
161IN	162.2
164IN	164.6
166IN	167
168IN	169.4
171IN	171.8
173IN	174.2
176IN	176.6
178IN	179
180IN	181.4
183IN	183.8
185IN	186.2
188IN	188.6
190IN	191
192IN	193.4
195IN	195.8
197IN	198.2
199IN	200.6
202IN	203

ORDERING CODE (NOMINAL SIZE)	LENGTH (INCHES)
204IN	205.4
207IN	207.8
209IN	210.2
212IN	212.6
214IN	215
216IN	217.4
219IN	219.8
221IN	222.2
224IN	224.6
226IN	227
228IN	229.4
231IN	231.8
233IN	234.2
236IN	236.6
238IN	239
240IN	241.4
243IN	244.1
245IN	246.5
248IN	248.9
250IN	251.3
252IN	253.7
255IN	256.1
257IN	258.5
260IN	260.9
262IN	263.3
264IN	265.7
267IN	268.1
269IN	270.5
272IN	272.9
274IN	275.3
276IN	277.7
279IN	280.1
281IN	282.5
284IN	284.9
286IN	287.3
288IN	289.7
291IN	292.1
294IN	294.5
296IN	296.9
298IN	299.3

PROJECT:

FIXTURE
TYPE:

DATE:



CIRRUS CHANNEL SUSPENSION T1, TUBULAR1" LENS ACTUAL SIZE

ORDERING CODE (NOMINAL SIZE)	LENGTH (INCHES)
300IN	301.7
303IN	304.1
305IN	306.5
308IN	308.9
310IN	311.3
312IN	313.7
315IN	316.1
317IN	318.5
320IN	320.9
322IN	323.3
324IN	325.7
327IN	328.1
329IN	330.5
332IN	332.9
334IN	335.3
336IN	337.7
339IN	340.1
341IN	342.5
344IN	344.9
346IN	347.3
348IN	349.7
351IN	352.1
353IN	354.5
355IN	356.9
358IN	359.3
360IN	361.7
363IN	364.4
365IN	366.8
368IN	369.2
370IN	371.6
372IN	374
375IN	376.4
377IN	378.8
380IN	381.2
382IN	383.6
384IN	386
387IN	388.4
389IN	390.8
392IN	393.2
394IN	395.6

ORDERING CODE (NOMINAL SIZE)	LENGTH (INCHES)
396IN	398
399IN	400.4
401IN	402.8
404IN	405.2
406IN	407.6
408IN	410
411IN	412.4
413IN	414.8
416IN	417.2
418IN	419.6
420IN	422
423IN	424.4
425IN	426.8
428IN	429.2
430IN	431.6
432IN	434
435IN	436.4
437IN	438.8
440IN	441.2
442IN	443.6
444IN	446
447IN	448.4
449IN	450.8
452IN	453.2
454IN	455.6
456IN	458
459IN	460.4
461IN	462.8
464IN	465.2
466IN	467.6
468IN	470
471IN	472.4
473IN	474.8
476IN	477.2
478IN	479.6
480IN	482





PROJECT:



FIXTURE
TYPE:

DATE:



REQUIRED COMPONENTS: 24VDC ELV Compatible Power Supplies.





ELECTRONIC LOW-VOLTAGE (ELV) POWER SUPPLIES & RECOMMENDED DIMMERS ¹					
ORDERING CODES	PS-40W-ELV-24VDC	PS-60L-ELV-24VDC	PSB-60W-ELV-24VDC*	PSB-2X60W-ELV-24VDC	PSB-100W-ELV-24VDC*
					
SPECIFICATIONS					
MAXIMUM LOAD	40W	60W	60W	2X60W	96W
INPUT VOLTAGE	120VAC	120VAC	120VAC	120VAC	120VAC
OUTPUT VOLTAGE	24VDC	24VDC	24VDC	24VDC	24VDC
DIMENSIONS	1.4" X 3" X 1"	2.25" X 1.25" X 0.83"	8.125" X 2" X 1.75"	12.15" X 6.48" X 2.18"	9.25" X 3.5" X 2"
CLASSIFICATION	CLASS 2	CLASS 2	CLASS 2	CLASS 2	CLASS 2
DIMMING AND CONTROLS					
LUTRON DIVA: DVELV-300P	•	•	•	•	•
LUTRON SKYLARK: SELV-300P	•	•	•	•	•
LUTRON RADIO RA2: RRD-6NA	N/A	N/A	•	•	•
LUTRON MAESTRO: MAELV-600	•	•	•	•	•
LEGRAND ADORNE: ADTP-703TUM4	N/A	N/A	•	•	•



ELECTRONIC LOW-VOLTAGE (ELV) POWER SUPPLIES & RECOMMENDED DIMMERS ¹			
ORDERING CODES	PSB-2X100W-ELV-24VDC*	PSB-3X100W-ELV-24VDC	PSB-4X100W-ELV-24VDC
			
SPECIFICATIONS			
MAXIMUM LOAD	2X96W	3X96W	4X96W
INPUT VOLTAGE	120VAC	120VAC	120VAC
OUTPUT VOLTAGE	24VDC	24VDC	24VDC
DIMENSIONS	12.15" X 6.48" X 2.18"	14" X 10" X 3"	17" X 13" X 3"
CLASSIFICATION	CLASS 2	CLASS 2	CLASS 2
DIMMING AND CONTROLS			
LUTRON DIVA: DVELV-300P	•	•	•
LUTRON SKYLARK: SELV-300P	•	•	•
LUTRON RADIO RA2: RRD-6NA	•	•	•
LUTRON MAESTRO: MAELV-600	•	•	•
LEGRAND ADORNE: ADTP-703TUM4	•	•	•

¹24K - 57K color temperatures are compatible with 0-10V, ELV, and Lutron Power Supplies.

*In-Wall Mounting Kits available for select power supplies.

REQUIRED COMPONENTS: 24VDC 0-10V Compatible Power Supplies.

0-10 VOLT (010) POWER SUPPLIES & RECOMMENDED DIMMERS ¹				
ORDERING CODES	PSB-25W-010-24VDC 	PSB-60W-010-24VDC* 	PSB-96W-010-24VDC* 	PSB-2X96W-010-24VDC* 
SPECIFICATIONS				
MAXIMUM LOAD	25W	60W	96W	2X96W
INPUT VOLTAGE	120VAC	120-277VAC	120-277VAC	120-277VAC
OUTPUT VOLTAGE	24VDC	24VDC	24VDC	24VDC
DIMENSIONS	12.4" X 3.12" X 2.18"	12.4" X 3.12" X 2.18"	12.4" X 3.12" X 2.18"	12.15" X 6.48" X 2.18"
CLASSIFICATION	CLASS 2	CLASS 2	CLASS 2	CLASS 2
DIMMING AND CONTROLS				
PHILIPS SUNRISE: SR1200ZTUNV	•	•	•	•
LUTRON DIVA:: DVTV-WH	•	•	•	•
LUTRON NOVA T: NTSTV-DV-XX	•	•	•	•
LUTRON GRAFIX EYE QS: QSGRJ-XP	•	•	•	•
LUTRON RADIO RA2: RRD-10ND	•	•	•	•
LEVITON: LEV40050	•	•	•	•
LEVITON IP710-DLX: IP710-DLX	•	•	•	•
LEGRAND: ADPD4FBL3P2W4	•	•	•	•

0-10 VOLT (010) POWER SUPPLIES & RECOMMENDED DIMMERS ¹		
ORDERING CODES	PSB-3X96W-010-24VDC 	PSB-4X96W-010-24VDC 
SPECIFICATIONS		
MAXIMUM LOAD	3X96W	4X96W
INPUT VOLTAGE	120-277VAC	120-277VAC
OUTPUT VOLTAGE	24VDC	24VDC
DIMENSIONS	14" X 10" X 3"	17" X 13" X 3"
CLASSIFICATION	CLASS 2	CLASS 2
DIMMING AND CONTROLS		
PHILIPS SUNRISE: SR1200ZTUNV	•	•
LUTRON DIVA: DVTV-WH	•	•
LUTRON NOVA T: NTSTV-DV-XX	•	•
LUTRON GRAFIX EYE QS: QSGRJ-XP	•	•
LUTRON RADIO RA2: RRD-10ND	•	•
LEVITON: LEV40050	•	•
LEVITON IP710-DLX: IP710-DLX	•	•
LEGRAND: ADPD4FBL3P2W4	•	•

¹24K - 57K color temperatures are compatible with 0-10V, ELV, and Lutron Power Supplies.

*In-Wall Mounting Kits available for select power supplies.

REQUIRED COMPONENTS: 24VDC Lutron Compatible Power Supply.

LUTRON HI-LUME® PREMIER .1% ECOSYSTEM® 3-WIRE POWER SUPPLY & RECOMMENDED CONTROLLERS ¹	
ORDERING CODES	<p>L3D0-96W24V-U</p> 
SPECIFICATIONS	
MAXIMUM LOAD	96W
INPUT VOLTAGE	120-277VAC
OUTPUT VOLTAGE	24VDC
DIMENSIONS	10.5" X 5.5" X 2"
CLASSIFICATION	CLASS 2
DIMMING AND CONTROLS	
RADIORA 2 DIMMER	•
HOMEWORKS QS DIMMER	•
PHPM-3F-120, PHPM-3F-DV AND BCI-0-10 INTERFACES	•

¹24K - 57K color temperatures are compatible with 0-10V, ELV, and Lutron Power Supplies.

CIRRUS CHANNEL SUSPENSION T1, TUBULAR 1" LENS ACCESSORIES

REV03.14.17

ASSEMBLED IN THE USA

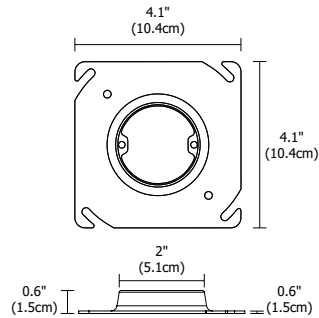

New Construction Junction Box Cover

Included with the 2 inch round and square canopies and is not required for the 4 inch square canopy. May be ordered separately as a rough-in component or replacement part. New Construction Junction Box Cover mounts to a standard 4 inch electrical box or octagon box, converting to a 2 inch plaster ring for new construction.

System	Type
NC2	JBOX
<small>NC2 New Construction 2"</small>	<small>JBOX JBox Cover</small>



2RD 2 Inch Round Canopy



2SQ 2 Inch Square Canopy

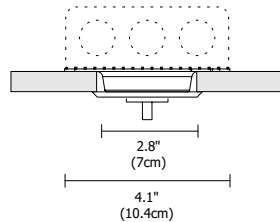

2 Inch Round or Square Canopy with Junction Box

The Cirrus Channel Linear Suspension includes a 4 inch Square Canopy; however, the 2 inch Round or Square Canopies are additional canopy options that can be ordered as accessories. The 2 inch Round or Square Canopy with Junction Box includes a special plaster ring that fits on a 4 inch square or octagon Junction Box.

Product	Size	Type	Finish
CCS	2SQ	JBOX	SN
<small>CCS Cirrus Channel Suspension</small>	<small>2SQ 2.8" Square 2RD 2.8" Round</small>	<small>JBOX Junction Box</small>	<small>SN Satin Nickel CH Chrome BZ Antique Bronze SA Satin Aluminum BK Satin Black WH White</small>

4 Inch Canopy (Not Included)

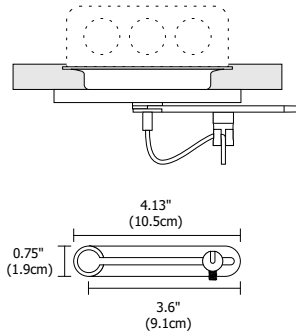

Cirrus Suspension Adjustable Swag Hook

Cirrus Suspension Adjustable Swag Hook allows a cable to form a straight connection to the channel when the Power Canopy is not located directly above the fixture. The Adjustable Swag Hook is compatible with the 2SQ, 2RD, and 4 inch square canopies. The Adjustable Swag Hook does not include canopy.

Product	Options	Type	Finish
CS	ADJ	SWAG	SN
<small>CS Channel Suspension</small>	<small>ADJ Adjustable</small>	<small>SWAG Swag Hook</small>	<small>SN Satin Nickel</small>

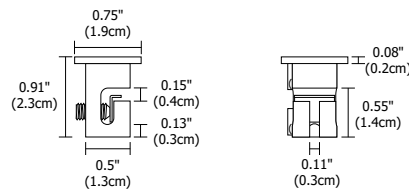

Channel Suspension Swag Hook

Swag Hook extends a cable to an electrical box that is not located directly above desired fixture location.

System	Type
CS	SWAG
<small>CS Channel Suspension</small>	<small>SWAG Swag Hook</small>

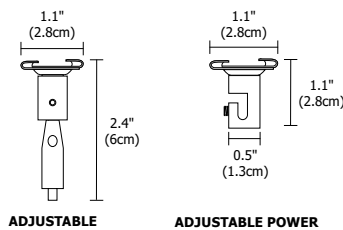

ADJUSTABLE

ADJUSTABLE POWER

Cirrus Suspension Adjustable T-Bar Clip

Cirrus Suspension Adjustable T-Bar Clip mounts rigid or adjustable Cirrus aircraft cables to T-Bar grid ceilings. Available as adjustable power and non-power versions.

Product	Type	Options	Finish
CS	TBAR	A	W
<small>CS Channel Suspension</small>	<small>TBAR 9/16" and 15/16"</small>	<small>A Adjustable AP Adjustable Power</small>	<small>W White B Black</small>

PROJECT:

FIXTURE
TYPE:

DATE:



TM-30-15 DATA: The data below is for SS2C and SS5C bare LED Soft Strips. Consistent color temperatures throughout a single strip and among multiple strips is possible through a 3 phase binning process in which each order is inspected with a color meter to ensure uniformity.

2400K | Rf: 83.9 | Rg: 94.9

COLOR VECTOR GRAPHIC

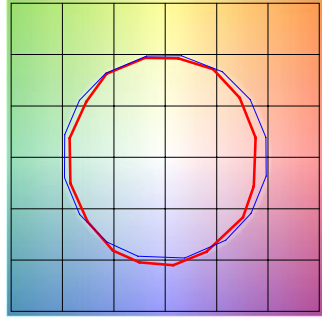

■ Test ■ Reference

HUE BIN	Rf	GRAPHIC SHIFTS %	
		CHROMA	HUE
1	77.6	-10.0%	1.8%
2	80.7	-7.5%	7.0%
3	79.5	-2.9%	8.9%
4	90.5	-3.1%	2.4%
5	93.9	-1.3%	1.9%
6	91.9	-0.9%	-0.2%
7	87.6	-6.3%	-2.7%
8	90.5	-5.4%	2.7%
9	83.8	-4.7%	6.5%
10	81.2	-2.5%	10.0%
11	83.3	3.9%	9.4%
12	86.4	5.6%	2.6%
13	86.2	4.5%	-12.4%
14	64.3	-1.0%	-21.9%
15	85.1	-4.4%	-7.5%
16	75.0	-9.9%	-12.0%

2700K | Rf: 87.7 | Rg: 96.1

COLOR VECTOR GRAPHIC

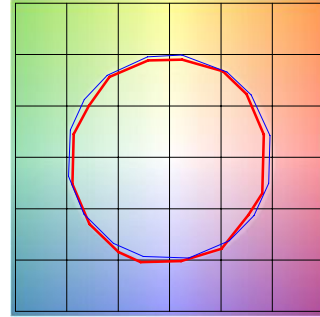

■ Test ■ Reference

HUE BIN	Rf	GRAPHIC SHIFTS %	
		CHROMA	HUE
1	86.4	-5.6%	2.3%
2	89.7	-3.3%	3.1%
3	90.5	-1.5%	3.8%
4	90.0	-4.3%	1.1%
5	92.9	-3.7%	0.2%
6	93.5	-2.5%	-0.8%
7	86.3	-7.2%	2.5%
8	90.7	-4.0%	3.2%
9	85.2	-2.4%	8.1%
10	81.7	0.9%	10.8%
11	85.4	4.5%	8.9%
12	88.7	5.7%	-1.4%
13	88.3	1.3%	-7.9%
14	85.1	2.4%	-10.4%
15	88.1	-4.8%	-2.7%
16	81.7	-4.3%	-10.9%

3000K | Rf: 88.1 | Rg: 99.7

COLOR VECTOR GRAPHIC

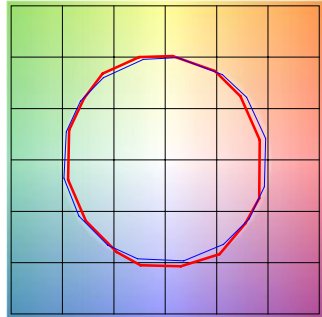

■ Test ■ Reference

HUE BIN	Rf	GRAPHIC SHIFTS %	
		CHROMA	HUE
1	87.7	-5.9%	-0.3%
2	87.9	-4.4%	4.3%
3	82.9	-1.2%	7.9%
4	89.9	0.6%	4.7%
5	92.7	3.0%	3.5%
6	92.7	3.6%	-1.7%
7	90.8	-1.3%	-4.4%
8	93.7	-2.5%	-2.2%
9	91.7	-3.7%	2.3%
10	85.5	-2.8%	7.8%
11	83.3	0.7%	11.0%
12	86.4	5.5%	3.8%
13	90.6	4.6%	-3.6%
14	85.6	5.9%	-8.4%
15	89.5	-0.6%	-5.7%
16	82.6	-2.7%	-12.0%

3500K | Rf: 86.1 | Rg: 95.5

COLOR VECTOR GRAPHIC

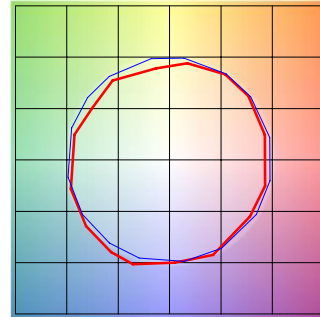

■ Test ■ Reference

HUE BIN	Rf	GRAPHIC SHIFTS %	
		CHROMA	HUE
1	86.6	-4.2%	3.4%
2	91.7	-1.4%	1.8%
3	94.9	-0.7%	0.4%
4	87.9	-4.5%	-4.1%
5	85.9	-10.3%	-2.7%
6	89.8	-5.2%	-0.4%
7	79.6	-9.5%	6.5%
8	87.6	-4.0%	5.7%
9	81.4	-0.5%	11.8%
10	78.3	3.3%	11.4%
11	85.7	6.3%	6.1%
12	86.3	7.1%	-4.6%
13	86.1	-0.7%	-9.6%
14	85.1	0.8%	-10.4%
15	83.4	-4.1%	-5.3%
16	82.5	-3.6%	-5.7%

4000K | Rf: 87.6 | Rg: 96.8

COLOR VECTOR GRAPHIC

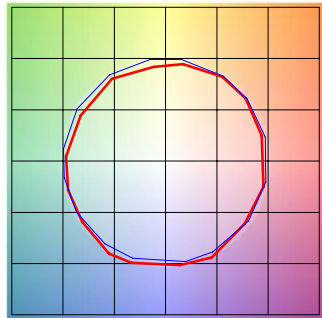

■ Test ■ Reference

HUE BIN	Rf	GRAPHIC SHIFTS %	
		CHROMA	HUE
1	89.0	-3.1%	2.1%
2	93.2	-0.9%	1.3%
3	94.3	-1.1%	0.7%
4	89.5	-4.0%	-2.3%
5	87.6	-7.8%	-1.8%
6	92.2	-4.6%	0.1%
7	87.4	-6.6%	3.6%
8	85.7	-3.8%	7.0%
9	81.5	-1.3%	12.4%
10	80.0	0.9%	11.4%
11	83.3	5.9%	8.7%
12	89.7	4.8%	-0.3%
13	88.5	2.4%	-6.3%
14	92.7	4.0%	-3.8%
15	86.1	-1.6%	-4.5%
16	85.0	-1.4%	-5.0%

5700K | Rf: 80.3 | Rg: 91.5

COLOR VECTOR GRAPHIC

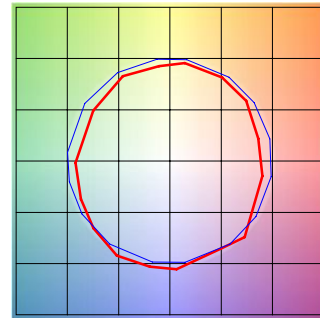

■ Test ■ Reference

HUE BIN	Rf	GRAPHIC SHIFTS %	
		CHROMA	HUE
1	73.8	-11.2%	2.6%
2	83.7	-5.5%	5.8%
3	84.2	-4.0%	5.5%
4	85.8	-3.5%	1.3%
5	85.3	-7.1%	0.6%
6	89.2	-5.8%	-2.2%
7	81.5	-10.7%	1.2%
8	75.7	-9.7%	8.5%
9	74.9	-7.8%	18.8%
10	67.8	-1.6%	18.0%
11	76.1	5.5%	12.0%
12	90.8	4.9%	-1.6%
13	83.6	5.0%	-9.5%
14	81.7	-1.2%	-10.0%
15	69.0	2.0%	-22.8%
16	83.2	-8.5%	-1.0%