

# CIRRUS CHANNEL SUSPENSION R1, RECTANGULAR 1" LENS 24VDC SYSTEM, 85+ OR 95+CRI

REV.06.22.16

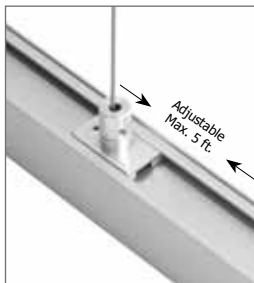

MADE IN THE USA

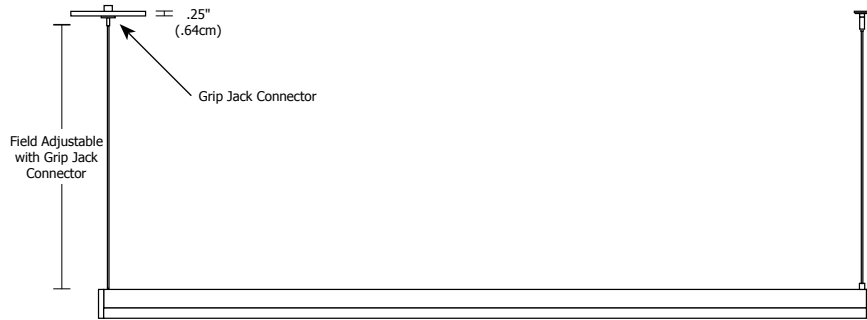

## Description:

Cirrus Channel Suspension R1 features a rectangular lens with 100 degree beam spread. At 2.5 or 5 watts per ft, the 24VDC suspension contains 85+ or 95+CRI LEDs. Includes a 4" square canopy, a 12 ft power cable (for every run) and suspension cables (for support every 5 ft). It feeds power at the end using a standard junction box and must be wired into a Class 2 remote power supply up to 40 ft away. Available from 12 inches to 240 inches (5WDC) or 480 inches (2WDC). May be ordered in 3, 5, 8 or 10 inch increments. Lengths greater than 120 inches will ship as two or more segments that join together. Hardware and supporting cables are Antique Bronze for Antique Bronze and Black fixtures and are Satin Nickel for all other finishes. Power cables are Satin Nickel for all finish options. Fixtures include a 5 year warranty.

## Finishes:

Satin Nickel, Chrome, Antique Bronze, Satin Aluminum, White and Satin Black Custom finishes available

## Applications:

Indoor - Architectural lighting, general lighting and retail  
Mount fixture 70" above finished floor

## Lamp:

Version	Watts per Foot	Lumens		85+CRI	95+CRI	50,000 Hour Lamp Life
		per Watt	per Foot			
2WDC	2.5	62	155	•	•	•
5WDC	5	65	325	•	•	•

Lumen values are based on the 3000K LED test.

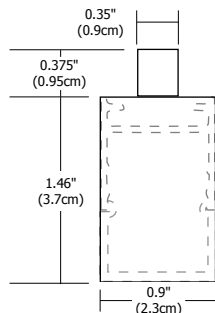

## 24VDC Power Supply (sold separately):

- PSB-25W-010-24VDC** 120VAC input, 25 watt output
- PSB-96W-010-24VDC** 120-277VAC input, 96 watt output
- PSB-2X96W-010-24VDC** 120-277VAC input, 2x96 watt output
- PSB-3X96W-010-24VDC** 120-277VAC input, 3x96 watt output
- PSB-4X96W-010-24VDC** 120-277VAC input, 4x96 watt output
- PS-40W-ELV-24VDC** 120VAC input, 40 watt output
- PSB-60W-ELV-24VDC** 120VAC input, 60 watt output
- PSB-100W-ELV-24VDC** 120VAC input, 96 watt output
- PSB-2X100W-ELV-24VDC** 120VAC input, 2x96 watt output
- PSB-3X100W-ELV-24VDC** 120VAC input, 3x96 watt output
- PSB-4X100W-ELV-24VDC** 120VAC input, 4x96 watt output

## Dimming:

010 power supplies use 0-10V dimmer: Philips Sunrise SR1200ZTUNV.  
ELV power supplies use ELV dimmer: Legrand, Adorne ADTP703TU;  
Lutron: Diva DVELV-300P, Skylark SELV-300P, Maestro MAELV-600 and Radio Ra 2

## Channel Suspension Swag Hook (sold separately):

Swag Hook extends a cable to an electrical box that is not located directly above desired fixture location.

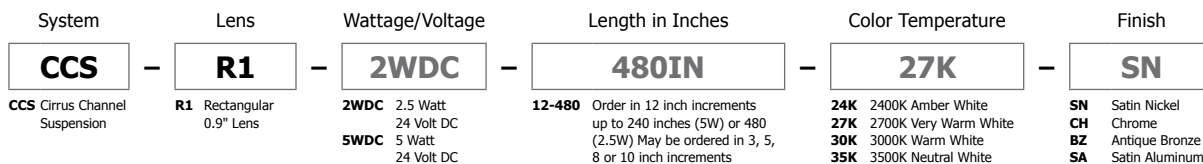
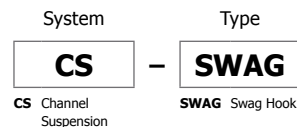

PROJECT:

FIXTURE TYPE:

DATE:



# CIRRUS CHANNEL SUSPENSION R1, RECTANGULAR 1" LENS 24VDC SYSTEM, 85+ OR 95+CRI

REV.06.22.16

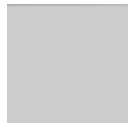
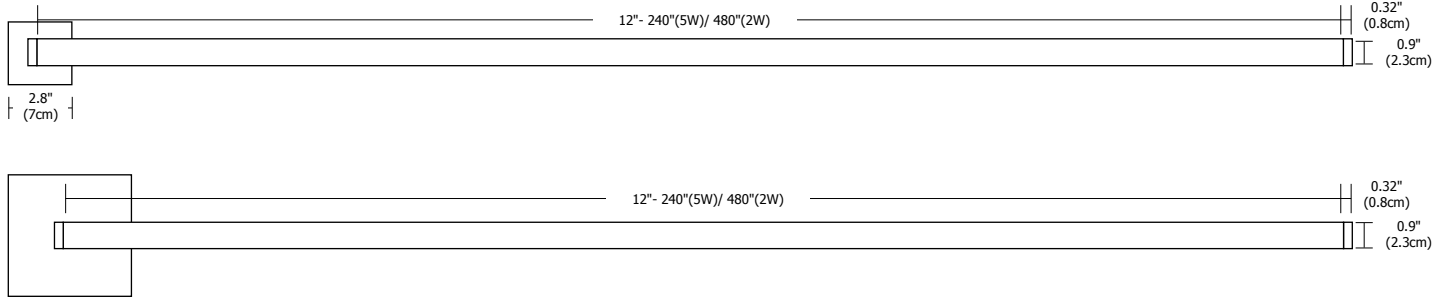

Satin Aluminum Anodized



Satin Nickel Anodized



Antique Bronze Anodized



Satin Black Anodized



Chrome Plated



White Powder Coated

**Application:** 0-10V dimming for Cirrus Suspension

**Power Supply:** Class 2, 24VDC output: 120VAC input, PSB-25W-010-24VDC; 120-277VAC input, PSB-96W-010-24VDC; PSB-2X96W-010 -24VDC

**Dimming:** Dimmable with 0-10V dimmer using power supplies above: Philips Sunrise SR1200ZTUNV, 0-10V dimmer recommended.

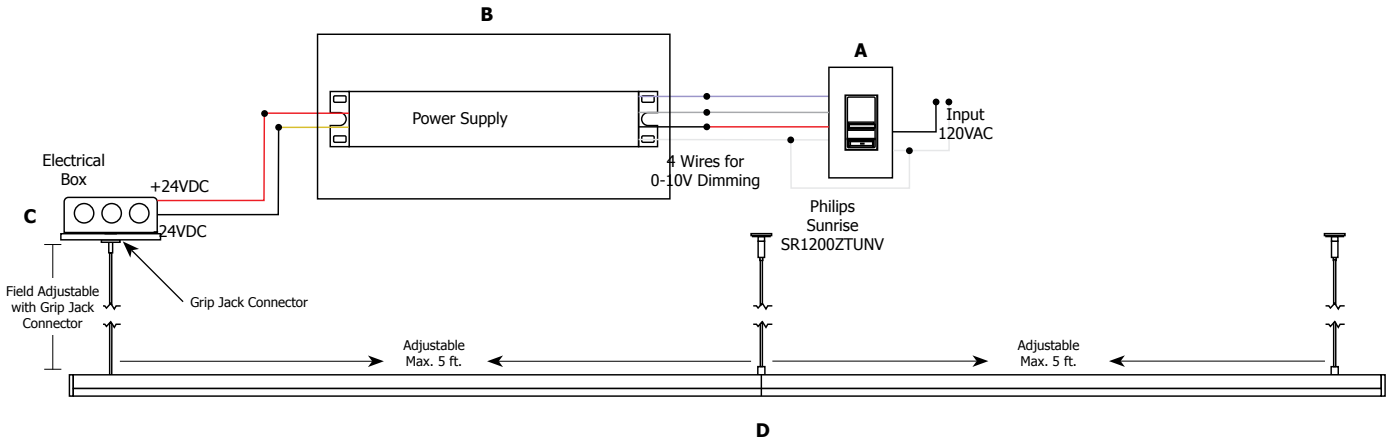

Warm White 100°		
Distance	Foot Candles 5W	Foot Candles 2.5W
2ft	126	71
3ft	62	35
4ft	39	22
6ft	20	12
8ft	12	7

A. Philips Sunrise 0-10V Dimmer  
**SR1200ZTUNV**

B. 96W 24VDC Power Supply  
**PSB-96W-010-24VDC**

C. 4.6" Square Canopy (included)

D. Cirrus R1 Channel Suspension 12"- 480"  
**CCS-R1- \_WDC- \_IN- \_K- \_**

PROJECT:

FIXTURE  
TYPE:

DATE:

**EDGE**  
LIGHTING

Please refer to chart below for exact lengths of the Cirrus Channel Suspension R1, Rectangular 1" Lens.

CODE	LENGTH (INCHES)	CODE	LENGTH (INCHES)	CODE	LENGTH (INCHES)	CODE	LENGTH (INCHES)	CODE	LENGTH (INCHES)
12IN	13.1	108IN	109.1	204IN	205.4	300IN	301.7	396IN	398
15IN	15.5	111IN	111.5	207IN	207.8	303IN	304.1	399IN	400.4
17IN	17.9	113IN	113.9	209IN	210.2	305IN	306.5	401IN	402.8
20IN	20.3	116IN	116.3	212IN	212.6	308IN	308.9	404IN	405.2
22IN	22.7	118IN	118.7	214IN	215	310IN	311.3	406IN	407.6
24IN	25.1	120IN	121.1	216IN	217.4	312IN	313.7	408IN	410
27IN	27.5	123IN	123.8	219IN	219.8	315IN	316.1	411IN	412.4
29IN	29.9	125IN	126.2	221IN	222.2	317IN	318.5	413IN	414.8
32IN	32.3	128IN	128.6	224IN	224.6	320IN	320.9	416IN	417.2
34IN	34.7	130IN	131	226IN	227	322IN	323.3	418IN	419.6
36IN	37.1	132IN	133.4	228IN	229.4	324IN	325.7	420IN	422
39IN	39.5	135IN	135.8	231IN	231.8	327IN	328.1	423IN	424.4
41IN	41.9	137IN	138.2	233IN	234.2	329IN	330.5	425IN	426.8
44IN	44.3	140IN	140.6	236IN	236.6	332IN	332.9	428IN	429.2
46IN	46.7	142IN	143	238IN	239	334IN	335.3	430IN	431.6
48IN	49.1	144IN	145.4	240IN	241.4	336IN	337.7	432IN	434
51IN	51.5	147IN	147.8	243IN	244.1	339IN	340.1	435IN	436.4
53IN	53.9	149IN	150.2	245IN	246.5	341IN	342.5	437IN	438.8
56IN	56.3	152IN	152.6	248IN	248.9	344IN	344.9	440IN	441.2
58IN	58.7	154IN	155	250IN	251.3	346IN	347.3	442IN	443.6
60IN	61.1	156IN	157.4	252IN	253.7	348IN	349.7	444IN	446
63IN	63.5	159IN	159.8	255IN	256.1	351IN	352.1	447IN	448.4
65IN	65.9	161IN	162.2	257IN	258.5	353IN	354.5	449IN	450.8
68IN	68.3	164IN	164.6	260IN	260.9	355IN	356.9	452IN	453.2
70IN	70.7	166IN	167	262IN	263.3	358IN	359.3	454IN	455.6
72IN	73.1	168IN	169.4	264IN	265.7	360IN	361.7	456IN	458
75IN	75.5	171IN	171.8	267IN	268.1	363IN	364.4	459IN	460.4
77IN	77.9	173IN	174.2	269IN	270.5	365IN	366.8	461IN	462.8
80IN	80.3	176IN	176.6	272IN	272.9	368IN	369.2	464IN	465.2
82IN	82.7	178IN	179	274IN	275.3	370IN	371.6	466IN	467.6
84IN	85.1	180IN	181.4	276IN	277.7	372IN	374	468IN	470
87IN	87.5	183IN	183.8	279IN	280.1	375IN	376.4	471IN	472.4
89IN	89.9	185IN	186.2	281IN	282.5	377IN	378.8	473IN	474.8
92IN	92.3	188IN	188.6	284IN	284.9	380IN	381.2	476IN	477.2
94IN	94.7	190IN	191	286IN	287.3	382IN	383.6	478IN	479.6
96IN	97.1	192IN	193.4	288IN	289.7	384IN	386	480IN	482
99IN	99.5	195IN	195.8	291IN	292.1	387IN	388.4		
101IN	101.9	197IN	198.2	294IN	294.5	389IN	390.8		
104IN	104.3	199IN	200.6	296IN	296.9	392IN	393.2		
106IN	106.7	202IN	203	298IN	299.3	394IN	395.6		

PROJECT:

FIXTURE  
TYPE:

DATE:

