

Installation Instructions for **DVR-RGB-60**

SAVE THESE INSTRUCTIONS!

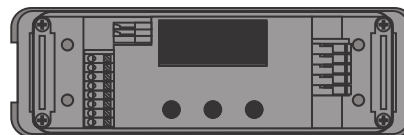

1: Product Description

DVR-RGB-60 are highly integrated, enclosed and easy-to-configure direct voltage controlled driver/controllers for low-power, indoor LED lighting applications.

DVR-RGB-60 can be integrated in a network or used as standalone devices.

DVR-RGB-60 are DMX compatible.

1.1: Setup is a Breeze

Configure the DVR-RGB-60 over its intuitive, 3-button user interface with display. The easy-to navigate menu allows you to set parameters such as number of channels, DMX settings for networked mode and show/colour/dim values for standalone operation. You can also lock the driver's configuration and perform a test run of the connected LED groups.

1.2: Robust Thermal Management

Built-in over temperature protection protects the DVR-RGB-60 against overheating.

1.3: Low EMI

DVR-RGB-60 EMI is very low due to the implementation of slew-rate controlled dimming and shielded conductors.

1.4: Easy to Connect

Connecting the DVR-RGB-60 is self-explanatory: the spring-cage connectors for LEDs, power and network leads are all clearly marked.

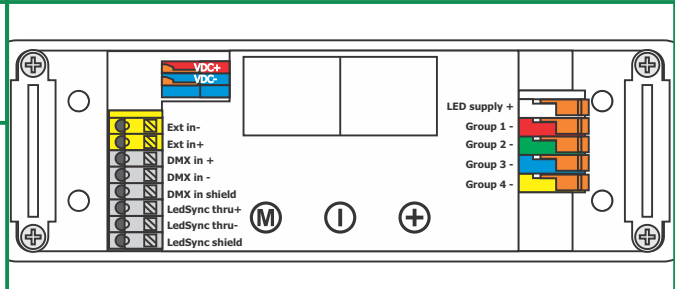

Strain reliefs prevent leads from being pulled out by accident.

2: Mounting the driver/controller

2.1: Realizing the right thermal conditions

DVR-RGB-60 can be operated without a heat sink, as its own heat generation always stays within an acceptable temperature range.

The general rule of thumb you can use when calculating a heat sink's required dissipating capabilities is that an Edge Lighting driver/controller adds 10% at the very most to the power consumption of the connected LEDs. In other words, if the connected LEDs consume 90W, the driver/controller will add a maximum of 9W: the heat sink will have to be able to deal with a total of 99W.

It is recommended to keep ambient temperature values between -20°C and +50°C (-4°F and +122°F).

2.2: Removing the Cover

To remove the driver/controller's cover:

1. Hold off the driver/controller as indicated by arrows.
2. Pull the cover off the base unit in the upward movement.



2.3: Preparing the Mounting Surface

DVR-RGB-60 can be mounted onto wood, plastic or metal. If you need to pre-drill mounting holes into the mounting surface or heat sink:

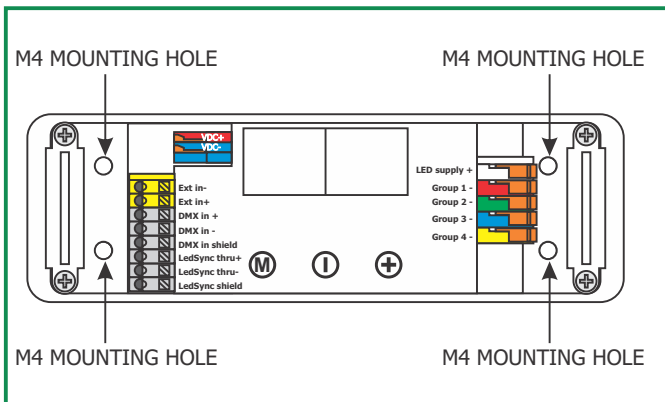

1. Remove the DVR-RGB-60 cover.
2. Place the DVR-RGB-60 onto the mounting surface in the desired position.
3. Indicate the position of the mounting holes on the surface by drawing them through the DVR-RGB-60 M4 mounting holes with a pencil.
4. Take away the DVR-RGB-60 and pre-drill the screw holes in the mounting surface.

2.4: Fastening the driver/controller to the surface

To fasten the driver/controller to the mounting surface:



1. The DVR-RGB-60 has four mounting holes suited for M4 screws. Make sure you have four screws that are appropriate for the surface that you want to mount the driver/controller onto. Use mounting screws with a minimum length of 15mm.
2. Place the DVR-RGB-60 in the desired location, matching the DVR-RGB-60's mounting holes with the predrilled screw holes on the mounting surface.
3. With a screwdriver, fasten the driver/controller to the surface.

The DVR-RGB 60 must be mounted according to the requirements of local legislation.

It is recommended to mount Edge Lighting products in accordance with the IPC-A620 standards.

3: Connecting the driver/controller

This section tells you how to connect the power supply, network and LED leads to the driver/controller, and lists information regarding wire sizes

3.1: Required wire sizes

The following diagram lists the required wire sizes for the various connectors and the length of insulation material you need to strip away from the leads.

The diameter of the wires including insulation material should be the same for all wires on the same side. The diameter of the wires including insulation material should be between 0.99mm and 3.12mm.

DVR-RGB-60			
CONNECTOR	WIRE CORE DIAMETER IN MM	AWG	INSULATION MATERIAL TO BE STRIPPED AWAY IN MM
VDC	0.14 - 0.5	26 - 20	11
EXT in	0.5 - 1.5	20 - 16	9
DMX in	0.5 - 1.5	20 - 16	9
LEDSYNC THRU	0.5 - 1.5	20 - 16	9
LED (GROUP X)	0.14 - 1	26 - 18	10

3.2: Removing the strain relief

Strain reliefs prevent leads from being pulled out by accident. Before you can connect any leads, you need to remove the strain reliefs.



1. Remove the cover
2. Use a phillips crosshead screwdriver to unscrew the screws that fasten the strain reliefs to the base unit.
3. Take the strain reliefs out.

3.3: Connecting the leads

This section first explains in general how to go about connecting a lead to the DVR-RGB-60 and then goes on to describe the specific spring cage connectors.

1. Locate the correct connector for the lead that you wish to connect. The connectors are clearly marked on the base unit.
2. Strip away the insulation material from the tip of the lead. Refer to the tables in 3.1 "Required wire sizes" for information on the length of insulation material that you need to strip away. Stripping away too little insulation material can result in a poor or loose connection.
3. Using a small flat screw driver (2mm wide) or your fingernail, push down the top of the spring cage connector.
4. While pressing down the top of the spring cage connector, insert the stripped part of the lead into the connector.
5. Release the top of the spring cage connector.
6. Repeat steps 1 through 5 for all leads that you wish to connect.

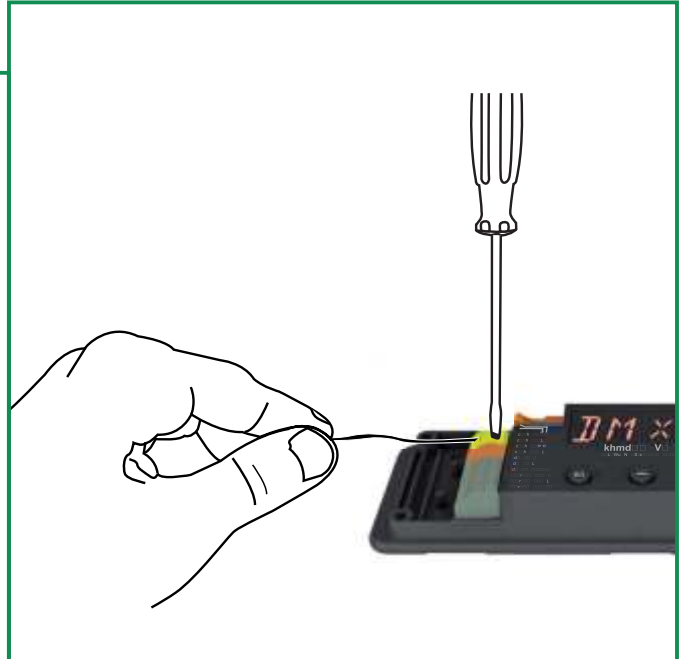



3.3.1: Connecting power leads

Connect the positive voltage supply wire of the 12VDC power supply to the VDC+ connector, and the negative voltage supply wire to the VDC- connector.

The power leads should have an insulating capacity of 100 volts or more, and the leads' insulation must be able to withstand temperatures of 85°C or more.

3.3.1.1: Connecting DMX network cabling

The data wires must be connected to the DMX and LedSync connectors.

For data input on both DVR-RGB-60, connect the network cable's data+, data- and shielding wire (the orange, orange/white and brown wire in a CAT5 cable) to the DMX in+, DMX in- and DMX in shield connector respectively.

For data output on DVR-RGB-60, connect the network cable's data+, data- and shielding wire (the orange, orange/white and brown wire in a CAT5 cable) to the LedSync thru+, LedSync thru- and LedSync thru shield wire respectively.

LedSync is the eldoLED proprietary communication protocol that is 100% DMX512A-compatible, and enables additional features such as a 15-bit control resolution and bidirectional communication for driver configuration and temperature read-out.

For DMX wires, use CAT5 Shielded Twisted Pair cabling or equivalent.

3.3.1.2: Connecting LED groups

- to the LED supply and Group x connectors on the DVR-RGB-60 right side

3.3.1.3: Connecting LED groups

The length of the wires between the DVR-RGB-60 and the light engine (the LEDs) should not exceed 3m. Beyond this length, the resolution and contrast rate cannot be guaranteed.

3.4: Replacing the strain relief



1. On both sides of the DVR-RGB-60, make sure the leads run between the strain reliefs screw holes.
2. Place the strain relief over the leads.
3. Fasten the strain reliefs' screws.
4. Replace the DVR-RGB-60's cover.

4: Configuring the driver/controller

Configure the driver/controller over its intuitive, 3-button user interface with display. The easy to-navigate menu allows you to set parameters such as number of LED groups, DMX network settings for networked mode and show/colour/dim values for standalone operation. You can also lock the driver's configuration and perform a test run of the connected LED groups. This chapter explains how to work with the menu buttons and display, and lists the various menu items and selectable values.

4.1: Working with the menu buttons and display

The driver/controller features three menu buttons (M, - and +) with which you can navigate the configuration menu. The display above the menu buttons shows the menu item names and values that can be selected for every item.

In order to prevent an unlocked driver/controller's configuration from being accidentally changed by objects touching the menu buttons, the menu buttons are sunk into the cover. For easy access to the buttons when you are doing a complete configuration, it is recommended to remove the cover. If you only need to change one setting, such as changing a color or show sequence, you can leave the cover on and press the menu buttons using a pen.



4.1.1: General functions of menu buttons

Pressing M

- shows the current mode or the next menu item; use the M button to browse menus and settings without making any changes.
- saves a changed value.
- at the last menu item turns off the display.

Pressing + or -

- changes a value (which is only saved when M is pressed)

Accidentally changed a value but haven't confirmed it yet by pressing M? By not doing anything and waiting for 8 seconds, the display will turn itself off without changing the value.

If you are in a menu and want to change to another menu, do not press any buttons for at least 8 seconds so the display turns off, and subsequently press the button combination for the menu you want to change to.

4.2: Main menu items

The very first time the power is connected to the DVR-RGB-60, the display will show the DVR-RGB-60 type, for a couple of seconds. Next, the display shows "SET MODE". You need to set the mode of operation first, before you can move on to the other menu items.

If the power is interrupted to a DVR-RGB-60 that has already been configured, the display will only show the DVR-RGB-60 type when the power comes back on, but will not go to the Set Mode menu, as the DVR-RGB-60 configuration has been saved to memory.

Proceed as follows to configure your DVR-RGB-60:

1. Set the mode of operation (COLR, SHOW, or DMX) in the mode selection menu.
2. Set the LED group configuration in the LED menu.
3. Configure the operation mode you have chosen in step 1 (COLR, SHOW, or DMX).

Except for the configuration menus SET MODE, LED, COLR/SHOW/DMX and LED CODE, a number of other menus give the DVR-RGB-60 some additional features:

- TEST: lets you perform a test run of the connected LEDs
- LOCK: lets you softlock or hardlock the DVR-RGB-60's configuration
- RESET: lets you reset the DVR-RGB-60 to the factory default settings

4.2.1: Setting the mode of operation

In the mode selection menu, you can set the mode of operation for your driver/controller:

- COLR MODE: lets you set a colour for standalone operation.
- SHOW MODE: lets you set a show sequence for standalone operation.
- DMX MODE: lets you configure DMX related settings (start address, network resolution, termination) for networked operation.

To enter the mode selection menu:

1. The very first time the power is connected to the DVR-RGB-60, the display will show the DVR-RGB-60 type for a couple of seconds and then automatically enter the SET MODE menu.

When you want to change the mode of operation of a previously configured DVR-RGB-60, press the M button for five seconds to enter the SET MODE menu. The display shows "SET" - "MODE" followed by the name of the first mode (COLR).

2. Press + or - until the display shows the mode you want your driver/controller to operate in: COLR, SHOW, DMX.
3. Press the M button to save your selection. The display will turn off after you have pressed the M button.

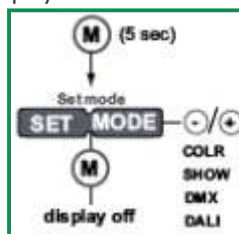

The display also turns off after 8 seconds of inactivity. To enter the Mode menu again, repeat the aforementioned sequence.

After you have confirmed COLR MODE as the mode of operation, it is recommended to set the LED groups via the SETUP menu first, before entering the COLR menu to set the colour of your choice.

For information on how to configure the LED groups, see 4.2.2 "Configuring LED groups".

4.2.2: Configuring LED groups

In the SETUP menu, you can configure the LED groups and an external input device.

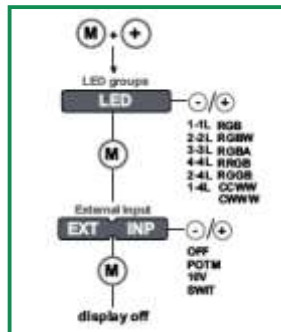

To enter the SETUP menu:

1. Press the M and + button simultaneously.
2. The display displays LED. This menu option configures the LED groups. Possible values are:
 - a. 1-1L: one DMX channel is used for one LED group (group 1). The other LED group connectors are disabled.
 - b. 2-2L: two DMX channels are used for two LED groups, the group 1 and group 2 connector. Group 3 and 4 are disabled.
 - c. 3-3:L: three DMX channels are used for LED groups 1, 2 and 3. Group 4 is disabled.
 - d. 4-4L: one DMX channel is used per LED group.
 - e. 2-4L: two DMX channels are used for four LED groups, one for group 1 and 2, the other for group 3 and 4.
 - f. 1-4L: one DMX channel is used for four LED groups.
 - g. RGB: 3 DMX channels are used for three LED groups: one channel for red LEDs, one for green LEDs and one for blue LEDs.
 - h. RGBW: four DMX channels are used for four LED groups: one channel for red LEDs, one for green LEDs, one for blue LEDs and one for white LEDs.
 - i. RGBA: four DMX channels are used for four LED groups: one channel for red LEDs, one for green LEDs, one for blue LEDs and one for amber LEDs.
 - j. RRGB: three DMX channels are used for four LED groups: two channels for red LEDs, one for green LEDs and one for blue LEDs.
 - k. RRGB: three DMX channels are used for four LED groups: one channel for red LEDs, two for green LEDs and one for blue LEDs.
 - l. CCWW: one DMX channel is used for two LED groups with the same colour and one DMX channel is used for two LED groups consisting of white LEDs only.
 - m. CWWW: one DMX channel is used for one LED group and one DMX channel is used for three LED groups consisting of white LEDs only.
3. Press M to confirm the LED group configuration of your choice.
4. The EXT INP menu item allows you to configure the DVR-RGB-60 for use with an external input device such as a 10kΩ potentiometer (POTM), a 0...10V control device (10V) or a show switch (SWIT). The first two allow you to turn on/off and dim the light, the last one to select another show sequence. Confirm your choice by pressing M.

When the EXT INP menu item is set to another value than OFF, but no device is connected to the EXT connectors, the driver/controller will not yield the optimum light output.

4.2.3: Configuring the operation mode "COLR"

In COLR mode, you can set your LED application's colour for standalone (i.e. non networked) operation. To change the COLR settings:

1. Press M to enter the COLR menu. Your options in the COLR menu depend on the way you have configured your LED groups in the SETUP menu. Below you will find the COLR menu options for the corresponding LED group configurations.

1-1L and 1-4L

1-1L: one DMX channel is used for one LED group (group 1). The other LED group connectors are disabled.

1-4L: one DMX channel is used for four LED groups. This means that all four groups have light output.

INT (intensity) lets you set the intensity of the light output: 255 is full on, 0 is off.

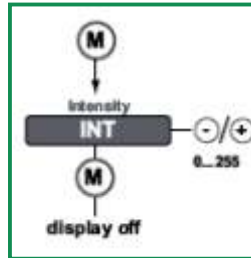

2-2L and 2-4L

2-2L: two DMX channels are used for two LED groups, the group 1 and group 2 connector. Group 3 and 4 are disabled.

2-4L: two DMX channels are used for four LED groups, one for group 1 and 2, the other for group 3 and 4.

INT (intensity) lets you set the intensity of the light output of each channel: 255 is full on, 0 is off.

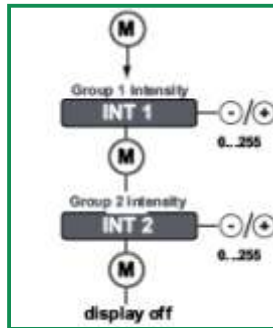

3-3L

3-3L: Three DMX channels are used for LED groups 1, 2 and 3. Group 4 is disabled. INT (intensity) lets you set the intensity of the light output of each channel: 255 is full on, 0 is off.

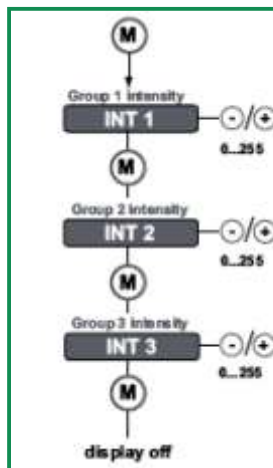

RGB / RRGB / RRGB

RGB: 3 DMX channels are used for three LED groups: one channel for red LEDs, one for green LEDs and one for blue LEDs.
RRGB: 3 DMX channels are used for four LED groups: two channels for red LEDs, one for green LEDs and one for blue LEDs.
RRGB: 3 DMX channels are used for four LED groups: one channel for red LEDs, two for green LEDs and one for blue LEDs.

HUE lets you set the colour: By pressing + or - you actually 'walk' along the sides of the colour triangle shown below, which is based on the CIE diagram. By pressing M you confirm the colour of your choice. Then, INT lets you set the brightness of the chosen colour.

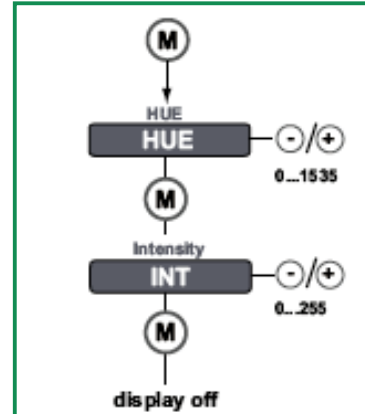
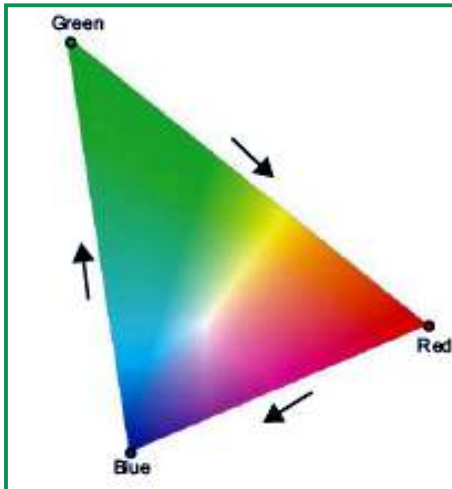

RGBW / RGBA

RGBW: 4 DMX channels are used for four LED groups: one channel for red LEDs, one for green LEDs, one for blue LEDs and one for white LEDs.
RGBA: 4 DMX channels are used for four LED groups: one channel for red LEDs, one for green LEDs, one for blue LEDs and one for amber LEDs.

HUE lets you set the colour: By pressing + or - you actually 'walk' along the sides of the colour triangle shown below, which is based on the CIE diagram. By pressing M you confirm the colour of your choice. Then, WHITE lets you add white or amber (you 'walk' towards the white center of the colour triangle). Finally, INT lets you set the intensity of the light output.

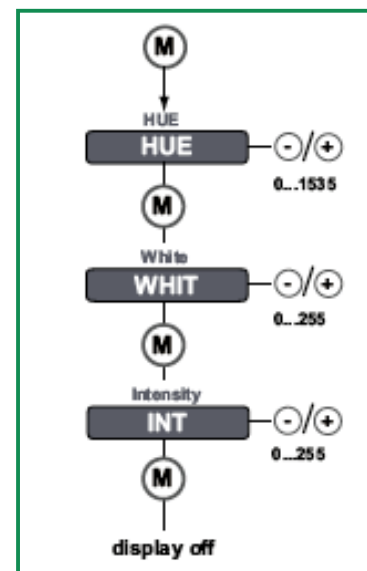
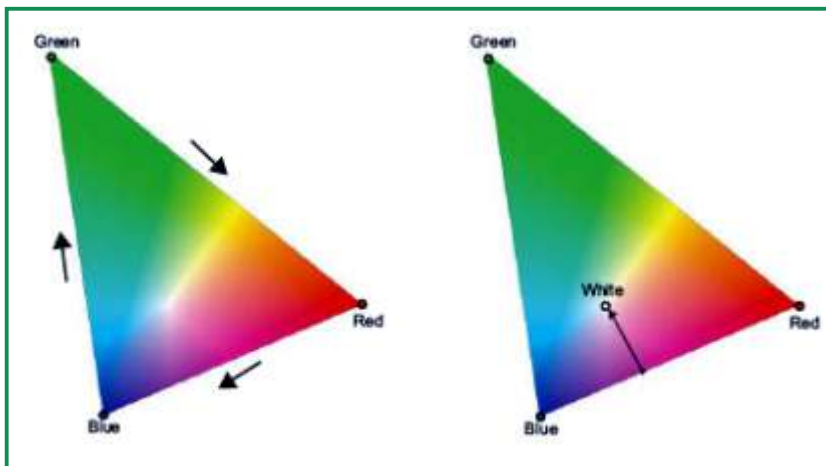

4.2.4: Configuring the operation mode "SHOW"

Your driver/controller comes with 9 default or a number of custom show sequences. Your LED application can run these show sequences

- when the LED application is not part of a network (standalone operation).
- when no DMX signal is received over the network

In SHOW mode, you can choose a show sequence and set this sequence's speed and intensity i.e. brightness.

To change the SHOW settings:

1. Press M to enter the SHOW menu.

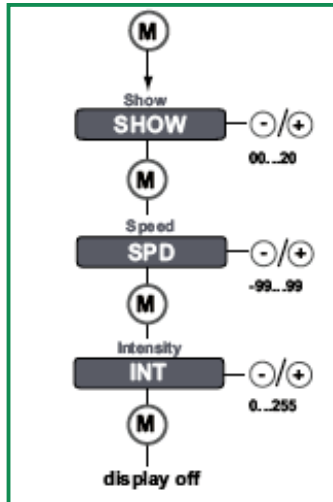

a. SHOW allows you to select a different show sequence. DVR-RGB-60 can contain up to 20 show sequences.

b. SPD (speed) allows you to change the speed of the selected show sequence. Possible range is -99 through 99, with 0 representing the show sequence's default speed, -99 twice as slow and 99 twice as fast.

c. INT (intensity) allows you to change the intensity of the selected show sequence. Possible range is 0 (off) through 255 (full on).

2. When a changed menu option is saved, the next menu option is automatically displayed on the display. When you've reached the last menu option and press M, the display turns off. The display also turns off after 8 seconds of inactivity. To enter the Show menu again after the display has turned off, repeat the aforementioned sequence.

4.2.5: Configuring the operation mode "DMX"

In DMX MODE, you can set DVR-RGB-60's network start address and its network resolution.

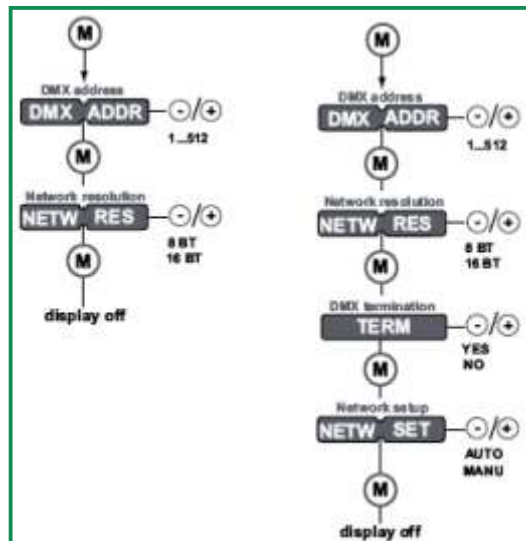

To change the DMX settings: sequences

1. Press M to enter the DMX menu.
2. Press M to browse the DMX menu options. These are DMX ADDR (DMX address), NETW RES (network resolution). When you reach the required menu option, press + or - to change its value and M to save the changed value. Pressing M after the last menu option exits the configuration and turns off the display.

a. DMX ADDR allows you to select a network start address for your driver/controller. Value range is 1 through 512.

b. NETW RES allows you to set the network resolution for your driver/controller to 8 or 16 bit. Note that 16 bit allows much smoother dimming and more accurate colour mixing.

c. TERM allows you to enable termination on your driver/controller.

d. NETW SET allows you to decide whether you want the network start address assigned automatically (AUTO), or if you want to set it manually (MANU).

4.2.6: Locking the Configuration

You can ensure that your driver/controller's settings are not changed by locking its configuration. You can choose

- not to lock the configuration: everyone with access to the driver/controller can change its settings
- soft-lock the configuration: you can only enter the SHOW, COLR or TEST menu or reset the driver/controller to its factory defaults.
- hard-lock the configuration: none of the driver/controller's settings can be changed.

To change the SHOW settings: 1. Press M to enter the SHOW menu.

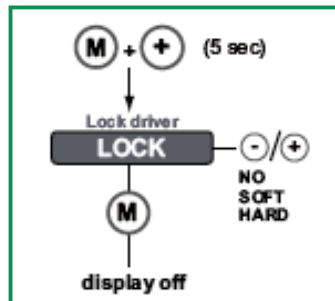

To lock the driver/controller's configuration:

1. Press M and + simultaneously for 5 seconds.
2. Press + or - until the display correctly reflects your choice:
 - a. NO (do not lock driver/controller)
 - b. SOFT (soft-lock the driver/controller)
 - c. HARD (hard-lock the driver/controller).
3. Press M to confirm your selection. The display turns itself off after you have confirmed your choice.

4.2.7: Unlocking a soft-locked driver/controller

To unlock a soft-locked driver/controller and regain full access to all menus:

1. Press M and + simultaneously for 5 seconds.
2. Press + or - until the display correctly reflects your choice:
 - a. YES (the driver/controller remains soft-locked)
 - b. NO (the driver/controller is unlocked)
3. Press M to confirm your selection. The display turns itself off after you have confirmed your choice.

4.2.8: Carrying out a test run

You can carry out an RGBW test run with fade for each channel, to check if (a) all LEDs are fully functional (b) you have correctly configured your LED groups in the SETUP menu.

To carry out the test run:

1. Press M and + simultaneously for 5 seconds.
2. The connected LED groups are lit as follows:
 - for one second, LED group 1 (R) is lit
 - for one second, LED group 2 (G) is lit
 - for one second, LED group 3 (B) is lit
 - for one second, LED group 4 (W) is lit
 - for one second, LED group 1, 2, 3 and 4 (RGBW) are lit at the same time
 - this sequence is repeated once more

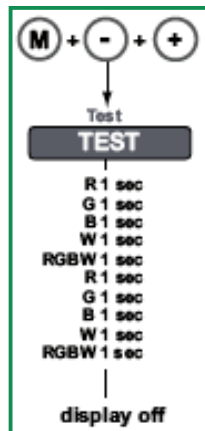

4.2.9: Resetting the driver/controller to its factory default settings

You can carry out an RGBW test run with fade for each channel, to check if (a) all LEDs are fully functional (b) you have correctly configured your LED groups in the SETUP menu.

To carry out the test run:

1. Press M and + simultaneously for 5 seconds.
2. The display shows "RE-" "SET" and "PRES MENU"
3. Press M to carry out the reset, or do not press any button for 8 seconds - this allows you to exit the menu without actually carrying out the reset.

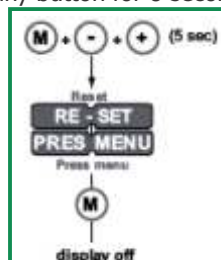

A Specifications

Electrical data

- Current:
DVR-RGB-60: up to 6A (1.5A per channel)
- Power output:
DVR-RGB-60: up to 180 watts
- Operating supply voltage range: 12V-28V DC
- Processor: eldoLED FluxLogic 850 Series
- Independent LED groups: up to 4
- Reverse polarity protection

Certifications

- CE: IEC 61347, EN 55015, IEC 61003, EN 61547

Dimensions

- LxWxH: 153 mm x 50 mm x 23 mm / 6.02" x 1.97" x 0.91"



Dynamic effects

- Hydradrive Algorithm Based Modulation
- Control of channel 1 (R), 2 (G), 3 (B) and 4 (W/A): 0 - 100% in 15-bit set point resolution
- Contrast ratio: up to 2,000:1

Environmental ratings

- Ta range: from -20°C to +50°C (from -4°F to +122°F)
- Tc max: 65°C (149°F)
- The heat sink max: 60°C (140°F)
- Relative humidity: non-condensing

Mechanical dimensions

- The illustration below shows the mechanical dimensions in mm:

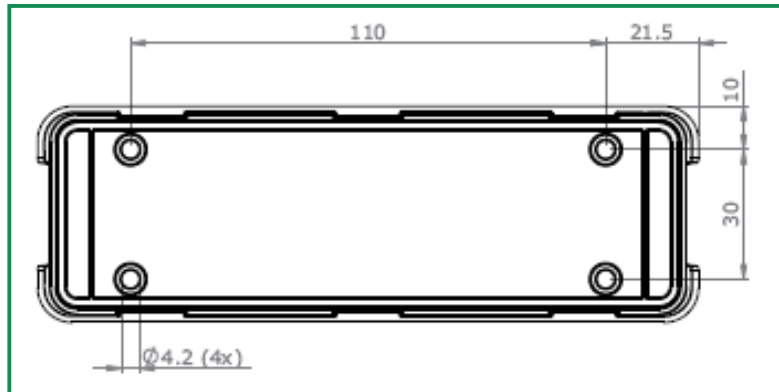

Mounting data

- Mounting orientation: any
- Mounting holes: suited for M4 screws (4)

Network control

- Network input: USITT DMX512A, LedSync
- Network output: LedSync
- Network input/output: based on RS485 specification
- DMX/LedSync-in update rate: 8ms
- Network resolution: 8 or 16 bit, configurable over menu buttons
- Network channels used by driver in 8-bit resolution: 4
- Network channels used by driver in 16-bit resolution: 8
- Communication: bidirectional for driver configuration and temperature read-out
- Configuration: via menu buttons and display or via TOOL box and freely available PC software

Spring cage connectors DVR-RGB-60

- VDC: + and - (2)
- EXT in: + and - (2) for 10kOhm potentiometer, 0-10V or show switch
- DMX in: +, - and shield (3)
- LedSync thru: +, - and shield (3)
- LED groups and LED supply: group 1 through 4 and LED ground (5)

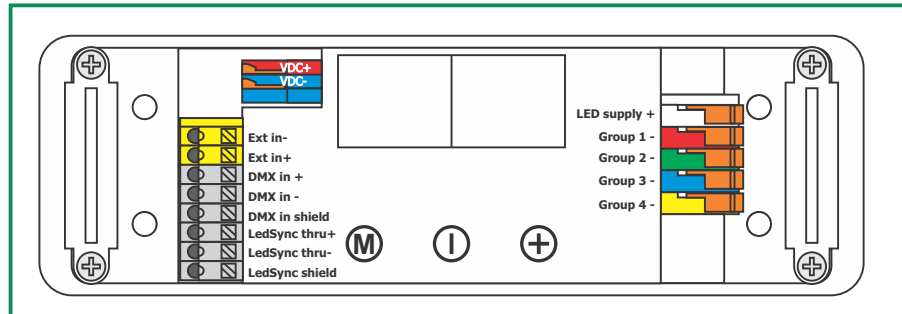

Thermal data

- Cooling: passive (integrated heat spreader).
- Built-in protection against overheating of driver/controller

User interface

- Menu buttons: M, - and + (3)
- Display: segmented (4x16)
- Modes: colour/show/DMX mode
- Features: setup, lock, reset

Wire sizes

- VDC: 0.14mm - 0.5mm (AWG 26 - 20)
- EXT in: 0.5mm- 1.5mm (AWG 20 - 16)
- DMX in: 0.5mm- 1.5mm (AWG 20 - 16)
- LedSync thru: 0.5mm- 1.5mm (AWG 20 - 16)
- LED groups: 0.14mm - 1mm (AWG 26 - 18)