

SUN3 LED UPLIGHT OR STEP LIGHT COMPONENTS - INDOOR/OUTDOOR

REV.08.10.16



SUN3-HDL_RD-WW-SA



SUN3-HDL_SQ-WW-SA



SUN3-JC



SC-WO

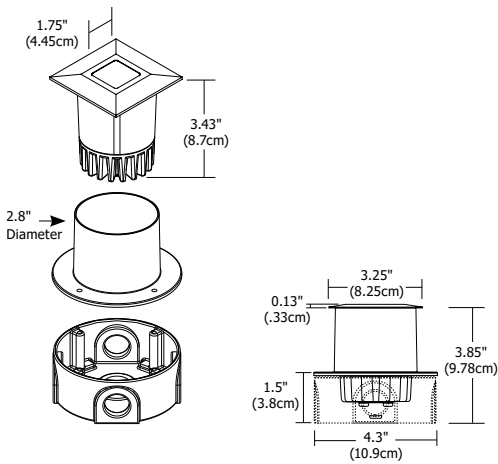

Wet Location Round Junction Box Supplied By Electrician

Indoor Octagon Junction Box Supplied By Electrician

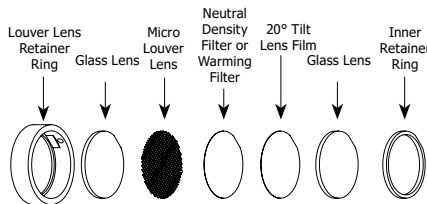

STEP LIGHT KIT SUN3-LL



Lighting Facts Label reflects test data for Sun3 with 16 degree lens (L1). See Lamp Specification section above for additional details.

Description:

The 3" recessed round or square SUN3 LED has a 6.5 watt, high powered warm white LED and features a 16, 23, 36 or 47 degree precise focus, tempered glass lens with marine-grade aluminum beveled edge trim. The fixture is rated for outdoor/ocean front environments using a wet location electrical box or indoor using a standard octagon electrical box. The trim accepts dichroic color filters which are used with SUN3-LL(H). Order junction box cover, wood spring clips and remote transformer separately. Fixture includes 5 year warranty.

Finish: Satin Aluminum **Weight:** 1.8 lb (.82 kg)

Lamp Specification:

70% lumen maintenance based on 50,000 hours of operation.
LED 6.5W Warm white, 2968K, 80 CRI

At 16 degrees, 42 lumens per watt/281 total lumens

LENS/ BEAM SPREAD	INPUT VOLTS	WATTS	CBCP	RATED LIFE	COLOR TEMP(K)	CRI
L1 = 16 Degree	12VAC	6.5	2,537	50,000	2,968	80
L2 = 23 Degree	12VAC	6.5	1,520	50,000	2,968	80
L3 = 36 Degree	12VAC	6.5	713	50,000	2,968	80
L4 = 47 Degree	12VAC	6.5	482	50,000	2,968	80

Transformer:

Electronic TE-60L-12; Magnetic T-150-12, T-300-12

Dimming:

Dimmable with electronic low voltage dimmer using TE-60L-12 (sold separately). Lutron dimmers recommended: Dims to 9% with Diva #DVELV-300P; 21% with Skylark #SELV-300P; 31% with Maestro #MAELV-600.

Dimmable with magnetic low voltage dimmer using T-150-12 (sold separately). Lutron dimmers recommended: Dims to 16% with Diva #DVLV-600P; 39% with Skylark #SLV-600P

Product	Head/Lens	Description	Color Temperature	Finish
SUN3	HDL1	RD	WW	SA
SUN3 Sun3	HDL1 16 Degree Lens HDL2 23 Degree Lens HDL3 36 Degree Lens HDL4 47 Degree Lens	RD Round SQ Square	WW Warm White	SA Satin Aluminum

Product	Description	Product	Type
SUN3	JC	SC	WO
SUN3 Sun3	JC Junction Cover LL 2" Louver with 20° Beam Tilt Lens, Neutral Density Filter, Warming Filter LLH Louver Lens Holder	SC Spring Clip	WO Wood

PROJECT:

FIXTURE TYPE:

DATE:



SUN3 LED UPLIGHT OR STEP LIGHT - INDOOR/OUTDOOR

REV.08.10.16



LENS/ BEAM SPREAD	INPUT VOLTS	WATTS	CBCP	RATED LIFE	COLOR TEMP(K)	CRI
L1 = 16 Degree	12VAC	6.5	2,537	50,000	2,968	80
L2 = 23 Degree	12VAC	6.5	1,520	50,000	2,968	80
L3 = 36 Degree	12VAC	6.5	713	50,000	2,968	80
L4 = 47 Degree	12VAC	6.5	482	50,000	2,968	80

SUN3 16 DEGREE	<p>Beam Angle 16°</p> <table border="1"> <thead> <tr> <th>D</th> <th>FC</th> <th>DIA</th> </tr> </thead> <tbody> <tr><td>2'</td><td>775</td><td>7"</td></tr> <tr><td>3'</td><td>346</td><td>10"</td></tr> <tr><td>4'</td><td>194</td><td>14"</td></tr> <tr><td>6'</td><td>86</td><td>20"</td></tr> <tr><td>8'</td><td>49</td><td>27"</td></tr> <tr><td>10'</td><td>32</td><td>34"</td></tr> </tbody> </table>	D	FC	DIA	2'	775	7"	3'	346	10"	4'	194	14"	6'	86	20"	8'	49	27"	10'	32	34"	SUN3 23 DEGREE	<p>Beam Angle 23°</p> <table border="1"> <thead> <tr> <th>D</th> <th>FC</th> <th>DIA</th> </tr> </thead> <tbody> <tr><td>2'</td><td>404</td><td>10"</td></tr> <tr><td>3'</td><td>180</td><td>15"</td></tr> <tr><td>4'</td><td>101</td><td>20"</td></tr> <tr><td>6'</td><td>45</td><td>29"</td></tr> <tr><td>8'</td><td>25</td><td>39"</td></tr> <tr><td>10'</td><td>16</td><td>49"</td></tr> </tbody> </table>	D	FC	DIA	2'	404	10"	3'	180	15"	4'	101	20"	6'	45	29"	8'	25	39"	10'	16	49"
	D	FC	DIA																																										
2'	775	7"																																											
3'	346	10"																																											
4'	194	14"																																											
6'	86	20"																																											
8'	49	27"																																											
10'	32	34"																																											
D	FC	DIA																																											
2'	404	10"																																											
3'	180	15"																																											
4'	101	20"																																											
6'	45	29"																																											
8'	25	39"																																											
10'	16	49"																																											
SUN3 36 DEGREE	<p>Beam Angle 36°</p> <table border="1"> <thead> <tr> <th>D</th> <th>FC</th> <th>DIA</th> </tr> </thead> <tbody> <tr><td>2'</td><td>184</td><td>16"</td></tr> <tr><td>3'</td><td>82</td><td>23"</td></tr> <tr><td>4'</td><td>46</td><td>31"</td></tr> <tr><td>6'</td><td>20</td><td>47"</td></tr> <tr><td>8'</td><td>12</td><td>62"</td></tr> <tr><td>10'</td><td>7</td><td>78"</td></tr> </tbody> </table>	D	FC	DIA	2'	184	16"	3'	82	23"	4'	46	31"	6'	20	47"	8'	12	62"	10'	7	78"	SUN3 47 DEGREE	<p>Beam Angle 47°</p> <table border="1"> <thead> <tr> <th>D</th> <th>FC</th> <th>DIA</th> </tr> </thead> <tbody> <tr><td>2'</td><td>96</td><td>21"</td></tr> <tr><td>3'</td><td>43</td><td>31"</td></tr> <tr><td>4'</td><td>24</td><td>42"</td></tr> <tr><td>6'</td><td>11</td><td>63"</td></tr> <tr><td>8'</td><td>6</td><td>84"</td></tr> <tr><td>10'</td><td>4</td><td>104"</td></tr> </tbody> </table>	D	FC	DIA	2'	96	21"	3'	43	31"	4'	24	42"	6'	11	63"	8'	6	84"	10'	4	104"
	D	FC	DIA																																										
2'	184	16"																																											
3'	82	23"																																											
4'	46	31"																																											
6'	20	47"																																											
8'	12	62"																																											
10'	7	78"																																											
D	FC	DIA																																											
2'	96	21"																																											
3'	43	31"																																											
4'	24	42"																																											
6'	11	63"																																											
8'	6	84"																																											
10'	4	104"																																											

Wall Mounting		Step Mounting																																														
SUN3 with LF2-20D and Micro Louver	<p>4" →</p> <p>→ LENGTH OF BEAM</p> <p>DIA</p> <p>3"</p>	<p>w/opposite wall white w/opposite wall black</p> <table border="1"> <thead> <tr> <th>LENGTH</th> <th>FC</th> <th>FC</th> <th>WIDTH</th> </tr> </thead> <tbody> <tr><td>3"</td><td>370</td><td>369</td><td>2"</td></tr> <tr><td>12"</td><td>194</td><td>192</td><td>3.5"</td></tr> <tr><td>21"</td><td>12</td><td>12</td><td>7"</td></tr> <tr><td>30"</td><td>3</td><td>2.6</td><td>13"</td></tr> <tr><td>39"</td><td>2</td><td>0.9</td><td>14"</td></tr> <tr><td>48"</td><td>5.7</td><td>0.7</td><td>18.5"</td></tr> </tbody> </table> <p>SUN3-HDL1 with LF2-20D and Micro Louver</p>	LENGTH	FC	FC	WIDTH	3"	370	369	2"	12"	194	192	3.5"	21"	12	12	7"	30"	3	2.6	13"	39"	2	0.9	14"	48"	5.7	0.7	18.5"	SUN3 with LF2-20D, LF2-LS and Micro Louver	<p>4"</p> <p>→ WIDTH OF BEAM</p> <p>W</p>	<table border="1"> <thead> <tr> <th>LENGTH</th> <th>FC</th> <th>WIDTH</th> </tr> </thead> <tbody> <tr><td>3"</td><td>159</td><td>8"</td></tr> <tr><td>6"</td><td>182</td><td>11.5"</td></tr> <tr><td>9"</td><td>116</td><td>11.5"</td></tr> <tr><td>12"</td><td>49</td><td>12.3"</td></tr> </tbody> </table> <p>SUN3-HDL1 with LF2-20D, LF2-LS and Micro Louver</p>	LENGTH	FC	WIDTH	3"	159	8"	6"	182	11.5"	9"	116	11.5"	12"	49	12.3"
	LENGTH	FC	FC	WIDTH																																												
3"	370	369	2"																																													
12"	194	192	3.5"																																													
21"	12	12	7"																																													
30"	3	2.6	13"																																													
39"	2	0.9	14"																																													
48"	5.7	0.7	18.5"																																													
LENGTH	FC	WIDTH																																														
3"	159	8"																																														
6"	182	11.5"																																														
9"	116	11.5"																																														
12"	49	12.3"																																														

PROJECT:

FIXTURE
TYPE:

DATE:



REV.08.10.16



Junction Cover

Use indoor with standard octagon electrical box or use outdoor with wet location electrical box.

Product	Description
SUN3	JC
SUN3 Sun3	JC Junction Cover

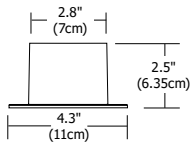

Spring Clip

Use the Spring Clip to recess Sun3 into outdoor wood steps, decks, etc. without junction box.

Product	Type
SC	WO
SC Spring Clip	WO Wood

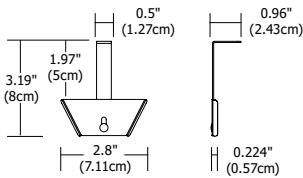

PROJECT:

FIXTURE TYPE:

DATE:



OPTICAL ACCESSORIES FOR SUN3 LOUVER LENS HOLDER

REV.08.10.16



Sun3 Louver Lens Holder

Louver Lens Holders secure onto front of the lamp holding up two lenses or combination of a hexcell louver and lens. Required for securing louvers, lenses and filters in the Sun3.

ACCESSORY		TYPE
SUN3	-	LLH
SUN3 MR16		LLH Louver Lens Holder



Hexcell Louver



Micro Louver

Hexcell and Micro Louver

The Hexcell Louver eliminates glare from the light beam. The Micro Louver used in step lighting requires both the louver lens holder #SUN3-LLH and the 20 degree filter #LF2-20D.

ACCESSORY		TYPE
LO16	-	H
LO16 MR16		H Hexcell Louver M Micro Louver

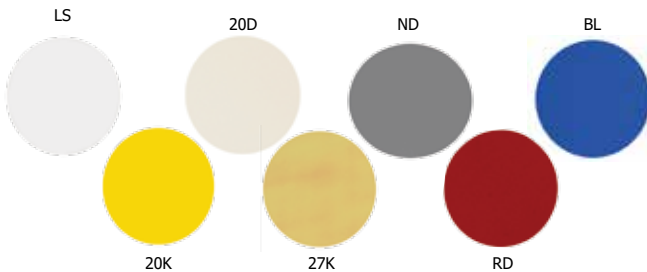

Film Lenses and Filters

Add film lenses and filters to shape beam, change color or adjust color temperatures. Louver lens holder #SUN3-LLH required.

LENS FILM		LENS OR COLOR
LF2	-	20D
LF2 Lens Film 2" diameter		20D Refracts beam 20° down 20K Dichroic 2000K Very Warm White 27K Dichroic 2000K + Color Correction Film = 2700K ND Neutral Density Filter dims light 50% RD Red Dichroic Film BL Blue Dichroic Film LS Linear Spread

PROJECT:

FIXTURE
TYPE:

DATE:



REV.08.10.16

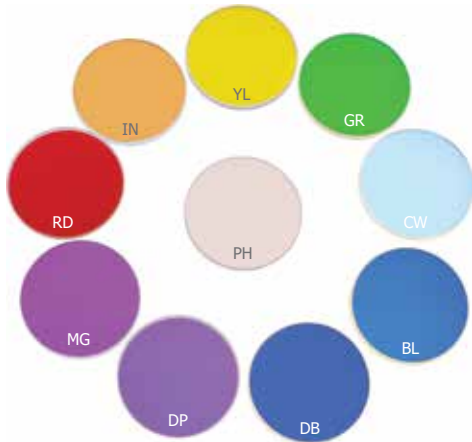

Dichroic Glass Lens

Dichroic lenses operate on a passive-reflective basis, reflecting unused wavelengths while passing wanted portions of spectrum. Dichroics are high in transmission, producing brighter, cleaner, saturated colors. Louver lens holder #SUN3-LLH not required.

ACCESSORY LENS	DICHROIC COLOR										
L16	RD										
L16 MR16	<table border="0"> <tr> <td>RD Red</td> <td>MG Magenta</td> </tr> <tr> <td>YL Yellow</td> <td>CW Cool White (3100K-4250K)</td> </tr> <tr> <td>GR Green</td> <td>DB Dark Blue</td> </tr> <tr> <td>BL Blue</td> <td>DP Dark Pink</td> </tr> <tr> <td>PH Peach</td> <td>IN Incandescent (3100-2700K)</td> </tr> </table>	RD Red	MG Magenta	YL Yellow	CW Cool White (3100K-4250K)	GR Green	DB Dark Blue	BL Blue	DP Dark Pink	PH Peach	IN Incandescent (3100-2700K)
RD Red	MG Magenta										
YL Yellow	CW Cool White (3100K-4250K)										
GR Green	DB Dark Blue										
BL Blue	DP Dark Pink										
PH Peach	IN Incandescent (3100-2700K)										

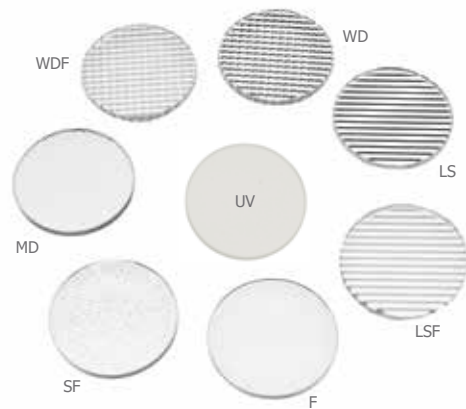

Optical Lens

The soft focus lens reduces lamp glare, spread lenses elongate and diffuser lenses diffuse the light beam. UV filter lens allows quality light to pass through while blocking the ultra violet radiation. Louver lens holder #SUN3-LLH not required.

ACCESSORY LENS	OPTICAL TYPE								
L16	F								
L16 MR16	<table border="0"> <tr> <td>F Frost</td> </tr> <tr> <td>SF Soft Focus</td> </tr> <tr> <td>MD Medium Diffuser</td> </tr> <tr> <td>WD Wide Diffuser</td> </tr> <tr> <td>WDF Wide Diffuser Frost</td> </tr> <tr> <td>LS Linear Spread</td> </tr> <tr> <td>LSF Linear Spread Frost</td> </tr> <tr> <td>UV UV Glass</td> </tr> </table>	F Frost	SF Soft Focus	MD Medium Diffuser	WD Wide Diffuser	WDF Wide Diffuser Frost	LS Linear Spread	LSF Linear Spread Frost	UV UV Glass
F Frost									
SF Soft Focus									
MD Medium Diffuser									
WD Wide Diffuser									
WDF Wide Diffuser Frost									
LS Linear Spread									
LSF Linear Spread Frost									
UV UV Glass									

PROJECT:

FIXTURE TYPE:

DATE:





Low Voltage Feed Wire Size Chart

Use to decide the correct copper wire size for a recommended 3 percent voltage drop. The length shown is the length of wire from the transformer to the power feed canopy/J-Box.

12 VOLT	5 ft.	6-15 ft.	16-20 ft.	21-40 ft.
150 watt	#12 GA	#10 GA	#8 GA	#6 GA
300 watt	#10 GA	#8 GA	#6 GA	#4 GA

Description:

The 150 or 300 watt 12 volt magnetic remote mount transformers convert line voltage into 12 volt power and are protected by fast-acting circuit breakers. All 12 volt remote magnetic transformers are LED compatible with 12 volt AC LEDs.

Power Input:

T-150-12	120 volt AC 1.25 Amp	T-300-12	120 volt AC 2.5 Amp
	230 volt AC 0.65 Amp		230 volt AC 1.3 Amp
	277 volt AC 0.54 Amp		277 volt AC 1.1 Amp

Power Output:

T-150-12	12 volt AC 150 watt 12.5 Amp
T-300-12	12 volt AC 300 watt 25 Amp

Installation:

Remote magnetic transformers must be installed in an accessible location, such as an attic or in a closet, up to 20 feet from the power feed canopy. Outdoor version available.

Dimming:

Dims with Lutron Skylark or Diva magnetic low voltage dimmer

Compatible magnetic dimmers are connected on the line voltage side of transformers. Some buzzing may occur at low levels and may be reduced with a de-buzzing coil. Visit www.edgelighting.com for up-to-date LED dimming information.

Dimensions:

8.75"(L) x 4.4"(D) x 3.8"(H)
(22.2cm x 11.2cm x 9.7cm)

Weight:

8.41 lb (3.81 kg)

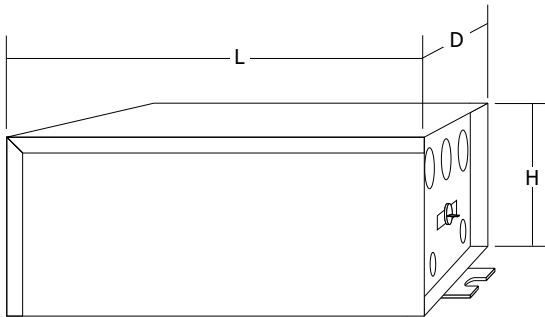

Product	Power	Voltage Output	Voltage Input	Type
T	150	12	Standard 120V (leave blank)	Standard Indoor (leave blank)
T Remote Transformer	150 150 Watt 300 300 Watt	12 12 Volt	2 230V 50Hz 3 277V 60Hz	o Outdoor

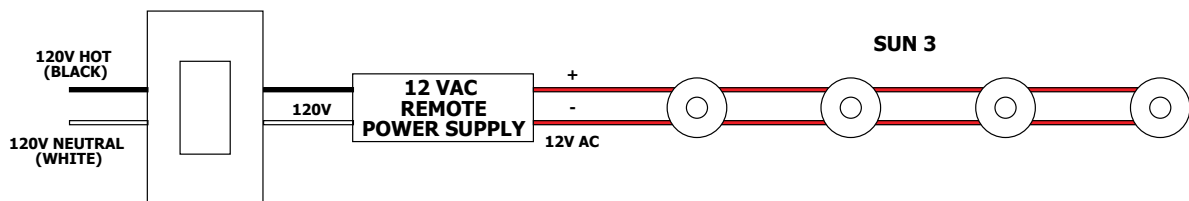

PROJECT:

FIXTURE
TYPE:

DATE:

EDGE
LIGHTING

REV.08.10.16

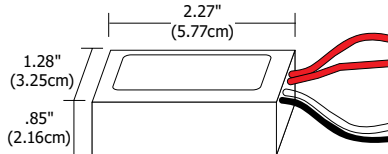

Description:

The compact, lightweight remote electronic 60W/12V LED power supply converts standard 120 volt line voltage to 12 volts and features built-in short-circuit protection. In the event of a short or overload, reset transformer at wall switch once short or overload is corrected. The single-feed transformer is both 12 volt AC LED and halogen compatible; it fits inside a 4" electrical box behind a power feed canopy.

Dimming:

Dims with Lutron Skylark or Diva electronic low voltage dimmer

Mounting Requirements:

Must be in accessible location or inside an electrical box

Weight:

.8 lb (.36 kg)

Product	Type	Voltage
TE	60L	12
TE Transformer Electronic	60L 60 Watt LED and halogen	12 12 Volt, AC

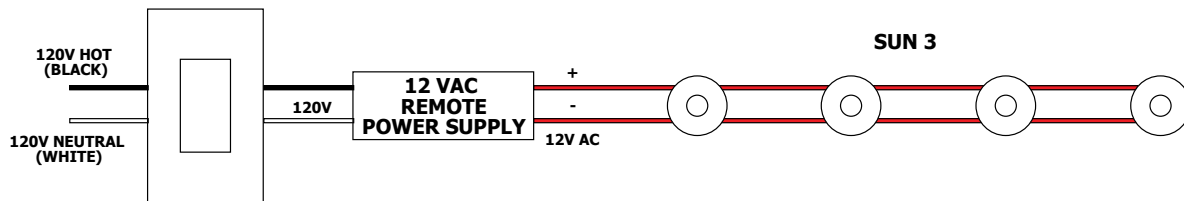

PROJECT: _____ FIXTURE TYPE: _____ DATE: _____

