

JUNO

Project: _____

Fixture Type: _____

Location: _____

Contact/Phone: _____

6" IC 600 LUMEN LED DOWNLIGHT NEW CONSTRUCTION

IC22LEDG4 RECESSED HOUSING



OPEN TRIMS



PRODUCT DESCRIPTION

Dedicated LED, Air-Loc® sealed new construction housing with integral light engine • Shallow housing allows for fit in 2 x 6 construction • Can be completely covered with insulation • Fully sealed housing stops infiltration and exfiltration of air, reducing heating and air cooling costs without the use of additional gaskets • LED housing is designed to provide 50,000 hours of life and is compatible with many standard Juno trims • 5 year limited warranty on LED components.

ENVIRONMENTALLY FRIENDLY, ENERGY EFFICIENT

- No harmful ultraviolet or infrared wavelengths
- No lead or mercury
- Comparable light output to 65W BR30 incandescent

PRODUCT SPECIFICATIONS

LED Light Engine LED array integrated to thermally conductive housing provides uninterrupted heat transfer to ensure long life of the LED • Replaceable light engine mounts directly to housing and incorporates the latest generation, high lumen output LED array • LEDs are binned within a 3-step MacAdam Ellipse exceeding ENERGY STAR® requirements for superior fixture to fixture color uniformity • 2700K, 3000K, 3500K or 4100K color temperature available • 90 CRI minimum.

Optical System Computer-optimized reflector design with high reflectance white finish coupled with a high transmission diffusing lens conceals the LEDs and produces uniform aperture luminance • Deep regression of lens produces a low glare, efficient system that can produce over 600 lumens with select trims (see page 2 for details) using less than 12W* • Wide flood distribution shipped as standard with optional optic accessories available and sold separately.

Aesthetic Trim Selections Compatible with wide selection of existing Juno trims • Shadow free, knife edge design blends seamlessly into ceiling.

LED Driver Choice of dedicated 120 volt driver or universal voltage driver that accommodates input voltages from 120-277 volts AC at 50/60Hz • Power factor > 0.9 at 120V input • 120 volt only dimmable with the use of most incandescent, magnetic low voltage and electronic low voltage wall box dimmers • Universal voltage driver is dimmable with the use of most 0-10V wall dimmers • For a list of compatible dimmers, see [JUNOICLED-DIM](#) • Mounted between the j-box and housing for easy access and cool operation.

Life Rated for 50,000 hours at 70% lumen maintenance.

Labels ENERGY STAR® Qualified when used with select baffle and cone trims • Certified to the high efficacy requirements of California T24 with select trims • UL listed for U.S. and Canada through-branch wiring, damp locations • Union made • UL and cUL.

Testing All reports are based on published industry procedures; field performance may differ from laboratory performance.

Product specifications subject to change without notice.

HOUSING FEATURES

Housing Designed for use in IC (insulated ceiling) or non-IC construction • Aluminum housing sealed for Air-Loc® compliance • Housing is vertically adjustable to accommodate up to a 2" ceiling thickness.

Junction Box Pre-wired junction box provided with (5) ½" and (1) ¾" knockouts, (4) knockouts for 12/2 or 14/2 NM cable and ground wire • UL listed and cUL listed for through-branch wiring, maximum 8 #12 branch circuit conductors • Junction box provided with removable access plates • Knockouts equipped with pryout slots • Quick connect electrical connectors supplied as standard for fast, secure installation.

Mounting Frame 22-gauge die-formed galvanized steel mounting frame • Rough-in section (junction box, mounting frame, housing and bar hangers) fully assembled for ease of installation.

Real Nail 3 Bar Hangers Telescoping Real Nail® 3 system permits quick placement of housing anywhere within 24" O.C. joists or suspended ceilings • Includes removable nail for repositioning of fixture in wood joist construction • Integral T-bar notch and clip for suspended ceilings • Design covered under US Patent D552,969.

* Nominal input wattage @ 120-volt operation with dedicated 120-volt driver under stable operating conditions.

DIMENSIONS

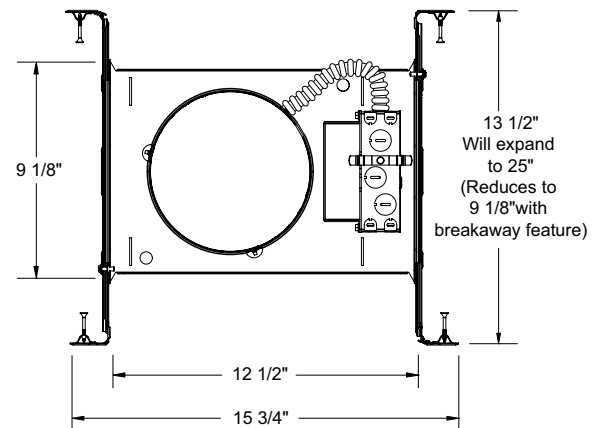
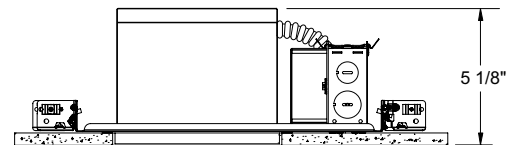

6 7/8" CEILING CUTOUT

ELECTRICAL DATA

Dedicated 120V Only Driver Option 120V

Input Power	11.7W (+/-5%)
Input Current	0.10A
Frequency	50/60Hz
EMI/RFI	FCC Title 47 CFR, Part 15, Class B (residential)
Minimum starting temp	-25°C

ELECTRICAL DATA

Universal Voltage

	120V	277V
Input Power	12.5W (+/-5%)	12.6W (+/-5%)
Input Current	0.11A	0.05A
Frequency	50/60Hz	50/60Hz
EMI/RFI	FCC Title 47 CFR, Part 15, Class A (commercial)	FCC Title 47 CFR, Part 15, Class A (commercial)
Minimum starting temp	-40°C	-40°C

6" IC 600 LUMEN LED DOWNLIGHT NEW CONSTRUCTION

















IC22LEDG4 RECESSED HOUSING
OPEN TRIMS

ORDERING INFORMATION: Housing, trim and accessories each ordered separately.

Example: **IC22LEDG4-3K-1**

Housing	Color Temperature	Input Voltage
IC22LEDG4	27K 2700K 3K 3000K 35K 3500K 41K 4100K	1 Dedicated 120V Only (Forward Phase + ELV dimmable) U Universal Voltage, 120-277V (0-10V dimmable)

Example: **24W-WH**

Trim/Description	
	24W-WH Conical White Baffle
	24B-WH^{1,2} Conical Black Baffle
	24B-SC^{1,2} Conical Black Baffle
	24B-ABZ^{1,2} Conical Black Baffle
	24B-BL^{1,2} Conical Black Baffle
	27C-WH Conical Cone in Clear Alzak®
	27G-WH Conical Cone in Gold Alzak®
	27B-WH^{1,2} Conical Cone in Black Alzak®
	27PT-SC Conical Cone in Pewter Alzak®
	27W-WH Conical Cone in Gloss White
	27HZ-WH Conical Cone in Haze
	27WHZ-WH Conical Cone in Wheat Haze
	27WHZ-ABZ Conical Cone in Wheat Haze
	9024W-WH White Octagonal w/ White Baffle
	9324-SC Luminous Disc (Frosted)
	9524-SC Chrome Band
	9702 Luminous Collar (Frosted)

ACCESSORIES

Catalog No.	Description
LEDOPTICG3-M	Medium Flood Optic (50°)
LEDOPTICG3-N	Narrow Flood Optic (37°)
LEDOPTICG3-S	Spot Optic (10°)

To order, specify catalog number.

Trim Size: 24, 27, 9324, 9524 - 7⁵/₈" O.D.; 9702 - 7³/₄" O.D.; 9024 - 8" O.D.
Trim Finish: ABZ - Classic Aged Bronze, BL - Black, SC - Satin Chrome, WH - White.
Alzak is a registered trademark of Alcoa Corp.
Note: In Canada when insulation is present, Type IC fixtures must be used.

¹ Not ENERGY STAR® Qualified
² 120V and Universal Voltage: T24 @ 3K, 35K, 41K only

PHOTOMETRIC REPORT

Test Report #: PTO2141401
Catalog No: IC22LEDG4-35K
with 24W-WH Trim
and standard wide flood optic

Luminaire Spacing Criterion: 1.16
Luminaire LPW: 62

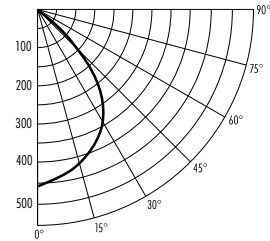

CANDLEPOWER DISTRIBUTION (Candelas)

Degrees Vertical	0°
0	455
5	451
15	424
25	378
35	297
45	134
55	59
65	29
75	17
85	4
90	0

Multiplier: 27K - 0.89
3K - 0.94
41K - 1.03

AVERAGE INITIAL FOOTCANDLES

Multiple Units (Square Array, 60'x60' room)
Ceiling 80% Wall 50% Floor 20%

Spacing	RCR1	RCR3	RCR5
4.0'	49	41	34
5.0'	32	26	22
6.0'	22	18	15
7.0'	18	15	12
8.0'	14	12	10
9.0'	11	9	7
10.0'	8	7	5

ZONAL LUMEN SUMMARY

Zone	Lumens	%Lamp	%Fixture
0-30°	336	N/A	46.0
0-40°	517	N/A	70.8
0-60°	679	N/A	92.9
0-90°	731	N/A	100.0

INITIAL FOOTCANDLES (One Unit, 11.8W, 78.8° Beam)

Distance to Illuminated Plane (Feet)	Footcandles Beam Center	Beam Diameter
4	28.4	6.6'
6	12.6	9.9'
8	7.1	13.1'
10	4.5	16.4'

LUMINANCE (Average cd/m²)

Degrees	Average Luminance
45	10410
55	5634
65	3758
75	3756
85	2451

PHOTOMETRIC REPORT

Test Report #: LTL25975R
Catalog No: IC22LEDG4-35K
with 27C-WH Trim
and standard wide flood optic

Luminaire Spacing Criterion: 0.78
Luminaire LPW: 68

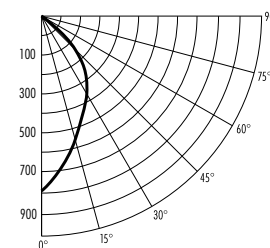

CANDLEPOWER DISTRIBUTION (Candelas)

Degrees Vertical	0°
0	797
5	749
15	569
25	446
35	318
45	152
55	48
65	10
75	0
85	0
90	0

Multiplier: 27K - 0.89
3K - 0.94
41K - 1.03

AVERAGE INITIAL FOOTCANDLES

Multiple Units (Square Array, 60'x60' room)
Ceiling 80% Wall 50% Floor 20%

Spacing	RCR1	RCR3	RCR5
4.0'	55	46	40
5.0'	35	30	25
6.0'	25	21	18
7.0'	20	17	14
8.0'	16	13	11
9.0'	12	10	9
10.0'	9	7	6

ZONAL LUMEN SUMMARY

Zone	Lumens	%Lamp	%Fixture
0-30°	433	N/A	53.9
0-40°	629	N/A	78.3
0-60°	793	N/A	98.7
0-90°	803	N/A	100.0

INITIAL FOOTCANDLES (One Unit, 11.8W, 58.1° Beam)

Distance to Illuminated Plane (Feet)	Footcandles Beam Center	Beam Diameter
4	49.8	4.4'
6	22.2	6.7'
8	12.5	8.9'
10	8.0	11.1'

LUMINANCE (Average cd/m²)

Degrees	Average Luminance
45	12833
55	5012
65	1389
75	0
85	0

Fixtures tested to IES recommended standard for solid state lighting per LM-79-08. Photometric performance on a single unit represents a baseline of performance for the fixture. Results may vary in the field.



1300 S. Wolf Road • Des Plaines, IL 60018 • Phone (847) 827-9880 • Fax (847) 827-2925
220 Chrysler Drive • Brampton, Ontario • Canada L6S 6B6 • Phone (905) 792-7335 • Fax (905) 792-0064
Visit us at www.junolightinggroup.com
Printed in U.S.A. ©2016 Acuity Brands Lighting, Inc.