



TRAC-LITES

One Circuit Trac System

TRAC SECTIONS, JOINERS & FEEDS

R2, R4, R6, and R8

Project: _____

Fixture Type: _____

Location: _____

Contact/Phone: _____

PRODUCT DESCRIPTION

Reduced-profile, single-circuit trac sections for surface or pendant mounting. Compatible with a full range of feed, connector and mounting accessories, as listed on back of this page. Accepts all Trac-Lites and Trac-Master trac fixtures.

PRODUCT SPECIFICATIONS

Construction Extruded aluminum with thermoplastic insulator

- Injection molded polycarbonate dead-end with set screw
- Standard lengths may be cut-to-length by installer.

Electrical Two 12 gauge solid copper conductors • Rated 20 amps at 120 volts • Aluminum channel used as system ground • One-piece insulator insures consistent conductor spacing for reliable electrical contact • Insulating bushings supplied at mounting hole locations to prevent shorts to ground.

Labels UL/CUL listed.

PRODUCT INSTALLATION

Debossed polarity line provides visual cue to proper trac, trac connector and fixture alignment • Supplied with toggle bolts for surface mounting • Insulator stays same length as extrusion to simplify field-cutting of trac • Connectors and feeds simply push into trac sections.

Product specifications subject to change without notice.

DIMENSIONS

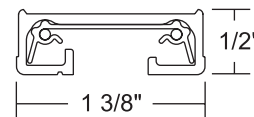
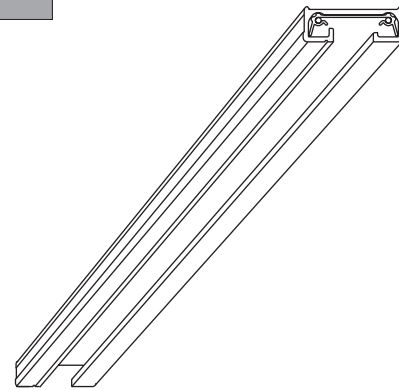
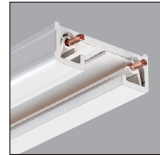

PRODUCT CODES

Catalog Number	Description	Actual Length	Finish
R2WH	2' Trac Section	19 7/8"	White
R2BL	2' Trac Section	19 7/8"	Black
R2SL	2' Trac Section	19 7/8"	Silver
R2NA	2' Trac Section	19 7/8"	Natural
R2BZ	2' Trac Section	19 7/8"	Bronze
R4WH	4' Trac Section	43 7/8"	White
R4BL	4' Trac Section	43 7/8"	Black
R4SL	4' Trac Section	43 7/8"	Silver
R4NA	4' Trac Section	43 7/8"	Natural
R4BZ	4' Trac Section	43 7/8"	Bronze
R6WH	6' Trac Section	67 7/8"	White
R6BL	6' Trac Section	67 7/8"	Black
R6SL	6' Trac Section	67 7/8"	Silver
R6NA	6' Trac Section	67 7/8"	Natural
R6BZ	6' Trac Section	67 7/8"	Bronze
R8WH	8' Trac Section	91 7/8"	White
R8BL	8' Trac Section	91 7/8"	Black
R8SL	8' Trac Section	91 7/8"	Silver
R8NA	8' Trac Section	91 7/8"	Natural
R8BZ	8' Trac Section	91 7/8"	Bronze

TRAC-LITES

One Circuit Trac System

TRAC SECTIONS, JOINERS & FEEDS

R2, R4, R6, and R8

Electrical End Feeds

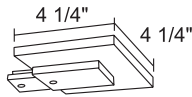

R21WH, R21BL, R21SL, R21BZ
End Feed Connector and Outlet Box Cover. For outlet box feed. Includes: outlet box cover, fixture strap and ground screw.

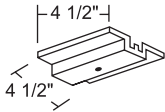

R21RWH, R21RBL, R21RSL
Same as above except designed for use in opposite polarity orientation compared to standard feed connectors.

R29WH, R29BL, R29SL, R29BZ
Floating Electrical Feed. Permits mounting any point of trac under outlet box. Includes floating connector, outlet box cover plus extra trac dead end.

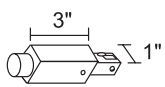

R34WH, R34BL, R34SL, R34BZ
Conduit Feed. For surface wiring. Use standard 1/2" connector.

R34RWH, R34RBL, R34RSL
Same as above except designed for use in opposite polarity orientation compared to standard feed connectors.

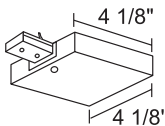

R36WH, R36BL, R36SL, R36BZ
T-Bar End Feed. Wiring compartment contains standard 1/2" KO's. Feeds surface trac from above, when T-bar is directly above trac.

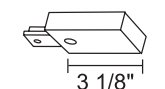

R36RWH, R36RBL, R36RSL
Same as above except designed for use in opposite polarity orientation compared to standard feed connectors.

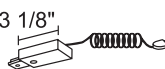

R38WH, R38BL, R38SL, R38BZ
Live End Feed Connector. Feed trac from above with flexible conduit, BX, etc., or end feed in pendant systems. Accepts standard 1/2" connector.

R38RWH, R38RBL, R38RSL
Same as above except designed for use in opposite polarity orientation compared to standard feed connectors.



R22WH, R22BL, R22SL, R22BZ
Cord and Plug Connector. Comes with 15' two-wire white cord. Includes surface wire retainers and in-line switch. Max cap. 7 amps. Not UL Listed.

R122WH, R122BL, R122SL, R122BZ
Same as above but with matching color 3-wire grounded cord and plug. No switch. Not UL Listed.

Trac Joiners



R20WH, R20BL, R20SL, R20BZ
Accordion Adjustable Joiner. Can flex to 90° angle to left, right, up or down. Joins two trac sections.

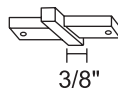

R23WH, R23BL, R23SL, R23BZ
Miniature Straight Connector. Joins two trac sections end to end.

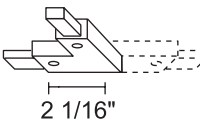

‡ **R24WH, R24BL, R24SL, R24BZ**
Adjustable Connector. Joins two trac sections to make a 90° angle or straight run. Straight and right angle covers supplied. For outlet box feed, No. T27 cover plate required.

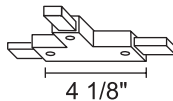

‡ **R25WH, R25BL, R25SL, R25BZ**
"T" Connector. Joins three trac sections. For outlet box feed, No. T27 cover plate required.

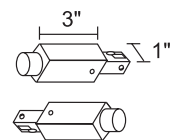

R25RWH, R25RBL, R25RSL
Same as above except designed for use in opposite polarity orientation compared to standard feed connectors.

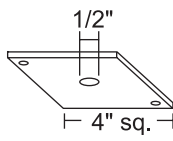

T27WH, T27BL, T27SL, T27BZ
Outlet Box Cover. Use with Nos. R24/R25 for outlet box electrical feed. Includes: nipple, locknut and ground screw.

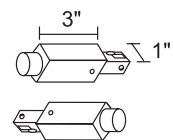

R49WH, R49BL, R49SL, R49BZ
Trac Continuation Kit. Permits trac to continue a run around obstructions. Includes one left and one right R34 Conduit Feed. Fits standard 1/2" conduit.



R28WH, R28BL, R28SL, R28BZ
Trac Dead End. For use with field-cut trac sections

‡ R24 and R25 may not be used as feed connectors in Canada due to special grounding requirements.

Product specifications subject to change without notice.

Pendant Stems

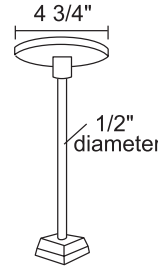

T90-12, T90-18, T90-24, T90-36, T90-48
T-Bar Pendant Stem Kit (12", 18", 24", 36", 48") - Use two for 2', 4', 6' of trac or three for 8' of trac. For electrical feed, order T93 wireway cover. WH, BL, SL, BZ

T91-12, T91-18, T91-24, T91-36, T91-48
Rigid Ceiling Pendant Stem Kit (12", 18", 24", 36", 48") - Use two for 2', 4', 6' of trac or three for 8' of trac. For electrical feed, order T93 wireway cover. WH, BL, SL, BZ

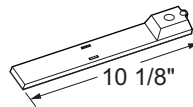

T93WH, T93BL, T93SL, T93BZ
Wireway Cover for Pendant Stem Kits T90 and T91. Conceals electrical feed wires from stem to connector. One cover required for each trac feed.



T94WH, T94BL, T94SL, T94BZ
Sloped Ceiling Adapter. Allows T90 or T91 pendant to hang straight down from sloped ceilings. Can be used to feed electrical wires to Trac at up to 60° angle.



T96WH, T96BL, T96SL, T96BZ
Pendant Stem Threaded Coupling. Enables multiple pendant stems to be joined for higher ceiling applications.



T56WH, T56BL, T56SL, T56BZ
Solid Rod Pendant Mounting Kit. Attaches solid 5/16" threaded rod to Trac. Includes: plastic cap, mounting bracket and hardware. Rod not supplied.

TRAC-LITES

One Circuit Trac System

TRAC SECTIONS, JOINERS & FEEDS

R2, R4, R6, and R8

Cable Suspension

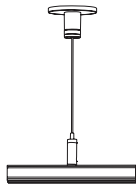

T595-48-WH, T595-48-BL
T595-144-WH, T595-144-BL

T-Bar Ceiling Cable Suspension Kit
Mechanical-only cable suspension kit for 1-circuit or 2-circuit trac. Adjustable 48" or 144" stainless steel cable length. Includes mini-canopy, T-bar clip and cable hardware. Trac requires support every 4'.

T597-48-WH, T597-48-BL
T597-144-WH, T597-144-BL

Rigid Ceiling Cable Suspension Kit
Mechanical-only cable suspension kit for 1-circuit or 2-circuit trac. Adjustable 48" or 144" stainless steel cable length. Includes mini-canopy, toggle bolt and cable hardware. Trac requires support every 4'.

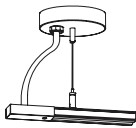

T596-48-WH, T596-48-BL
T596-144-WH, T596-144-BL

T-Bar Ceiling Cable Suspension/Feed Kit
Cable suspension kit with 48" or 144" electrical feed cable for 1-circuit trac. Includes canopy, T-bar clip, mounting plate, cable hardware and flexible electrical feed cable. Trac feed connector not included (order separately). Trac requires support every 4'.

T598-48-WH, T598-48-BL
T598-144-WH, T598-144-BL

Rigid Ceiling Cable Suspension/Feed Kit
Cable suspension kit with 48" or 144" electrical feed cable for 1-circuit trac. Includes canopy, H-box mounting strap, cable hardware and flexible electrical feed cable. Trac feed connector not included (order separately). Trac requires support every 4'.

Note: Cable suspension is recommended for pattern installations only, or those installations that are supplemented with additional rigid mounting points (stems, threaded rod, etc.).

Accessories



R37F
15/16" T-bar Attachment Clip.
To attach to inverted tee ceilings using flush tiles. Use two for 2' or 4' trac and three for 6' or 8' trac.

R37D
Same as above with spacer for ceilings using drop tiles.

R37-9-16
9/16" T-bar Attachment Clip.
To attach Trac-Lites trac to inverted tee ceilings using flush or drop tiles. Use two for 2' or 4' trac and three for 6' or 8' trac.



T31WH, T31BL, T31SL
Pendant Adapter. Adapts swag or chain-hung fixture to trac. Supports up to 25 lbs. Not UL Listed.

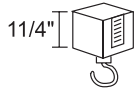

T32WH, T32BL, T32SL
Plant or Utility Hook. Supports up to 25 lbs. Not UL Listed.



T33WH, T33BL, T33SL
Outlet Adapter. Provides electrical receptacle. Not UL Listed.

Product specifications subject to change without notice.

TRAC-LITES

One Circuit Trac System

TRAC SECTIONS, JOINERS & FEEDS

R2, R4, R6, and R8

Possible Trac Configuration & Recommended Components

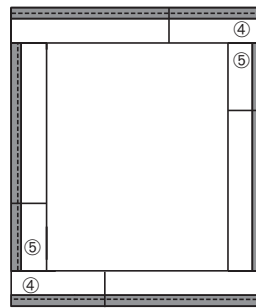
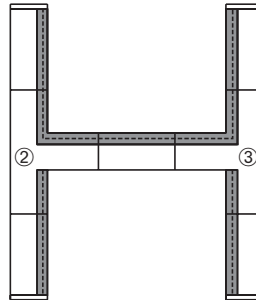
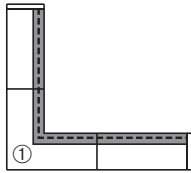

- ① Standard "L" Connector – **R24**
- ② Standard "T" Connector – **R25**
- ③ Reverse Polarity "T" Connector – **R25R**
- ④ Standard **R38** End Feed Connector
- ⑤ Reverse **R38R** End Feed Connector