



6" ECONOMY UNIVERSAL IC HOUSING

INCANDESCENT LAMPS

IC22

Project: _____

Fixture Type: _____

Location: _____

Contact/Phone: _____

PRODUCT DESCRIPTION

IC Air-Loc® Housing • Energy efficient, sealed housing • Can be completely covered with insulation • When used with Air-Loc Gasket (see accessories), stops infiltration and exfiltration of air, reducing heating and cooling costs • Trims shown with Air-Loc symbol  do not require a gasket.

PRODUCT SPECIFICATIONS

Lamp Lamp ratings based on trim selected—see reverse.

Socket Medium base porcelain with nickel-plated copper screw shell • Adjustable socket plate and detachable socket with snap-in springs to accommodate various lamps and trim combinations • Socket plate secured at two points for consistent, straight lamp positioning.

Trims Trim selection shown on reverse.

Labels U.L. listed for through-branch wiring, damp locations and IP • Product thermally protected against improper use of lamps • UL Listed/CSA certified • Trims 239, 241 and 242 are wet location approved for covered ceiling applications • Trims 28, 29 are wet location approved for covered ceiling applications, **when used with outdoor rated lamps.**

Testing All reports are based on published industry procedures; field performance may differ from laboratory performance.

Product specifications subject to change without notice.

INSTALLATION

Real Nail 3 Bar Hangers Telescoping, Patented (US Patent D552,969) Real Nail 3 system permits quick placement of housing anywhere within 24" O.C. joists or suspended ceilings • Integral T-bar notch and clip secures housing in suspended ceiling grid – no accessory clips required • 24" expansion stop allows quick placement of fixture in standard grid spacing • Bars scored in two locations for fast, clean breaking, allowing housing installation in tight applications • Bars captive to mounting frame • Edge-mounted for extra strength • Captive bugle-headed ring shank nail for quick one-step installation and easy removal with claw hammer for fixture relocation • Quick-Loc slot (location identified on the mounting frame) and oversized locking set screw lock fixture in position • Bar hanger foot contoured to align to bottom of construction joist • Alternate mounting holes included.

Junction Box Pre-wired junction box provided with (5) ½" and (1) ¾" knockouts, (4) Non-metallic sheathed cable connectors and ground wire, U.L. listed/CSA certified for through-branch wiring, maximum 8 No. 12 AWG 90° C branch circuit conductors (4 in, 4 out) • Junction box provided with removable access plates • Knockouts equipped with pryout slots.

Mounting Frame 22-gauge die-formed galvanized steel mounting frame • Rough-in section (junction box, mounting frame, housing and bar hangers) fully assembled for ease of installation • Sight lines embossed on mounting frame to allow for easy viewing when aligning fixtures.

Housing IC housing, .032" aluminum sealed for Air-Loc Compliance • Housing is vertically adjustable to accommodate up to a 1" ceiling thickness.

PRODUCT CODES

Catalog Number	Input Voltage	Lamp Rating (max.)
IC22	120V	A19/BR30/BR40/PAR16/PAR20/PAR30/PAR30L/PAR38/R20 (See reverse for max. trim rating)

REV-5/15

DIMENSIONS

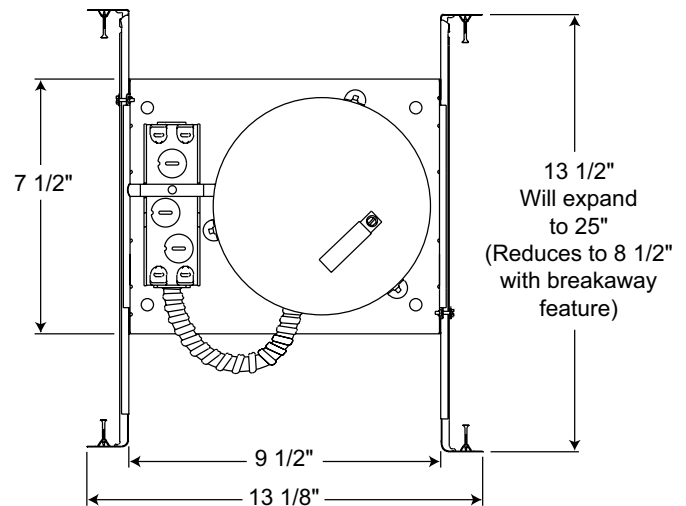
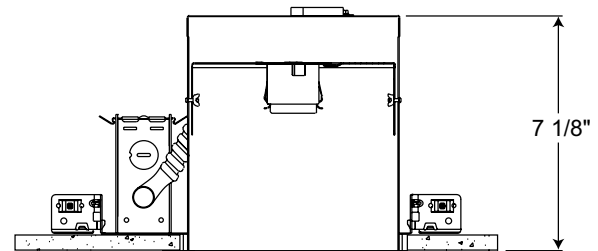

6 7/8" CEILING CUTOUT

ACCESSORIES

Catalog No.	Description
ALG6	Air-Loc Gasket





























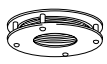

To order, specify catalog number.

6" ECONOMY UNIVERSAL IC HOUSING

INCANDESCENT LAMPS

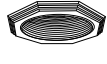
IC22

TRIMS/LAMPS

Cat. No.	Description	Max. Lamp Rating	Cat. No.	Description	Max. Lamp Rating
**  24B-WH 24B-SC 24B-ABZ 24B-BL 24W-WH	Conical Black Baffle Conical Black Baffle Conical Black Baffle Conical Black Baffle Conical White Baffle	50W PAR30, 75W PAR30L, 65W BR30	 248W-WH	R20 Eyeball in White Baffle	50W PAR20/R20
**  25B-WH 25B-SC 25B-ABZ 25B-BL 25W-WH	Straight Black Baffle Straight Black Baffle Straight Black Baffle Straight Black Baffle Straight White Baffle	50W PAR30, 65W BR30	**  264B-WH 264W-WH	PAR30 Adjustable - Black Baffle PAR30 Adjustable - White Baffle	50W PAR30
  28B-WH ◆◆ 28W-WH ◆◆	Conical Black Baffle Conical White Baffle	60W A19, 65W BR30, 75W PAR30/30L, 90W PAR38, 90W BR40	**  267C-WH 267G-WH 267B-WH 267HZ-WH 267WHZ-WH	PAR30 Adjustable - Clear Alzak® PAR30 Adjustable - Gold Alzak® PAR30 Adjustable - Black Alzak® PAR30 Adjustable - Haze PAR30 Adjustable - Wheat Haze	50W PAR30
  29C-WH ◆◆ 29W-WH ◆◆	Deep Cone Clear Cone Deep Cone White Cone	60W A19, 65W BR30, 75W PAR30/30L, 90W PAR38, 90W BR40	 XR30101WH XR30101BL XR30101GP XR30101SL	AVIO Square Gimbal Ring - White AVIO Square Gimbal Ring - Black AVIO Square Gimbal Ring - Graphite AVIO Square Gimbal Ring - Silver	75W PAR30
**  27C-WH 27G-WH 27B-WH 27PT-SC 27W-WH 27HZ-WH 27WHZ-WH 27WHZ-ABZ	Conical Cone in Clear Alzak® Conical Cone in Gold Alzak® Conical Cone in Black Alzak® Conical Cone in Pewter Alzak® Conical Cone in Gloss White Conical Cone in Haze Conical Cone in Wheat Haze Conical Cone in Wheat Haze	50W PAR30, 75W PAR30L, 65W BR30	  239-WH ◆	Frosted Lens	40W A19
  244B-WH 244W-WH	Conical Black Baffle Conical White Baffle	75W PAR30L, 60W PAR30, 65W BR30	  241-WH ◆ 241-PW ◆	Drop Opal with Reflector Shower/Closet Light	40W A19
  247C-WH 247G-WH 247B-WH 247HZ-WH 247WHZ-WH	Cone - Clear Alzak® Cone - Gold Alzak® Cone - Black Alzak® Cone - Haze Cone - Wheat Haze	75W PAR30L, 65W BR30, 75W PAR30	  242-WH ◆ 242-SC ◆ 242-ABZ ◆	Shower Trim, Frosted Lens with Clear Center	45W PAR38
**  250-WH 250-SC 250-ABZ	Open Frame Open Frame Open Frame	65W BR30	 9324-SC	Luminous Disc	50W PAR30, 65W BR30, 75W PAR30
  252-WH	Regressed Open Frame	75W R/BR30	 9702	Luminous Collar	50W PAR30, 65W BR30, 75W PAR30L
 231C-WH 231G-WH 231W-WH	Multiplier - Clear Alzak® Multiplier - Gold Alzak® Multiplier - Gloss White	60W A19	 9024W-WH	White Octagonal w/White Baffle	50W PAR30, 65W BR30, 75W PAR30
 226B-WH 226W-WH	Black Cylinder w/Black Baffle White Cylinder w/White Baffle	60W PAR16	 9524-SC	Chrome Band	65W BR30, 50W PAR30, 75W PAR30L
 228-WH	R20 Regressed Eyeball	50W PAR20/R20			
 229-WH 229-SC 229-ABZ 229-BL	BR30 Regressed Eyeball BR30 Regressed Eyeball BR30 Regressed Eyeball BR30 Regressed Eyeball	75W PAR30L, 65W BR30			

Trim Size: 7 $\frac{7}{8}$ " O.D. (except Cat. Nos. 228, 229, 241, 9024, - 8" O.D.,
Cat. No. 9702 - 7 $\frac{3}{4}$ " O.D.).

Trim Finish: ABZ - Classic Aged Bronze, BL - Black, GP - Graphite,
PW - Plastic White (Polycarbonate material shower trim), SC - Satin Chrome,
SL - Silver, WH - White.

Alzak is a registered trademark of Alcoa Corp.

Note: In Canada when insulation is present, Type IC fixtures must be used.

 JUNO IC housings meet IECC Energy Code requirements per ASTM E283.
Air-Loc® rated trims are pre-gasketed for minimum air leakage with IC housings.

◆ UL Listed for use in wet location.

◆◆ UL Listed for use in wet location with outdoor rated lamp.

** NOTE: TR6 Trim Ring compatible with 24, 25, 27, 244,
247, 264, 267 trims.