



Calculite Evolution Lensed Adjustable Accent **C3MRW**

Page 1 of 2

3" Aperture, MR16 (12V)

Non-IC Frame:

- C3LV**
- C3LVE1**
- C3LVE2**

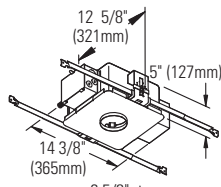

Non-IC AirSeal Frame:

- C3ALV**
- C3ALVE1**
- C3ALVE2**

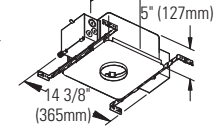

IC AirSeal Frame:

- C3AICLV**
- C3AICLVE1**

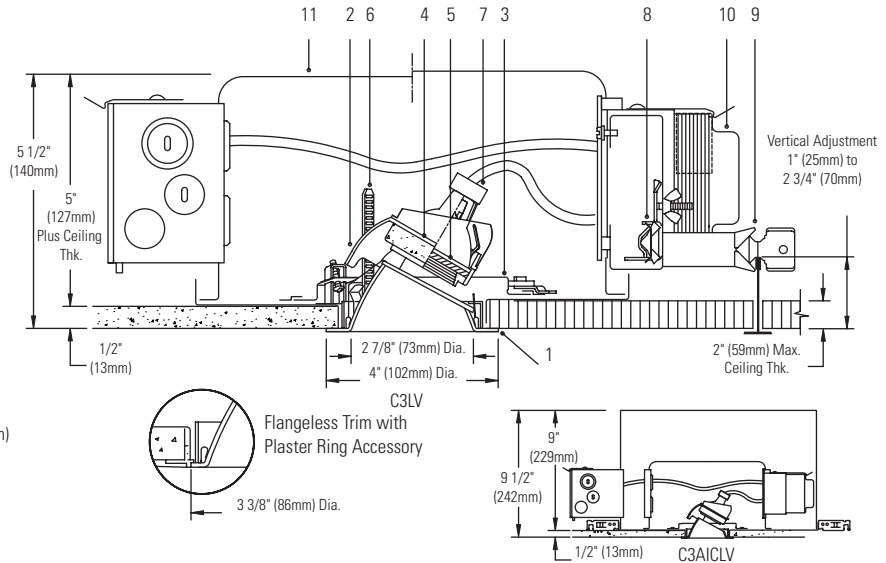
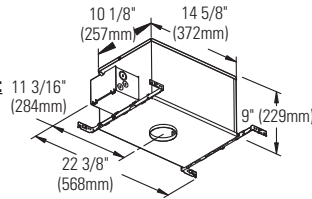

Ceiling Cutout: 3 1/2" (130mm) Dia.

For Complete Fixture Order: Trim Kit + Frame-In Kit. Each Sold Separately.

Trim Kit				Frame-In Kit	Lamp*		
Cone Finish	White Flange	Polished Flange	Flangeless	C3LV	Non-IC	Magnetic 120/277V	42W-65W MR16 (12V)
Clear	C3MRW CLW	C3MRW CLP	C3MRWCLFT	C3LVE1	Non-IC	Electronic 120V	20W-65W MR16 (12V)
Comfort Clear Diffuse	C3MRW CCDW	C3MRW CCDP	C3MRW CCDFT	C3LVE2	Non-IC	Electronic 277V	20W-65W MR16 (12V)
Champagne Bronze	C3MRW CCZW	C3MRW CCZP	C3MRW CCZFT	C3ALV	Non-IC AirSeal®	Magnetic 120/277V	42W-65W MR16 (12V)
Gold	C3MRW GDW	C3MRW GDP	C3MRW GDFT	C3ALVE1	Non-IC AirSeal®	Electronic 120V	20W-65W MR16 (12V)
Matte White	C3MRW WHW	N/A	C3MRW WHFT	C3ALVE2	Non-IC AirSeal®	Electronic 277V	20W-65W MR16 (12V)
Specular Black	C3MRW BKW	C3MRW BKP	C3MRW BKFT	C3AICLV	IC AirSeal®	Magnetic 120V	20W-50W MR16 (12V)
				C3AICLVE1	IC AirSeal®	Electronic 120V	20W-50W MR16 (12V)

Note: Magnetic not recommended for residential or noise sensitive areas.

Features

- Trim Kit Aperture Cone:** Low brightness; 0.040" aluminum, anodized; keyed to lamp support assembly for true aiming of lamp to prevent incorrect installation of cone. Hinged, and snaps on for easy tool-less installation. Captive clear glass shield during relamping. Self-flange in painted white or aperture matching polished flange. Flangeless trim used with Plaster Trim Ring accessory. Interchangeable with other 3" Evolution trims.
- Trim Kit Vertical Adjustment Mechanism:** Die-cast aluminum. Built-in aperture shield blocks view into fixture. Provides 0° - 45° vertical tilt up to 1" thick ceiling, less in thicker ceilings; lockable. 30° maximum tilt in ceilings 1.25" - 2" thick. EZ-Aim Helical Drive System provides fast and accurate hot aiming with Philips screwdriver.
- Horizontal Adjustment Mechanism:** Die-form steel ring, matte black finish. Provides 362° horizontal stop, lockable with Philips screwdriver.
- Lamp Support:** Die-form aluminum with knurled surface for easy gripping during relamping. Spring tension clips hold lamp and lens and allow fast snap-in, snap-out relamping. Matte black finish. Accepts up to two 2" diameter accessories.
- Cover Glass:** High temperature, soft focus lens.
- Thick Ceiling Ready Brackets:** Die-form steel, matte black finish. Adjust trim kit vertically to accommodate up to 2" thick ceiling, lockable.
- Lampholder:** Procelain bi-pin socket. Pre-wired with No.18 AWG PTFE leads.
- Frame Vertical Adjustment Mechanism (C3LV):** Accommodates mounting to virtually any ceiling system using pre-installed mounting bars, or 1/2" EMT tubing (by others). Single locking features secures all adjustments. Alignment holes and markings allow fixture to be pre-set prior to installation. Final adjustment can be made from below inside fixture.
- Mounting Bars (C3LV):** Galvanized steel, 0.048"; pre-installed telescoping bars extend from 20" to 30" long and lock securely into position. Built-in locking tabs provide positive attachment to common T-bar systems. Self-centering feature simplified installation in 24" O.C. grid systems. Attaches to steel or wood joists without accessories.
- Transformer:** Replaceable from below. Magnetic: 120V/277V 60 Hz. dual-voltage, core & coil. **Note:** Magnetic not recommended for residential or noise sensitive areas. Electronic: 120V or 277V 50/60 Hz., regulated lamp voltage, HPF, EMI and circuit protections, thermal auto-reset, quiet operation.

Features (cont.)

- Frame-In Kit:** See Frame-In Kit specification sheets for more information. Non-IC and Non-IC AirSeal - Insulation must be kept 3" away from any parts of the luminaire and must not be placed above luminaire in a manner which will entrap heat. IC AirSeal - Luminaire may be in direct contact with thermal insulation.

Labels

U.L. (Suitable For Wet Locations), I.B.E.W.
 *Lamp wattage restriction for Non-IC: 65W for up to 1" thick ceiling, 50W for ceiling thickness greater than 1" (up to 2").

Options and Accessories

- 2" dia. Color Filters/Specialty filters:** See ADF2/AF2 specification sheets
- 2" Dia. Louver: AL2HC**
- Plaster Trim Ring (use with flangeless trim): CA3FMR**
- Chicago Plenum:** Consult Factory

Job Information	Type:
Job Name:	
Cat. No.:	
Lamp(s):	
Notes:	

Lightolier a Genlyte company www.lightolier.com
 631 Airport Road, Fall River, MA 02720 • (508) 679-8131 • Fax (508) 674-4710
 We reserve the right to change details of design, materials and finish.
 © 2011 Genlyte Group LLC • G0711

LIGHTOLIER®



(FC) is initial footcandles at center of beam. Beam length (L) and beam width (W) are to where the candlepower is reduced to 50% of the center beam candlepower. (C) is the distance to the center of the beam. Footcandles are based on photometry with luminaire, with lamp aimed at 30° from vertical.

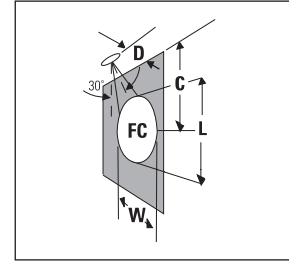
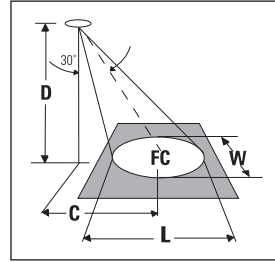

CANDLEPOWER DISTRIBUTION

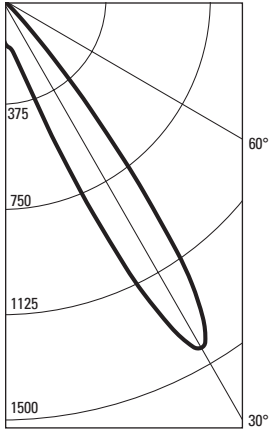

50W MR16 - 15° Spot

ANGLE	WALL	AIMED 30° TOWARD WALL
0	243	
5	376	REFLECTOR TRIM: C3MRWCLW
10	415	GE HALOGEN LAMP
15	568	120V ELECTRONIC TRANSFORMER
20	1144	LUMEN RATING = 750 LMS
25	2456	
30	3348	CBCP= 3348 cd
35	2561	BEAM ANGLE = 15°
40	968	
45	239	CERTIFIED TEST REPORT NO. 2784FR
50	59	DATE: Oct 31, 2004
55	18	**TEST-LITE**
60	2	
65	0	
70	0	
75	0	
80	0	
85	0	
90	0	

**30° Aiming Angle
Horizontal Surface**

D	C	FC	L	W
6'	3.5'	61	2.1'	1.8'
8'	4.6'	34	2.8'	2.4'
10'	5.8'	22	3.5'	3.0'
12'	6.9'	15	4.2'	3.6'
15'	8.7'	10	5.3'	4.6'

**30° Aiming Angle
Vertical Surface**

D	C	FC	L	W
2'	3.5'	135	2.2'	1.1'
3'	5.2'	61	3.3'	1.6'
4'	6.9'	34	4.4'	2.1'
6'	10.4'	15	6.7'	3.2'
8'	13.9'	9	8.9'	4.2'

CANDLEPOWER DISTRIBUTION

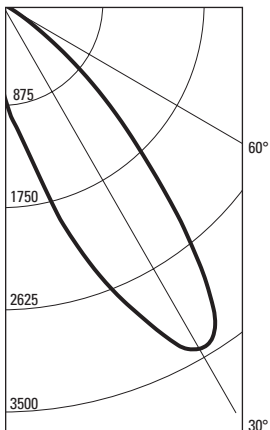

50W MR16 - 25° Narrow Flood

ANGLE	WALL	AIMED 30° TOWARD WALL
0	281	
5	420	REFLECTOR TRIM: C3MRWCLW
10	546	GE HALOGEN LAMP
15	801	120V ELECTRONIC TRANSFORMER
20	1063	LUMEN RATING = 800 LMS
25	1298	
30	1464	CBCP= 1464 cd
35	1368	BEAM ANGLE = 30°
40	1012	
45	657	CERTIFIED TEST REPORT NO. 2785FR
50	384	DATE: Oct 31, 2004
55	168	**TEST-LITE**
60	47	
65	0	
70	0	
75	0	
80	0	
85	0	
90	0	

**30° Aiming Angle
Horizontal Surface**

D	C	FC	L	W
6'	3.5'	27	4.4'	3.7'
8'	4.6'	15	5.9'	5.0'
10'	5.8'	10	7.3'	6.2'
12'	6.9'	7	8.8'	7.4'
15'	8.7'	4	11.0'	9.3'

**30° Aiming Angle
Vertical Surface**

D	C	FC	L	W
2'	3.5'	75	5.5'	2.1'
3'	5.2'	33	8.2'	3.2'
4'	6.9'	19	10.9'	4.3'
6'	10.4'	8	6.4'	6.4'
8'	13.9'	5	21.9'	8.6'

CANDLEPOWER DISTRIBUTION

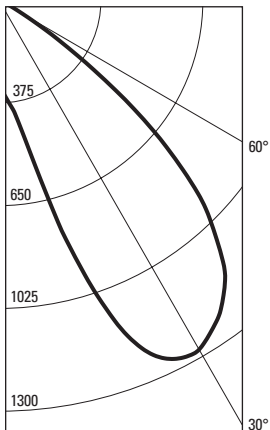

50W MR16 - 40° Flood

ANGLE	WALL	AIMED 30° TOWARD WALL
0	246	
5	319	REFLECTOR TRIM: C3MRWCLW
10	420	GE HALOGEN LAMP
15	727	120V ELECTRONIC TRANSFORMER
20	1079	LUMEN RATING = 800 LMS
25	1250	
30	1276	CBCP= 1276 cd
35	1221	BEAM ANGLE = 36°
40	1120	
45	932	CERTIFIED TEST REPORT NO. 2786FR
50	643	DATE: Oct 31, 2004
55	305	**TEST-LITE**
60	89	
65	13	
70	0	
75	0	
80	0	
85	0	
90	0	

**30° Aiming Angle
Horizontal Surface**

D	C	FC	L	W
6'	3.5'	26	5.4'	4.5'
8'	4.6'	15	7.2'	6.0'
10'	5.8'	9	9.0'	7.5'
12'	6.9'	7	10.8'	9.0'
15'	8.7'	4	13.5'	11.3'

**30° Aiming Angle
Vertical Surface**

D	C	FC	L	W
2'	3.5'	85	7.6'	2.6'
3'	5.2'	39	11.4'	3.9'
4'	6.9'	22	15.2'	5.2'
6'	10.4'	10	22.8'	7.8'
8'	13.9'	6	30.4'	10.4'

Job Information **Type:**

Lightolier a Genlyte company www.lightolier.com
 631 Airport Road, Fall River, MA 02720 • (508) 679-8131 • Fax (508) 674-4710
 We reserve the right to change details of design, materials and finish.
 © 2011 Genlyte Group LLC • G0711