

## CARE INSTRUCTIONS

### Use and care of your lamp.

You have just purchased an original handmade product by LZF. Your lamp is made out FSC® certified natural wood with our patented veneer finish Timberlite®. This treatment both protects and safeguards the wood veneer against breakages.

Depending on the type of lamp use a feather duster, soft cleaning cloth or damp cloth for cleaning. On our more delicate shades, like those made from wood strips, a feather duster or an air blower is preferable. In our more solid shades a damp cloth may be used. Clean only the flat surface of the veneer with the cloth, and please avoid any moisture contact along the edge of the veneer.

### Bulbs

We recommend using energy-saving light bulbs, like the CFL or LED bulbs. Please refer to the instruction manual or visit our website [www.lzf-lamps.com](http://www.lzf-lamps.com) to make sure you are using the right type of bulb.

You can buy bulbs directly from our company; check our catalogues for availability.

### Precautions

Avoid direct sunlight, strong indirect sunlight and moisture on the lamp. Unplug the lamp before cleaning or changing the light bulb. Servicing of the electrical installation should only be performed by qualified electrical personnel by LZF.



SET UP  
USA & CANADA

NUT S UL



[www.lzf-lamps.com](http://www.lzf-lamps.com)  
[contacts@lzf-lamps.com](mailto:contacts@lzf-lamps.com)

© Luziferlamps, S.L. Valencia, Spain. 2014. All rights reserved.

REV. 10-2014

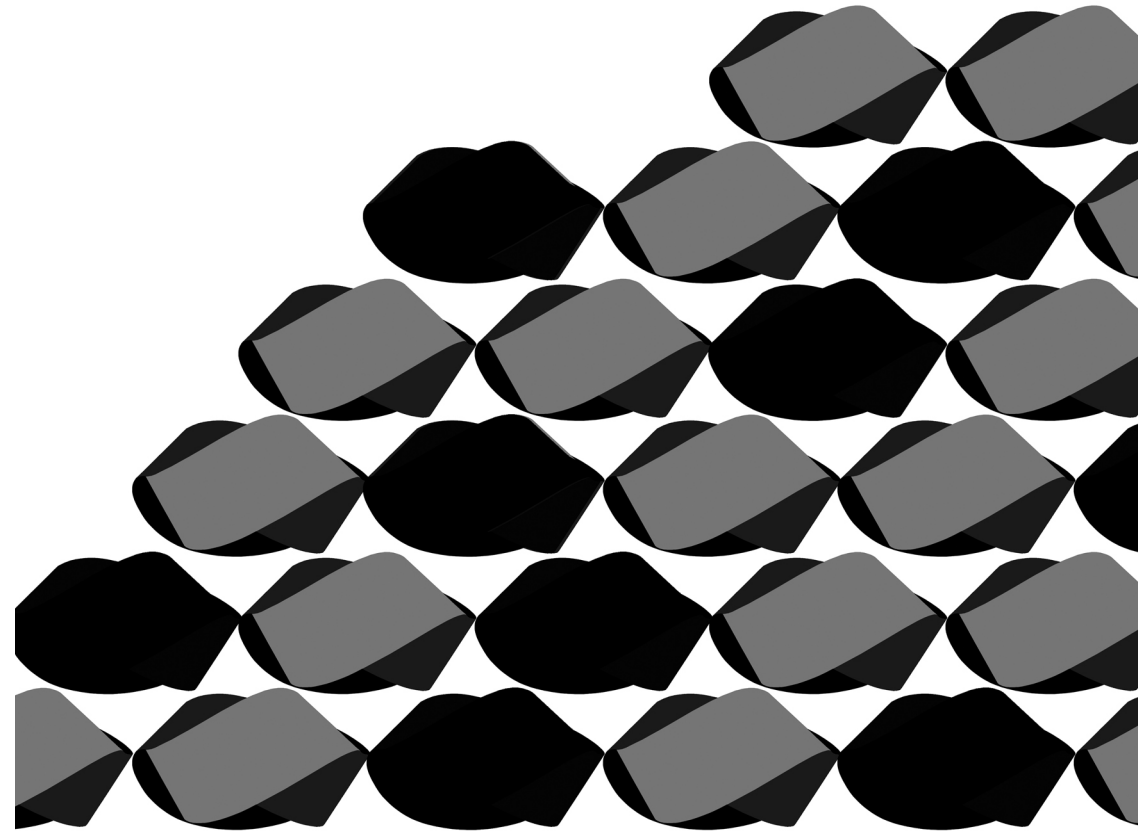

### Lamp Mount

1. Junction box

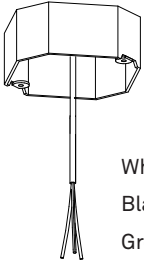

White - NEU  
Black - HOT / LINE  
Green - 

2. Ceiling

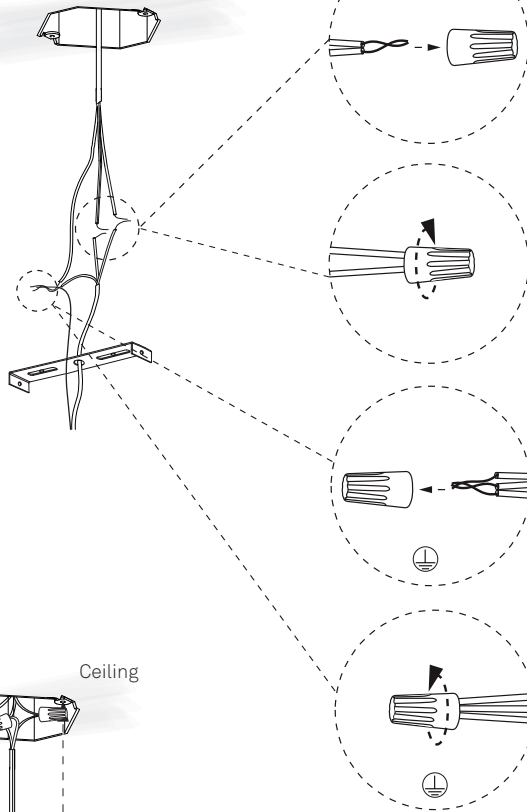

3. Ceiling

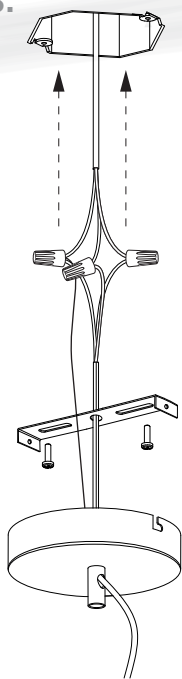

4. Ceiling

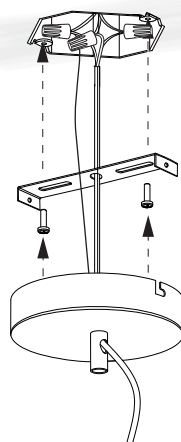

5. Ceiling

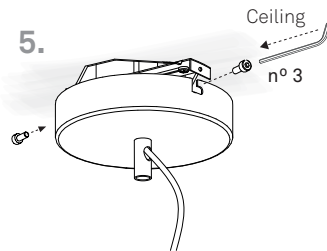

### Ceiling Fixing Fitting

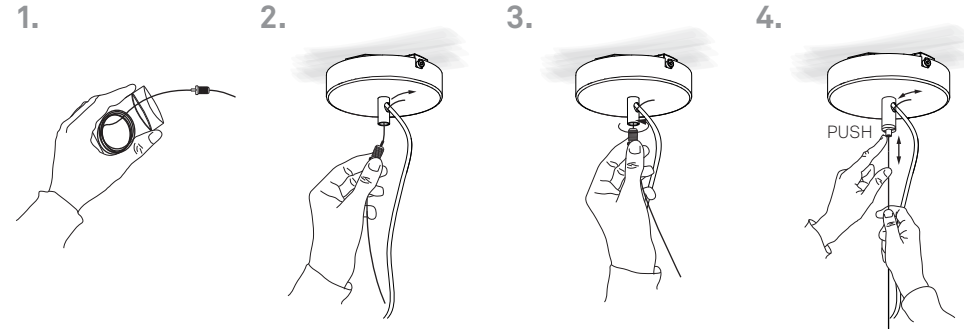

#### ATTENTION

Improper installation may result in shock hazard.  
Please be sure suspension cable remains outside the electrical box.  
See diagram attached for proper installation.

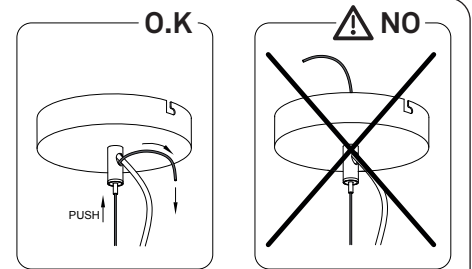

### Shade Mount

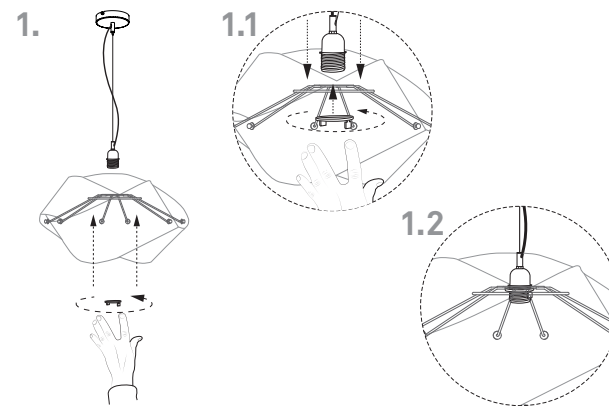

### How to change the bulb

