



**Description:** Reveal projects an indirect glow onto ceilings or floors to deliver cove or pathway lighting. This 24VDC linear LED system features a shallow, plaster-in aluminum extrusion no thicker than drywall that houses a single row of white or color changing LED Soft Strip. System mounts directly to studs without joist modification and plasters into 1/2" or thicker drywall. Reveal is sold in 1 foot increments up to 40 feet (2WDC), 36 feet (3WDC), 20 feet (5WDC), 16 feet (6WDC), 12 feet (7WDC), or 10 feet (10WDC) and may be field-cut to any length. LED Soft Strip may be cut every 2.4 inches. Reveal ships in 8 foot sections. Coordinate installation with electrician and drywall contractors. Fixture includes a 5 year warranty. ETL listed. Patent pending.

**Design Note:** 2.5 watt Reveal is ideal for pathway applications. For cove applications, use 5, 7.5, or 10 watt Reveal.

**Applications:** Indoor Only—Toe-kicks and cove lighting for office, residential, retail, hospitality or institutional settings.

**Lamp:**

Watts per Foot	Lumens per Watt	Lumens per Foot	85+CRI 24k, 35K, 40K, 57K	90+CRI 2K4K	95+CRI 27K, 30K	RGB	RGBW
2WDC	55	179	●		●		
3WDC	N/A	N/A				●	
5WDC	46	246	●	●	●	●	
6WDC	N/A	N/A					●
7WDC	52	453	●		●		
10WDC	50	580	●		●		

Lumen values are based on the 3000K LED test.

**Average Lamp Life:** 50,000 hours

**Power Supply:**

**White LED system, compatible Electronic Low Voltage Dimming (ELV) 120VAC input:**

PSB-60W-ELV-24VDC (24VDC 60W output) | PSB-100W-ELV-24VDC (24VDC 100W output) | PSB-2X100W-ELV-24VDC (24VDC 2X100W output).

**White LED system, compatible 0-10 Volt Dimming (010) 120-277VAC input:**

PSB-96W-010-24VDC (24VDC 96W output) | PSB-2X96W-010-24VDC (24VDC 2X96W output).

**In-Wall Mounting Kits:** PSB-60W-ELV-24VDC-IW | PSB-100W-ELV-24VDC-IW |

PSB-2X100W-ELV-24VDC-IW | PSB-96W-010-24VDC-IW | PSB-2X96W-010-24VDC-IW

**RGB and RGBW LED System:** PSB-100W-24VDC-RGB (24VDC 100W output) |

PSB-2X100W-24VDC-RGB (24VDC 2X100W output) | PSB-3X100W-24VDC-RGB (24VDC 3X100W output)

| PSB-4X100W-24VDC-RGB (24VDC 4X100W output)

**Dimming and Controls:**

**ELV Dimmers:** Legrand: Adorne ADTH700RTU ; Lutron: DIVA DVELV-300P, Skylark SELV-300P and Maestro MAELV-600. **010V Dimmers:** Lutron: Radio Ra2 (with GRX-TVI), Grafik Eye Qs (with GRX-TVI), Diva (with PP20); Nova T; Philips: Sunrise SR1200ZTUNV; Leviton: IP710-DL. **RGB Controls:** Touch Screen Controller with Power Supply (CTP), or Color Dial Controller with Power Supply (CDP).

**Included Components:** Reveal channels, end caps, LED Soft Strip, Reveal Junction Box, Take-Up Box and all mounting hardware. See page 2 of spec sheet for additional details.

**REVEAL ORDERING CODES**

System	Wattage	Length in Feet	Color Temperature	System	Wattage	Length in Feet	Color Temperature
<b>RV - 2WDC - 40FT - 27K</b>				<b>RV - 3WDC - 36FT - RGB</b>			
<b>RV</b> Reveal	<b>2WDC</b> 2.5 Watts/Ft	1-40 Ft	<b>24K</b> 2400K Amber White	<b>RV</b> Reveal	<b>3WDC</b> 3 Watts/Ft	1-36 Ft	<b>RGB</b> Red, Green and Blue
	<b>5WDC</b> 5 Watts/Ft	5WDC 1 to 20 ft	<b>27K</b> 2700K Very Warm White 95+CRI		<b>5WDC</b> 5 Watts/Ft	5WDC 1 to 20 ft	<b>RGBW</b> Red, Green, Blue and 2000K White (6WDC only)
	<b>7WDC</b> 7.5 Watts/Ft	7WDC 1 to 12 ft	<b>30K</b> 3000K Warm White 95+CRI		<b>6WDC</b> 6 Watts/Ft	6WDC 1 to 16 ft	
	<b>10WDC</b> 10 Watts/Ft	10WDC 1 to 10 ft	<b>35K</b> 3500K Neutral White				For custom design and layout assistance, send drawings to design@purelighting.com
			<b>40K</b> 4000K Cool White				
			<b>57K</b> 5700K Daylight White				
			<b>2K4K</b> 2000K-4100K Variable White (5WDC only)				

COMPANY		FIXTURE TYPE		DATE	
PROJECT		APPROVED BY			

Product specification subject to change without notification. REV. 04.15.15



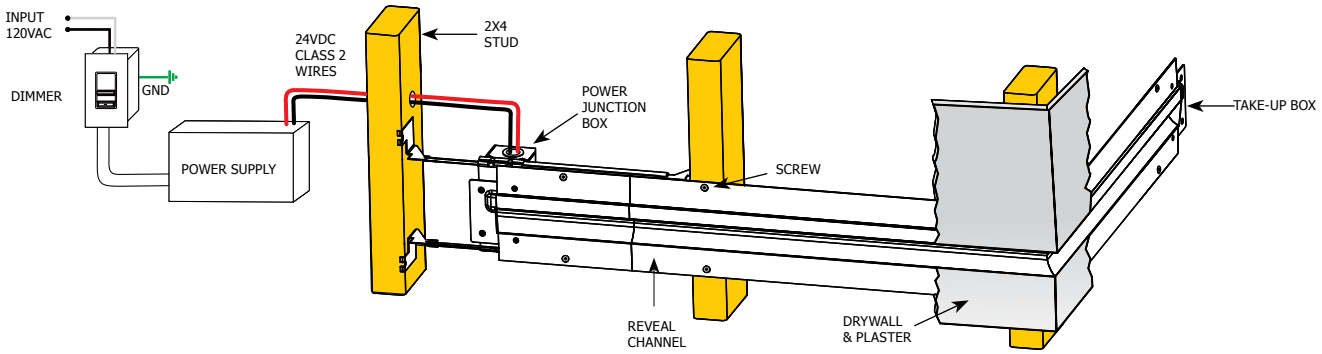
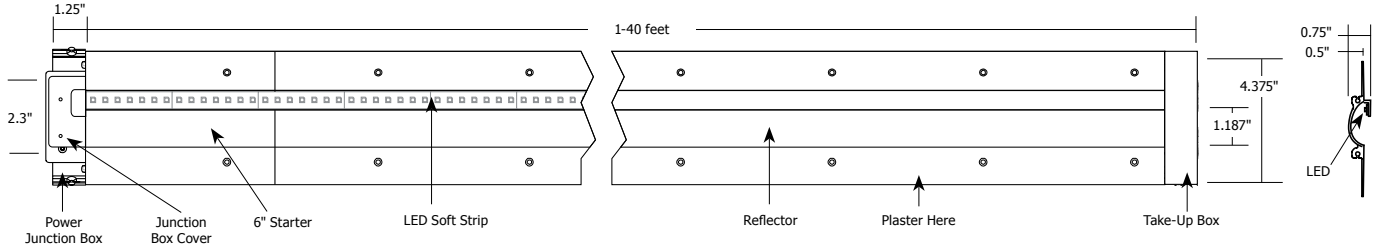

**INCLUDED COMPONENTS**

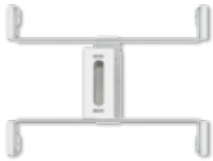

**REVEAL POWER JUNCTION BOX**  
Slim profile junction box mounts behind drywall. Low voltage DC wires from remote power supply connect to LED wires. Junction box opening covered by Reveal channel.



**REVEAL TAKE-UP BOX**  
Prevent dark spots at end of run by tucking excess LED Soft Strip safely behind wall.



**LED SOFT STRIP**  
Commercial grade white or color-changing LED Soft Strip. See Lamp data on page 1 of spec sheet for additional details.

COMPANY		FIXTURE TYPE		DATE	
PROJECT		APPROVED BY			

Product specification subject to change without notification. REV. 04.15.15

A Division of PureEdge Lighting 1718 W. Fullerton Chicago, IL 60614 • Ph: 773.770.1196 • Fax: 773.883.6128 • www.purelighting.com





REVEAL COVE AND PATHWAY APPLICATIONS

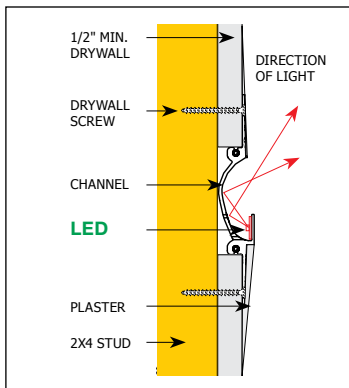
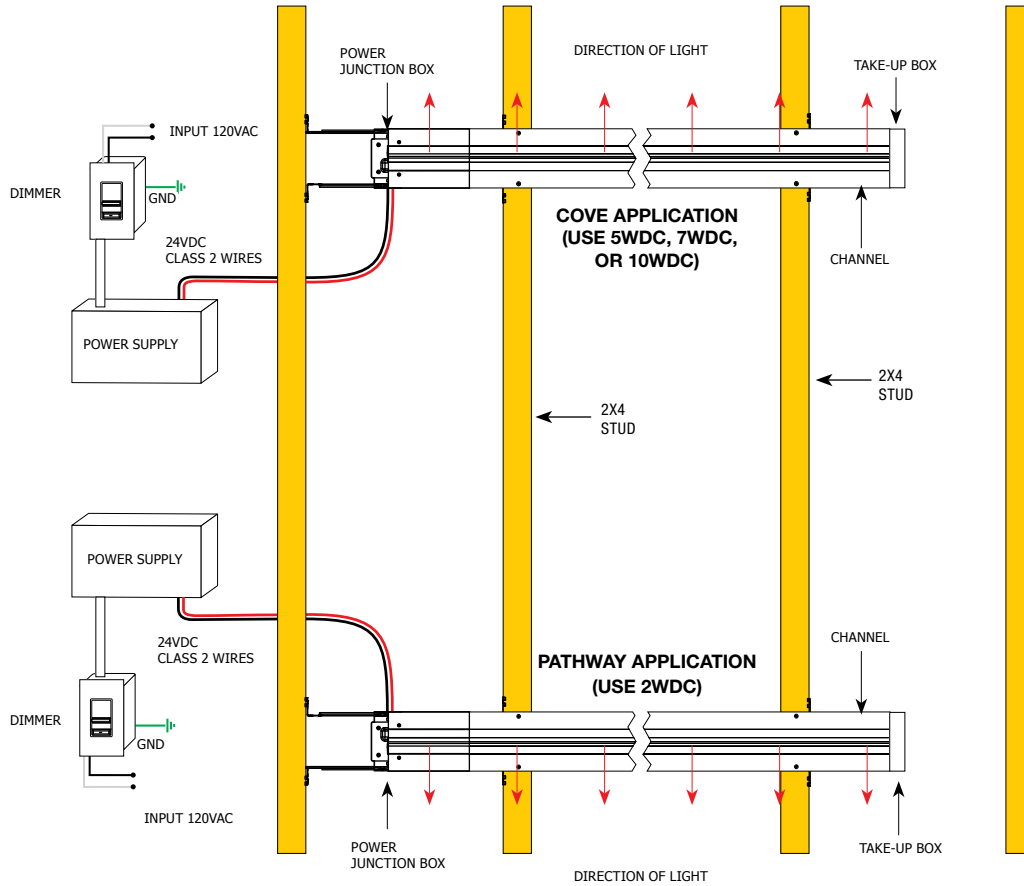

COVE UP-LIGHT CONFIGURATION

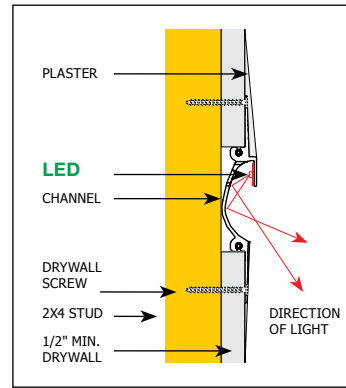

PATHWAY DOWNLIGHT CONFIGURATION, 2W

A Division of PureEdge Lighting 1718 W. Fullerton Chicago, IL 60614 • Ph: 773.770.1196 • Fax: 773.883.6128 • www.purelighting.com



COMPANY		FIXTURE TYPE		DATE	
PROJECT		APPROVED BY			



**Application:** 0-10V dimming for Reveal

**Power Supply:** PSB-96W-010-24VDC (24VDC 96W output) | PSB-2X96W-010-24VDC (24VDC 2X96W output).

**Dimming:** Radio Ra2 (with GRX-TVI), Grafik Eye Qs (with GRX-TVI), Diva (with PP20); Nova T; Philips: Sunrise SR1200ZTUNV; Leviton: IP710-DL.

96W, 24VDC LOW VOLTAGE WIRE SIZE CHART: 3% VOLTAGE DROP

WIRE LENGTH (FT)	UP TO 33FT	34FT-52FT	53FT-86FT	87FT-130FT
WIRE SIZE	14 AWG	12 AWG	10 AWG	8 AWG
VOLTAGE AT END OF WIRE	23.28VDC	23.29VDC	23.28VDC	23.28VDC

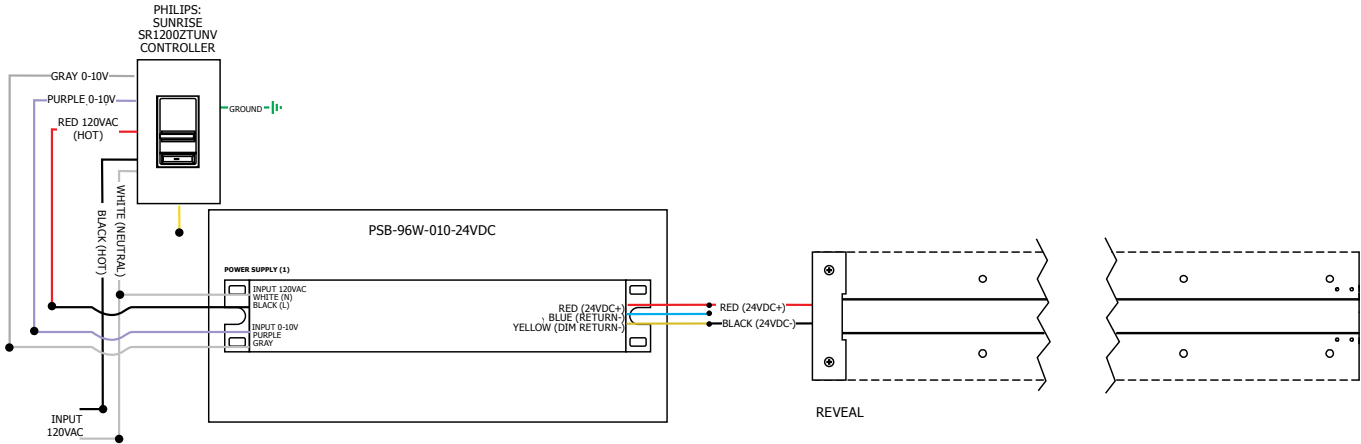

REVEAL PATHWAY FOOT CANDLE DISTRIBUTION  
SHOWN WITH 2.5 WATT 3000K VERSION

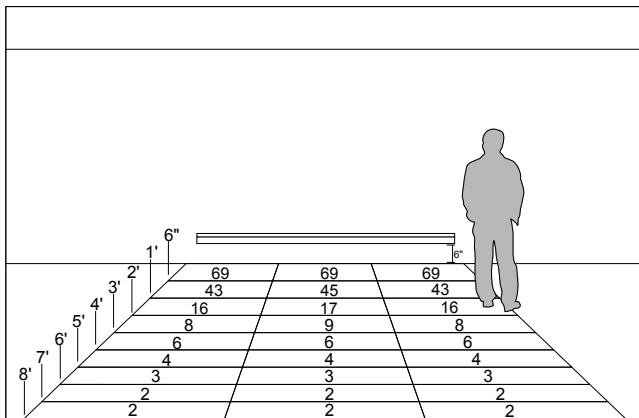

REVEAL COVE FOOT CANDLE DISTRIBUTION  
SHOWN WITH 5 WATT 3000K VERSION

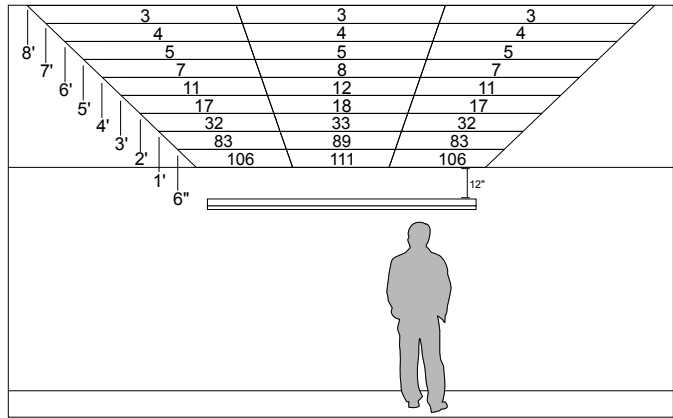

A Division of PureEdge Lighting 1718 W. Fullerton Chicago, IL 60614 • Ph: 773.770.1196 • Fax: 773.883.6128 • www.purelighting.com



COMPANY		FIXTURE TYPE		DATE	
PROJECT		APPROVED BY			

Product specification subject to change without notification. REV. 04.15.15



**2.5 WATTS PER FOOT - 24K, 27K, 30K, 35K, 40K AND 57K WHITE LEDS**

LENGTH IN FEET	WATTS
1	3
2	5
3	8
4	10
5	13
6	15
7	17
8	20
9	22
10	24

LENGTH IN FEET	WATTS
11	27
12	29
13	32
14	34
15	37
16	39
17	41
18	44
19	46
20	48

LENGTH IN FEET	WATTS
21	51
22	54
23	56
24	58
25	61
26	63
27	66
28	68
29	70
30	72

LENGTH IN FEET	WATTS
31	75
32	78
33	80
34	82
35	85
36	87
37	90
38	92
39	94
40	96

**5 WATTS PER FOOT - 24K, 27K, 30K, 35K, 40K, 57K AND 2K4K LEDS**

LENGTH IN FEET	WATTS
1	5
2	10
3	14
4	19
5	24

LENGTH IN FEET	WATTS
6	29
7	34
8	38
9	43
10	48

LENGTH IN FEET	WATTS
11	53
12	58
13	63
14	67
15	72

LENGTH IN FEET	WATTS
16	77
17	82
18	87
19	91
20	96

**7.5 WATTS PER FOOT - 24K, 27K, 30K, 35K, 40K AND 57K LEDS**

LENGTH IN FEET	WATTS
1	8
2	15
3	23

LENGTH IN FEET	WATTS
4	30
5	38
6	45

LENGTH IN FEET	WATTS
7	53
8	60
9	68

LENGTH IN FEET	WATTS
10	75
11	83
12	90

**10 WATTS PER FOOT - 24K, 27K, 30K, 35K, 40K AND 57K LEDS**

LENGTH IN FEET	WATTS
1	10
2	20
3	30

LENGTH IN FEET	WATTS
4	40
5	50
6	60

LENGTH IN FEET	WATTS
7	70
8	80
9	90

LENGTH IN FEET	WATTS
10	100

COMPANY		FIXTURE TYPE		DATE	
PROJECT		APPROVED BY			

Product specification subject to change without notification. REV. 04.15.15

A Division of PureEdge Lighting 1718 W. Fullerton Chicago, IL 60614 • Ph: 773.770.1196 • Fax: 773.883.6128 • www.purelighting.com





**3 WATTS PER FOOT - RGB LEDS**

LENGTH IN FEET	WATTS
1	3
2	5
3	8
4	10
5	13
6	16
7	18
8	21
9	23

LENGTH IN FEET	WATTS
10	26
11	29
12	31
13	36
14	37
15	39
16	42
17	44
18	47

LENGTH IN FEET	WATTS
19	49
20	52
21	55
22	57
23	60
24	62
25	65
26	68
27	70

LENGTH IN FEET	WATTS
28	73
29	75
30	78
31	81
32	83
33	86
34	88
35	91
36	94

**5 WATTS PER FOOT - RGB LEDS**

LENGTH IN FEET	WATTS
1	5
2	10
3	16
4	19
5	24

LENGTH IN FEET	WATTS
6	29
7	34
8	38
9	43
10	48

LENGTH IN FEET	WATTS
11	53
12	58
13	63
14	67
15	72

LENGTH IN FEET	WATTS
16	77
17	82
18	87
19	91
20	96

**6 WATTS PER FOOT - RGBW LEDS**

LENGTH IN FEET	WATTS
1	6
2	12
3	18
4	24

LENGTH IN FEET	WATTS
5	30
6	36
7	42
8	48

LENGTH IN FEET	WATTS
9	54
10	60
11	66
12	72

LENGTH IN FEET	WATTS
13	78
14	84
15	90
16	96

A Division of PureEdge Lighting 1718 W. Fullerton Chicago, IL 60614 • Ph: 773.770.1196 • Fax: 773.883.6128 • www.purelighting.com



COMPANY		FIXTURE TYPE		DATE	
PROJECT		APPROVED BY			