

Description: Reveal, a 24VDC linear LED system features a shallow, plaster-in aluminum extrusion no thicker than drywall. The system may be secured directly to studs without joist modification and plasters into 1/2 inch or thicker drywall, or between studs with mounting clips provided. Sold in 1 foot increments up to 40 feet (2WDC), 36 feet (3WDC), 16 feet (6WDC), 12 feet (7WDC), or 10 feet (10WDC) and may be field-cut to any length. Several color temperature options are available, including 24K – 57K (ELV/010), Warm Dim (ELV), Tunable White (ELV/010/DMX), RGB and RGBW (DMX). High CRI commercial-grade white or dynamic color-changing LED Soft Strip projects a clean line of light. Coordinate installation with electrician and drywall contractors. Includes a 5-year pro-rated warranty.

Design Note: Reveal projects an indirect glow onto ceilings or floors to provide a glare-free solution for both cove or pathway lighting applications. The 2.5 watt Reveal is ideal for pathway applications. For cove, use 5, 7.5, or 10 watt Reveal.

Applications: Indoor damp or dry locations only. Toe-kicks and cove lighting for office, residential, retail, hospitality, and institutions.

Lamp: The average LED Life is 50,000 hours

Watts per Foot	Lumens per Watt	Lumens per Foot	85+CRI 24k, 35K, 40K, 57K	90+CRI 2K4K	92+CRI 27D, 30D	95+CRI 27K, 30K	RGB	RGBW
2WDC (2.5WDC)	55	179	•			•		
3WDC	N/A	N/A					•	
5WDC	46	246	•	•	•	•	•	
6WDC	N/A	N/A						•
7WDC (7.5WDC)	52	453	•			•		
10WDC	50	580	•	•		•		

Lumen values are based on the 3000K LED test.

Remote Power Supplies*, Dimmers & Controls (Sold Separately):

- Electronic Low Voltage Dimming (ELV)
- 0-10 Volt Dimming (0-10V)
- Dynamic Color Changing (DMX)

*In-Wall Mounting Kits available for select power supplies

Included Components: Junction Box, Adjustable Mounting Bars, Reveal Channel(s), Power Feed End Cap, Junction Box Cover, Dead End Cap, Take-Up Box, Drywall Screws, and LED Soft Strip.

ORDERING CODE

REVEAL

System	Watts Per Foot	Length in Feet	Color Temperature
RV	2WDC	40FT	27K
RV Reveal	2WDC 2.5 Watts	1-40FT 2WDC	24K 2400K Amber White
	5WDC 5 Watts	1-20FT 5WDC	27K 2700K Very Warm White
	7WDC 7.5 Watts	1-12FT 7WDC	27D 2700K Warm Dim (5WDC only)
	10WDC 10 Watts	1-10FT 10WDC	30K 3000K Warm White
			30D 3000K Warm Dim (5WDC only)
			35K 3500K Neutral White
			40K 4000K Cool White
			57K 5700K Daylight White
			2K4K 2000K-4000K Tunable White (5WDC & 10WDC only)

REVEAL RGB

System	Watts Per Foot	Length in Feet	Color Temperature
RV	3WDC	36FT	RGB
RV Reveal	3WDC 3 Watts	1-36FT 3WDC	RGB Red, Green, Blue
	5WDC 5 Watts	1-20FT 5WDC	RGBW Red, Green, Blue, 2000K White (6WDC only)
	6WDC 6 Watts	1-12FT 6WDC	

For custom design and layout assistance, send drawings to design@PureEdgeLighting.com

COMPANY		FIXTURE TYPE		DATE	
PROJECT		APPROVED BY			

Product specification subject to change without notification. REV.03.21.17





INCLUDED COMPONENTS

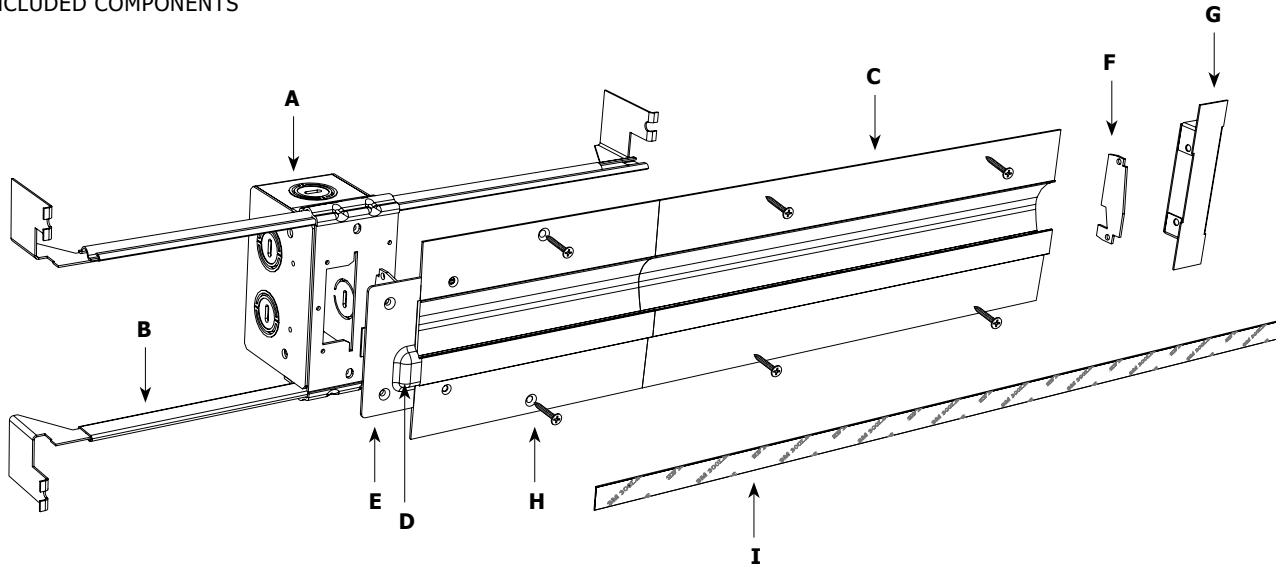

A. Junction Box: Mounts behind drywall with Adjustable Mounting Bars, and includes a drywall template for accurate installation. Low voltage 24VDC wires from Remote Power Supply connect to LED wires inside box. Junction Box opening is concealed with the Reveal Junction Box cover, and is required at the beginning of each run.

B. Adjustable Mounting Bars: Provide flexibility for mounting in a variety of spaces.

C. Reveal Channel: 1/2 inch deep extrusion houses a single row of commercial-grade white or dynamic color-changing LED Soft Strip.

D. Power Feed End Cap: Provides a connection area for 24VDC wires at beginning of run where LED Soft Strip enters channel.

E. Junction Box Cover: Conceals Junction Box opening. Required at the beginning of each run.

F. Dead End Cap Plate: Provides a finished look and prevents light leak at feed-end of run where LED Soft Strip exits channel.

G. Take-Up Box: Prevents dark spots at end of run by tucking excess LED Soft Strip safely behind wall.

H. Drywall Screws: Secure channel to drywall and stud.

I. LED Soft Strip: (Back side shown) Commercial grade white or dynamic color-changing LED Soft Strip. See lamp data on for additional details.

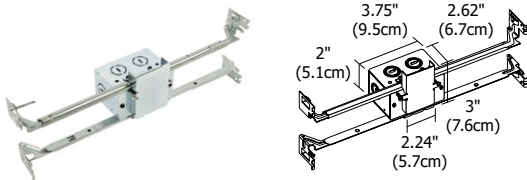

Rough-In Component

Junction Box: One Junction Box is included with Reveal. Order additional Junction Box separately to rough-in electrical wiring before drywall installation. Quick shipment available.

System	Size	Component
RV	1RE	JBOX
RV Reveal	1RE 1 inch Rectangle	JBOX Junction Box

COMPANY		FIXTURE TYPE		DATE	
PROJECT		APPROVED BY			

Product specification subject to change without notification. REV.03.21.17

A Division of PureEdge Lighting 1718 W. Fullerton Chicago, IL 60614 • Ph: 773.770.1196 • Fax: 773.883.6128 • www.purelighting.com





INSTALLATION

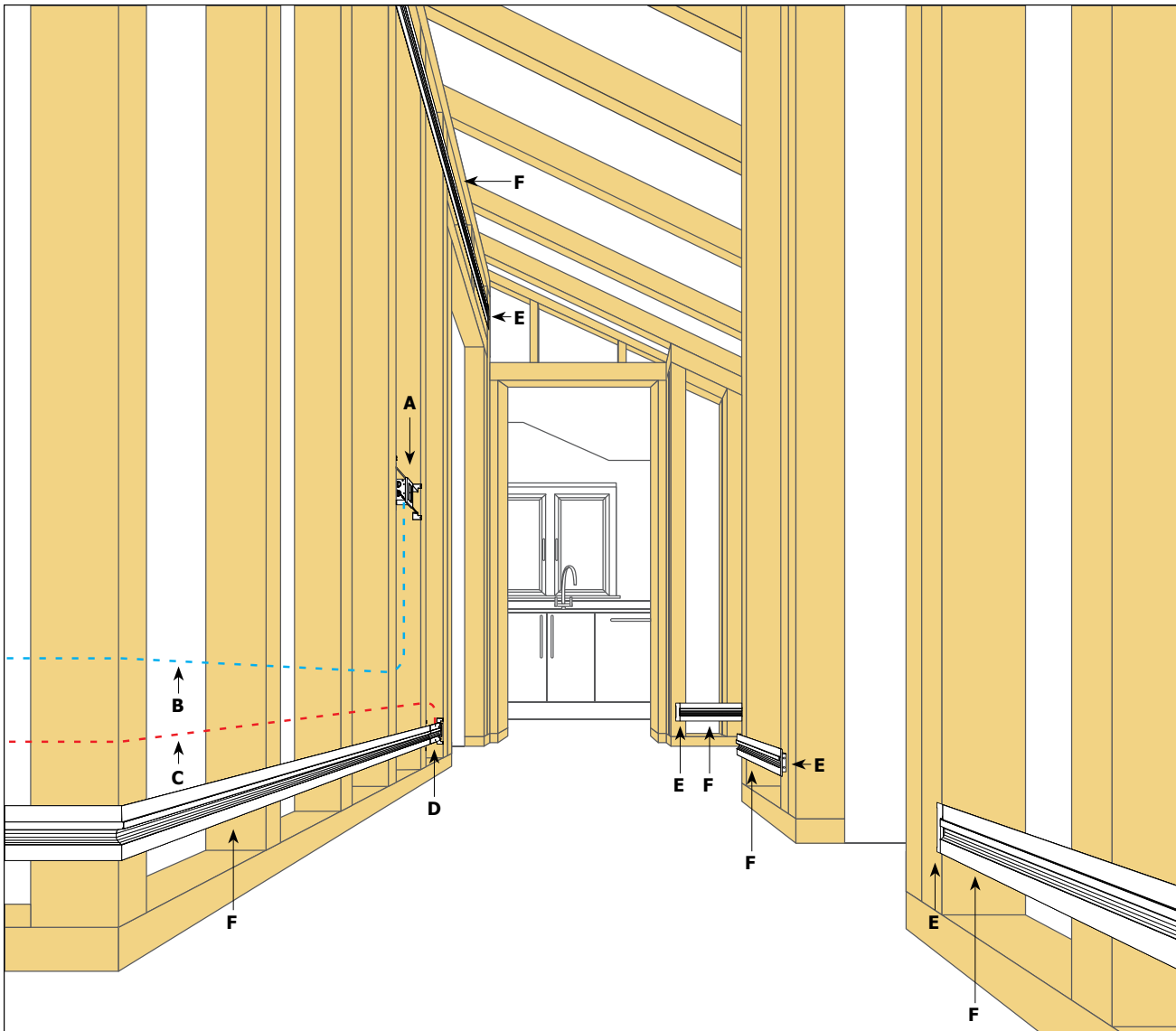

- A.** Dimmer or Switch
- B.** 120VAC wiring to 120V/24VDC remote power supply, for In-Wall Mounting Kit
- C.** 24VDC, Class 2 wiring
- D.** End Feed Power Connector with Junction Box
- E.** Take-Up Box
- F.** Reveal Channel

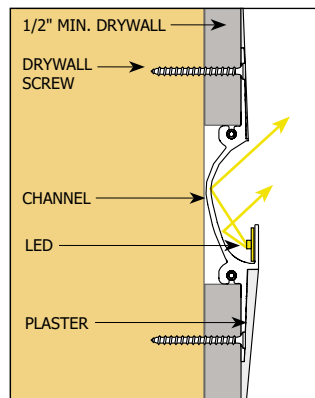

Direction of Light
Cove Up-Light

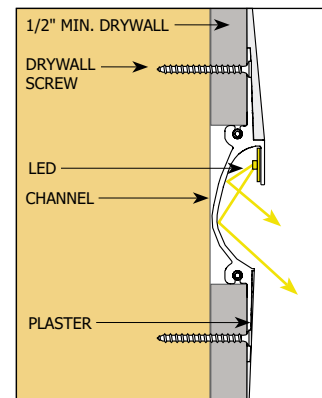

Direction of Light
Pathway Down-Light

COMPANY		FIXTURE TYPE		DATE	
PROJECT		APPROVED BY			

Product specification subject to change without notification. REV.03.21.17

A Division of PureEdge Lighting 1718 W. Fullerton Chicago, IL 60614 • Ph: 773.770.1196 • Fax: 773.883.6128 • www.purelighting.com





Application: 0-10V dimming for Reveal
Power Supply: PSB-96W-010-24VDC (24VDC 96W output) | PSB-2X96W-010-24VDC (24VDC 2X96W output).
Dimming: Radio Ra2 (with GRX-TVI), Grafik Eye Qs (with GRX-TVI), Diva (with PP20); Nova T; Philips: Sunrise SR1200ZTUNV; Leviton: IP710-LF.

96W, 24VDC LOW VOLTAGE WIRE SIZE CHART: 3% VOLTAGE DROP

WIRE LENGTH (FT)	UP TO 33FT	34FT-52FT	53FT-86FT	87FT-130FT
WIRE SIZE	14 AWG	12 AWG	10 AWG	8 AWG
VOLTAGE AT END OF WIRE	23.28VDC	23.29VDC	23.28VDC	23.28VDC

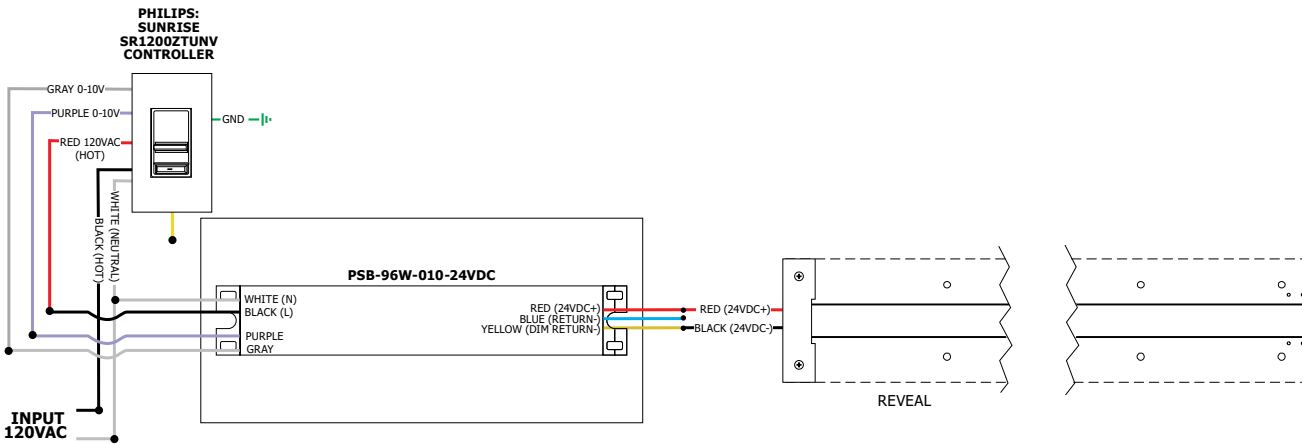

REVEAL PATHWAY FOOT CANDLE DISTRIBUTION
SHOWN WITH 2.5 WATT 3000K VERSION

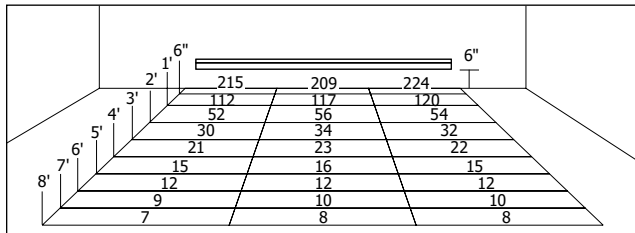

REVEAL COVE FOOT CANDLE DISTRIBUTION
SHOWN WITH 5 WATT 3000K VERSION

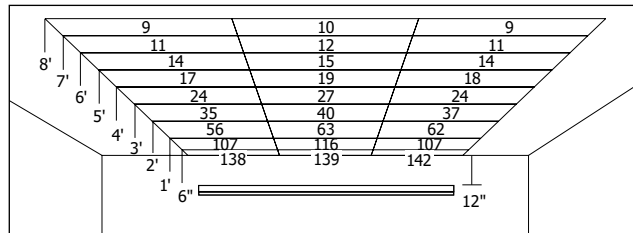

COMPANY		FIXTURE TYPE		DATE	
PROJECT		APPROVED BY			

Product specification subject to change without notification. REV.03.21.17





2.5 WATTS PER FOOT - 24K, 27K, 30K, 35K, 40K AND 57K WHITE LEDS

LENGTH IN FEET	WATTS
1	3
2	5
3	8
4	10
5	13
6	15
7	17
8	20
9	22
10	24

LENGTH IN FEET	WATTS
11	27
12	29
13	32
14	34
15	37
16	39
17	41
18	44
19	46
20	48

LENGTH IN FEET	WATTS
21	51
22	54
23	56
24	58
25	61
26	63
27	66
28	68
29	70
30	72

LENGTH IN FEET	WATTS
31	75
32	78
33	80
34	82
35	85
36	87
37	90
38	92
39	94
40	96

5 WATTS PER FOOT - 24K, 27K, 27D, 30K, 30D, 35K, 40K, 57K AND 2K4K LEDS

LENGTH IN FEET	WATTS
1	5
2	10
3	14
4	19
5	24

LENGTH IN FEET	WATTS
6	29
7	34
8	38
9	43
10	48

LENGTH IN FEET	WATTS
11	53
12	58
13	63
14	67
15	72

LENGTH IN FEET	WATTS
16	77
17	82
18	87
19	91
20	96

7.5 WATTS PER FOOT - 24K, 27K, 30K, 35K, 40K AND 57K WHITE LEDS

LENGTH IN FEET	WATTS
1	8
2	15
3	23

LENGTH IN FEET	WATTS
4	30
5	38
6	45

LENGTH IN FEET	WATTS
7	53
8	60
9	68

LENGTH IN FEET	WATTS
10	75
11	83
12	90

10 WATTS PER FOOT - 24K, 27K, 30K, 35K, 40K, 57K AND 2K4K LEDS

LENGTH IN FEET	WATTS
1	10
2	20
3	30

LENGTH IN FEET	WATTS
4	40
5	50
6	60

LENGTH IN FEET	WATTS
7	70
8	80
9	90

LENGTH IN FEET	WATTS
10	100

COMPANY		FIXTURE TYPE		DATE	
PROJECT		APPROVED BY			

Product specification subject to change without notification. REV.03.21.17

A Division of PureEdge Lighting 1718 W. Fullerton Chicago, IL 60614 • Ph: 773.770.1196 • Fax: 773.883.6128 • www.purelighting.com





3 WATTS PER FOOT - RGB LEDS

LENGTH IN FEET	WATTS
1	3
2	5
3	8
4	100
5	13
6	16
7	18
8	21
9	23

LENGTH IN FEET	WATTS
10	26
11	29
12	31
13	36
14	37
15	39
16	42
17	44
18	47

LENGTH IN FEET	WATTS
19	49
20	52
21	55
22	57
23	60
24	62
25	65
26	68
27	70

LENGTH IN FEET	WATTS
28	73
29	75
30	78
31	81
32	83
33	86
34	88
35	91
36	94

5 WATTS PER FOOT - RGB LEDS

LENGTH IN FEET	WATTS
1	5
2	10
3	16
4	19
5	24

LENGTH IN FEET	WATTS
6	29
7	34
8	38
9	43
10	48

LENGTH IN FEET	WATTS
11	53
12	58
13	63
14	67
15	72

LENGTH IN FEET	WATTS
16	77
17	82
18	87
19	91
20	96

6 WATTS PER FOOT - RGBW LEDS

LENGTH IN FEET	WATTS
1	6
2	12
3	18
4	24

LENGTH IN FEET	WATTS
5	30
6	36
7	42
8	48

LENGTH IN FEET	WATTS
9	54
10	60
11	66
12	72

LENGTH IN FEET	WATTS
13	78
14	84
15	90
16	96

A Division of PureEdge Lighting 1718 W. Fullerton Chicago, IL 60614 • Ph: 773.770.1196 • Fax: 773.883.6128 • www.purelighting.com



COMPANY		FIXTURE TYPE		DATE	
PROJECT		APPROVED BY			



TM-30-15 DATA: The data below is for SS2C, SS5C, SS7C, and SS10C bare LED Soft Strips. Consistent color temperatures throughout a single strip and among multiple strips is possible through a 3 phase binning process in which each order is inspected with a color meter to ensure uniformity.

2400K | Rf: 83.9 | Rg: 94.9

COLOR VECTOR GRAPHIC

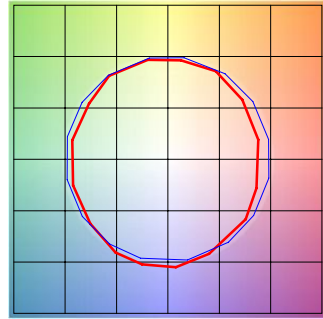

■ Test ■ Reference

HUE BIN	Rf	GRAPHIC SHIFTS %	
		CHROMA	HUE
1	77.6	-10.0%	1.8%
2	80.7	-7.5%	7.0%
3	79.5	-2.9%	8.9%
4	90.5	-3.1%	2.4%
5	93.9	-1.3%	1.9%
6	91.9	-0.9%	-0.2%
7	87.6	-6.3%	-2.7%
8	90.5	-5.4%	2.7%
9	83.8	-4.7%	6.5%
10	81.2	-2.5%	10.0%
11	83.3	3.9%	9.4%
12	86.4	5.6%	2.6%
13	86.2	4.5%	-12.4%
14	64.3	-1.0%	-21.9%
15	85.1	-4.4%	-7.5%
16	75.0	-9.9%	-12.0%

2700K | Rf: 87.7 | Rg: 96.1

COLOR VECTOR GRAPHIC

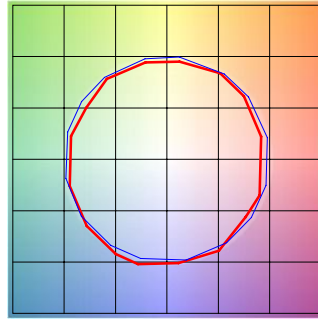

■ Test ■ Reference

HUE BIN	Rf	GRAPHIC SHIFTS %	
		CHROMA	HUE
1	86.4	-5.6%	2.3%
2	89.7	-3.3%	3.1%
3	90.5	-1.5%	3.8%
4	90.0	-4.3%	1.1%
5	92.9	-3.7%	0.2%
6	93.5	-2.5%	-0.8%
7	86.3	-7.2%	2.5%
8	90.7	-4.0%	3.2%
9	85.2	-2.4%	8.1%
10	81.7	0.9%	10.8%
11	85.4	4.5%	8.9%
12	88.7	5.7%	-1.4%
13	88.3	1.3%	-7.9%
14	85.1	2.4%	-10.4%
15	88.1	-4.8%	-2.7%
16	81.7	-4.3%	-10.9%

3000K | Rf: 88.1 | Rg: 99.7

COLOR VECTOR GRAPHIC

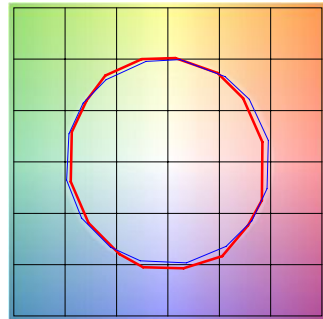

■ Test ■ Reference

HUE BIN	Rf	GRAPHIC SHIFTS %	
		CHROMA	HUE
1	87.7	-5.9%	-0.3%
2	87.9	-4.4%	4.3%
3	82.9	-1.2%	7.9%
4	89.9	0.6%	4.7%
5	92.7	3.0%	3.5%
6	92.7	3.6%	-1.7%
7	90.8	-1.3%	-4.4%
8	93.7	-2.5%	-2.2%
9	91.7	-3.7%	2.3%
10	85.5	-2.8%	7.8%
11	83.3	0.7%	11.0%
12	86.4	5.5%	3.8%
13	90.6	4.6%	-3.6%
14	85.6	5.9%	-8.4%
15	89.5	-0.6%	-5.7%
16	82.6	-2.7%	-12.0%

3500K | Rf: 86.1 | Rg: 95.5

COLOR VECTOR GRAPHIC

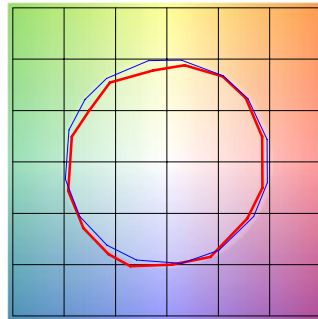

■ Test ■ Reference

HUE BIN	Rf	GRAPHIC SHIFTS %	
		CHROMA	HUE
1	86.6	-4.2%	3.4%
2	91.7	-1.4%	1.8%
3	94.9	-0.7%	0.4%
4	87.9	-4.5%	-4.1%
5	85.9	-10.3%	-2.7%
6	89.8	-5.2%	-0.4%
7	79.6	-9.5%	6.5%
8	87.6	-4.0%	5.7%
9	81.4	-0.5%	11.8%
10	78.3	3.3%	11.4%
11	85.7	6.3%	6.1%
12	86.3	7.1%	-4.6%
13	86.1	-0.7%	-9.6%
14	85.1	0.8%	-10.4%
15	83.4	-4.1%	-5.3%
16	82.5	-3.6%	-5.7%

4000K | Rf: 87.6 | Rg: 96.8

COLOR VECTOR GRAPHIC

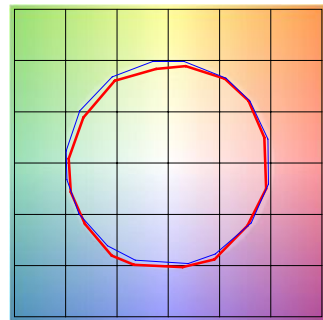

■ Test ■ Reference

HUE BIN	Rf	GRAPHIC SHIFTS %	
		CHROMA	HUE
1	89.0	-3.1%	2.1%
2	93.2	-0.9%	1.3%
3	94.3	-1.1%	0.7%
4	89.5	-4.0%	-2.3%
5	87.6	-7.8%	-1.8%
6	92.2	-4.6%	0.1%
7	87.4	-6.6%	3.6%
8	85.7	-3.8%	7.0%
9	81.5	-1.3%	12.4%
10	80.0	0.9%	11.4%
11	83.3	5.9%	8.7%
12	89.7	4.8%	-0.3%
13	88.5	2.4%	-6.3%
14	92.7	4.0%	-3.8%
15	86.1	-1.6%	-4.5%
16	85.0	-1.4%	-5.0%

5700K | Rf: 80.3 | Rg: 91.5

COLOR VECTOR GRAPHIC

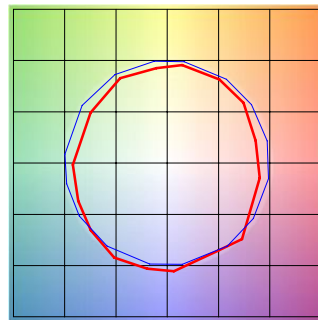

■ Test ■ Reference

HUE BIN	Rf	GRAPHIC SHIFTS %	
		CHROMA	HUE
1	73.8	-11.2%	2.6%
2	83.7	-5.5%	5.8%
3	84.2	-4.0%	5.5%
4	85.8	-3.5%	1.3%
5	85.3	-7.1%	0.6%
6	89.2	-5.8%	-2.2%
7	81.5	-10.7%	1.2%
8	75.7	-9.7%	8.5%
9	74.9	-7.8%	18.8%
10	67.8	-1.6%	18.0%
11	76.1	5.5%	12.0%
12	90.8	4.9%	-1.6%
13	83.6	5.0%	-9.5%
14	81.7	-1.2%	-10.0%
15	69.0	2.0%	-22.8%
16	83.2	-8.5%	-1.0%

A Division of PureEdge Lighting 1718 W. Fullerton Chicago, IL 60614 • Ph: 773.770.1196 • Fax: 773.883.6128 • www.purelighting.com



COMPANY		FIXTURE TYPE		DATE	
PROJECT		APPROVED BY			



TM-30-15 DATA: The data below is for SS2C, SS5C, SS7C, and SS10C bare LED Soft Strips. Consistent color temperatures throughout a single strip and among multiple strips is possible through a 3 phase binning process in which each order is inspected with a color meter to ensure uniformity.

2700D | Rf: 89.5 | Rg: 100.8

COLOR VECTOR GRAPHIC

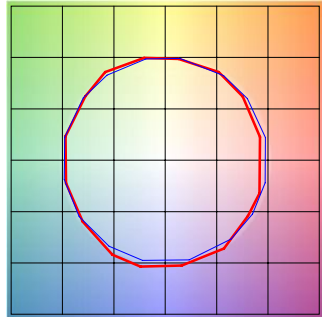

■ Test ■ Reference

GRAPHIC SHIFTS %			
HUE BIN	Rf	CHROMA	HUE
1	88.8	-5.1%	1.4%
2	89.8	-2.7%	4.1%
3	87.2	0.3%	5.9%
4	92.3	-0.9%	1.0%
5	93.3	1.5%	1.7%
6	92.4	3.6%	-0.2%
7	92.2	-0.9%	-2.4%
8	96.7	-0.4%	-1.1%
9	92.3	-1.2%	3.7%
10	88.9	-0.0%	6.1%
11	86.4	5.1%	7.4%
12	88.2	6.3%	-0.9%
13	87.2	3.8%	-8.1%
14	84.2	3.8%	-11.0%
15	89.8	-2.6%	-4.3%
16	82.7	-3.4%	-11.1%

3000D | Rf: 89.8 | Rg: 101.4

COLOR VECTOR GRAPHIC

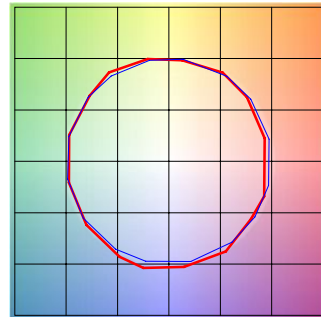

■ Test ■ Reference

GRAPHIC SHIFTS %			
HUE BIN	Rf	CHROMA	HUE
1	90.2	-4.2%	1.5%
2	90.9	-2.0%	3.7%
3	87.9	0.8%	5.5%
4	92.1	-0.9%	0.6%
5	93.0	1.5%	1.6%
6	92.2	3.9%	-0.2%
7	92.1	-0.3%	-2.0%
8	96.7	0.0%	-1.2%
9	92.5	-0.6%	3.7%
10	88.3	1.1%	7.0%
11	87.2	4.1%	7.4%
12	87.2	6.7%	-1.0%
13	88.2	3.8%	-7.2%
14	85.3	4.3%	-9.9%
15	90.9	-2.2%	-3.6%
16	83.4	-2.2%	-11.2%

2000K only (2K4K) | Rf: 84.3 | Rg: 96.9

COLOR VECTOR GRAPHIC

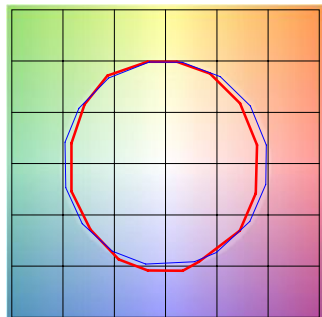

■ Test ■ Reference

GRAPHIC SHIFTS %			
HUE BIN	Rf	CHROMA	HUE
1	80.3	-8.9%	1.7%
2	79.7	-7.0%	7.8%
3	78.9	-2.9%	10.0%
4	89.5	-0.5%	5.1%
5	94.4	0.7%	1.7%
6	92.1	2.4%	-0.3%
7	89.4	-2.4%	-5.9%
8	89.7	-6.4%	-0.2%
9	86.0	-4.9%	4.6%
10	81.8	-3.4%	9.3%
11	83.1	3.3%	9.7%
12	85.8	5.6%	3.3%
13	85.6	6.2%	-12.8%
14	61.7	-1.9%	-19.0%
15	79.7	-3.3%	-12.9%
16	78.1	-7.9%	-10.6%

4000K only (2K4K) | Rf: 89.6 | Rg: 99.1

COLOR VECTOR GRAPHIC

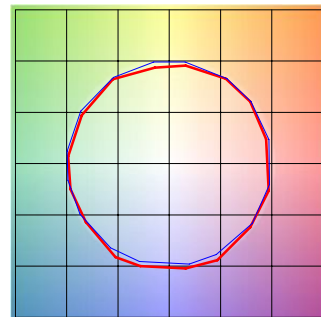

■ Test ■ Reference

GRAPHIC SHIFTS %			
HUE BIN	Rf	CHROMA	HUE
1	91.3	-2.5%	1.0%
2	95.3	-0.5%	0.5%
3	94.3	-0.7%	1.1%
4	91.1	-3.4%	-1.1%
5	89.5	-5.6%	0.0%
6	94.6	-1.4%	1.3%
7	93.2	-3.0%	2.6%
8	91.3	-1.8%	4.6%
9	86.5	-0.9%	9.1%
10	83.3	-0.5%	9.5%
11	83.3	4.9%	9.0%
12	89.7	4.1%	1.7%
13	90.1	3.6%	-4.3%
14	93.4	5.2%	-2.1%
15	87.4	0.4%	-4.3%
16	86.6	0.4%	-6.1%

2K4K (3000K) | Rf: 90.2 | Rg: 101.4

COLOR VECTOR GRAPHIC

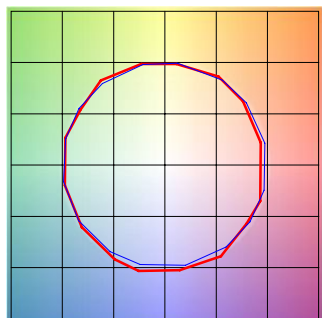

■ Test ■ Reference

GRAPHIC SHIFTS %			
HUE BIN	Rf	CHROMA	HUE
1	90.9	-3.8%	1.3%
2	91.7	-1.9%	3.3%
3	88.7	0.7%	5.1%
4	92.4	-1.0%	0.7%
5	92.9	0.9%	1.7%
6	93.1	3.3%	-0.6%
7	91.0	-1.8%	-0.4%
8	97.0	0.2%	-1.1%
9	92.8	-0.5%	3.6%
10	88.3	1.0%	7.0%
11	87.1	3.8%	7.8%
12	87.6	6.5%	-0.3%
13	89.3	3.6%	-6.3%
14	86.1	4.5%	-9.1%
15	91.6	-1.9%	-3.1%
16	83.8	-1.5%	-11.2%

A Division of PureEdge Lighting 1718 W. Fullerton Chicago, IL 60614 • Ph: 773.770.1196 • Fax: 773.883.6128 • www.purelighting.com



COMPANY		FIXTURE TYPE		DATE	
PROJECT		APPROVED BY			