

**Description:** TruLine .5A, a versatile 24VDC linear plaster-in LED system, creates glare-free, indoor architectural lighting. The system recesses into 5/8 inch thick drywall without joist modification. May be secured to studs that are spaced 13 – 24 inches apart, or between studs with mounting clips provided. TruLine .5A is sold in 1 foot increments up to 40 feet (2WDC, white LEDs only), 20 feet (5WDC, white, 2K4K or RGB LEDs) or 16 feet (6WDC, RGBW) and may be field-cut to any length. Several color temperature options are available, including 22K – 57K (ELV/010), Warm Dim (ELV), Tunable White (ELV/010/DMX), RGB and RGBW (DMX). High CRI commercial-grade white or dynamic color-changing LED Soft Strip projects a clean line of light. Coordinate installation with electrician and drywall contractors. Includes a 5-year pro-rated warranty.

**Design Note:** TruLine .5A can be installed on a single surface (wall or ceiling), on multiple planes that join runs from wall to ceiling, or from one wall to an adjacent wall. Use TruLine .5A Build-It-Yourself (BIY) with Pre-Formed Components to create desired configurations including Picture Frame Miter and Room Wrapping installations. Create rectangle or square installations using TruQuad .5A.

**Applications:** Indoor damp or dry locations only. General illumination and architectural accent for kitchens, offices, hospitality, retail, residences, libraries, hallways, and bath/vanity.

**Lamp:** The average LED Life is 50,000 hours

Watts per Foot	Lumens per Watt	Lumens per Foot	85+CRI 22K, 35K, 40K, 57K	90+CRI 2K4K	92+CRI 27D, 30D	95+CRI 27K, 30K	RGB	RGBW
2WDC (2.5WDC)	52	169	•			•		
5WDC	50	244	•	•	•	•	•	
6WDC	N/A	N/A						•

Lumen values are based on the 3000K LED test.

**Remote Power Supplies\*, Dimmers & Controls (Sold Separately):**

- Electronic Low Voltage Dimming (ELV)
- 0-10 Volt Dimming (0-10V)
- Dynamic Color Changing (DMX)

\*In-Wall Mounting Kits available for select power supplies

**Included Components:** Junction Box, Adjustable Mounting Bars, TruLine .5A Channel(s), End Cap, Take-Up Box, Mounting Straps, Drywall Screws, LED Soft Strip, and Lens(es)

**ORDERING CODE**

System	Watts Per Foot	Length in Feet	Color Temperature
<b>TL.5A</b>	<b>2WDC</b>	<b>40FT</b>	<b>27K</b>
TL.5A TruLine .5A	2WDC 2.5 Watts (40 ft Max) 5WDC 5 Watts (20 ft Max) 6WDC 6 Watts (16 ft Max)	1-40FT 2WDC 1-20FT 5WDC 1-16FT 6WDC	22K 2200K Amber White 27K 2700K Very Warm White 27D 2700K Warm Dim (5WDC Only) 30K 3000K Warm White 30D 3000K Warm Dim (5WDC Only) 35K 3500K Neutral White 40K 4000K Cool White 57K 5700K Daylight White 2K4K 2000K - 4000K Tunable White (5WDC Only) RGB Red, Green, and Blue (5WDC Only) RGBW Red, Green, Blue, and 2000K White (6WDC Only)

For custom design and layout assistance, send drawings to design@PureEdgeLighting.com

COMPANY		FIXTURE TYPE		DATE	
PROJECT		APPROVED BY			

Product specification subject to change without notification. REV.04.06.17





INCLUDED COMPONENTS

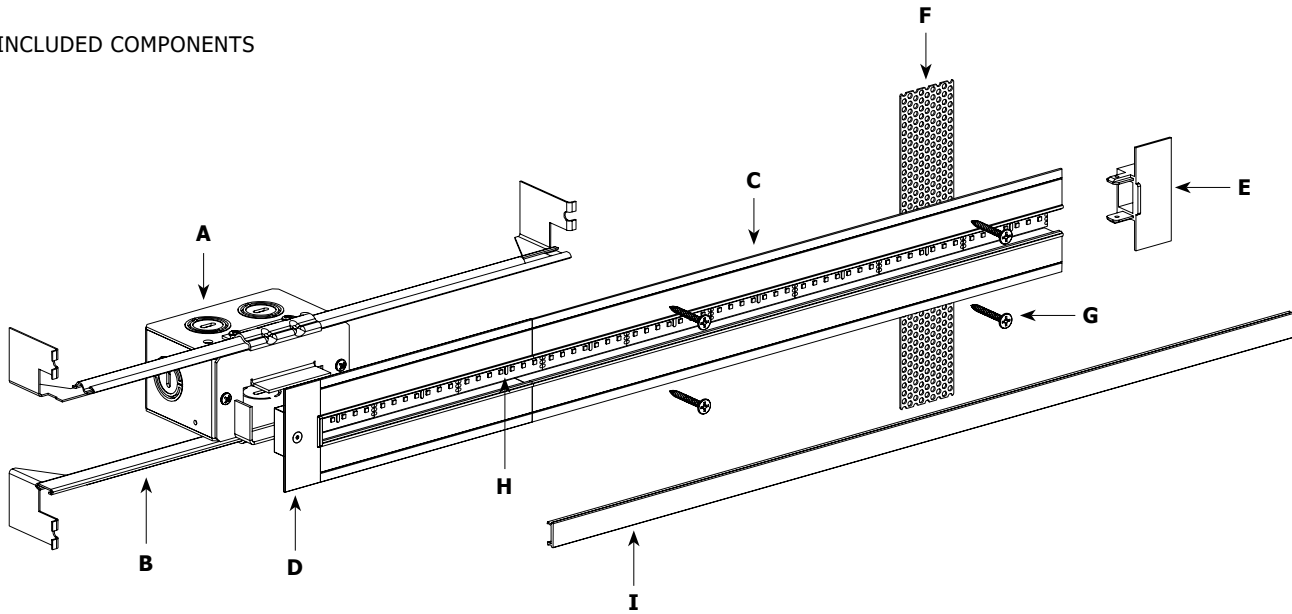

**A. Junction Box:** Mounts behind drywall with Adjustable Mounting Bars. Low voltage 24VDC wires from remote power supply connect to LED wires inside box. Junction Box opening is covered by channel. Required at the beginning of each run and necessary to rough-in electrical before TruLine installation. Junction Box is also included with each TruLine channel order.

**B. Adjustable Mounting Bars:** Provide flexibility for mounting in a variety of spaces and orientations. May be secured to studs that are spaced 13 - 24 inches apart.

**C. TruLine .5A Channel:** 5/8 inch deep extrusion houses a single row of commercial-grade white or dynamic color-changing LED Soft Strip.

**D. End Cap:** Provides a finished look and prevents light leak at feed-end of run where LED Soft Strip enters channel.

**E. Take-Up Box:** Prevents dark spots at end of run by tucking excess LED Soft Strip safely behind wall.

**F. Mounting Strap:** Secures channel to drywall when wall stud is unavailable.

**G. Drywall Screw:** Secures channel to drywall and stud.

**H. LED Soft Strip:** Commercial grade white or dynamic color-changing LED Soft Strip.

**I. Lens:** 0.5 inch wide diffuser lens projects a clean line of light without LED dots.

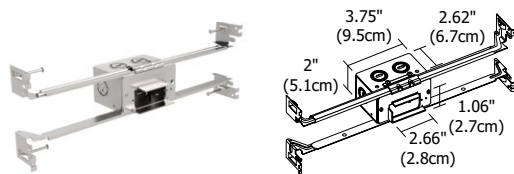

**Rough-In Component**

**Junction Box:** One Junction Box is included with TruLine .5A. Order additional Junction Box separately to rough-in electrical wiring before drywall installation. Quick shipment available.

System	Size	Component
<b>TL.5A</b>	-	<b>1RE</b> - <b>JBOX</b>
TL.5A TruLine .5A	1RE 1" Rectangle	JBOX Junction Box

COMPANY		FIXTURE TYPE		DATE	
PROJECT		APPROVED BY			

Product specification subject to change without notification. REV.04.06.17





**Application:** 0-10V dimming for TruLine .5A  
**Power Supply:** PSB-96W-010-24VDC (24VDC 96W output) | PSB-2X96W-010-24VDC (24VDC 2X96W output).  
**Dimming:** Radio Ra2 (with GRX-TVI), Grafik Eye Qs (with GRX-TVI), Diva (with PP20); Nova T; Philips: Sunrise SR1200ZTUNV; Leviton: IP710-LF.

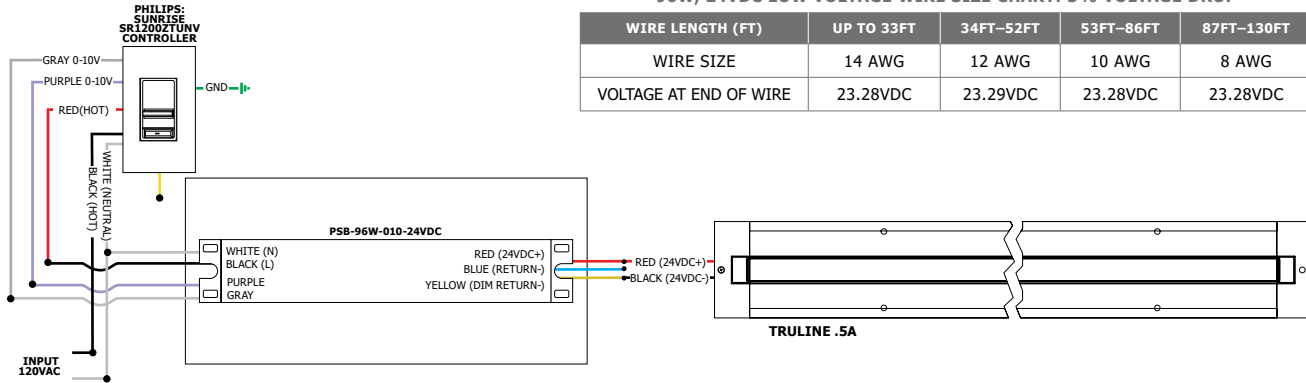

**96W, 24VDC LOW VOLTAGE WIRE SIZE CHART: 3% VOLTAGE DROP**

WIRE LENGTH (FT)	UP TO 33FT	34FT-52FT	53FT-86FT	87FT-130FT
WIRE SIZE	14 AWG	12 AWG	10 AWG	8 AWG
VOLTAGE AT END OF WIRE	23.28VDC	23.29VDC	23.28VDC	23.28VDC

**2.5 WATTS PER FOOT - 22K, 27K, 30K, 35K, 40K AND 57K WHITE LEDS**

LENGTH IN FEET	WATTS	LENGTH IN FEET	WATTS	LENGTH IN FEET	WATTS	LENGTH IN FEET	WATTS
1	3	11	27	21	51	31	75
2	5	12	29	22	54	32	78
3	8	13	32	23	56	33	80
4	10	14	34	24	58	34	82
5	13	15	37	25	61	35	85
6	15	16	39	26	63	36	87
7	17	17	41	27	66	37	90
8	20	18	44	28	68	38	92
9	22	19	46	29	70	39	94
10	24	20	48	30	72	40	96

**5 WATTS PER FOOT - 22K, 27K, 27D, 30K, 30D, 35K, 40K, 57K, 2K4K AND RGB LEDS**

LENGTH IN FEET	WATTS	LENGTH IN FEET	WATTS	LENGTH IN FEET	WATTS	LENGTH IN FEET	WATTS
1	5	6	30	11	54	16	78
2	10	7	34	12	58	17	82
3	16	8	40	13	64	18	88
4	20	9	44	14	68	19	92
5	24	10	48	15	72	20	96

**6 WATTS PER FOOT - RGBW LEDS**

LENGTH IN FEET	WATTS	LENGTH IN FEET	WATTS	LENGTH IN FEET	WATTS	LENGTH IN FEET	WATTS
1	6	5	30	9	54	13	78
2	12	6	36	10	60	14	84
3	18	7	42	11	66	15	90
4	24	8	48	12	72	16	96

COMPANY		FIXTURE TYPE		DATE	
PROJECT		APPROVED BY			

Product specification subject to change without notification. REV.04.06.17

A Division of PureEdge Lighting 1718 W. Fullerton Chicago, IL 60614 • Ph: 773.770.1196 • Fax: 773.883.6128 • www.purelighting.com





**TM-30-15 DATA:** The data below is for SS2C, SS5C, SS7C, and SS10C bare LED Soft Strips. Consistent color temperatures throughout a single strip and among multiple strips is possible through a 3 phase binning process in which each order is inspected with a color meter to ensure uniformity.

**2200K** | Rf: 83.9 | Rg: 94.9

COLOR VECTOR GRAPHIC

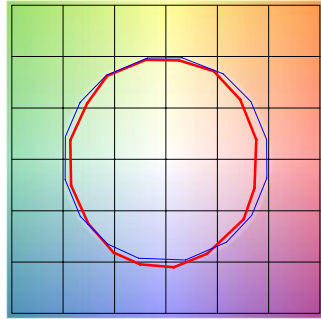

■ Test ■ Reference

HUE BIN	Rf	GRAPHIC SHIFTS %	
		CHROMA	HUE
1	77.6	-10.0%	1.8%
2	80.7	-7.5%	7.0%
3	79.5	-2.9%	8.9%
4	90.5	-3.1%	2.4%
5	93.9	-1.3%	1.9%
6	91.9	-0.9%	-0.2%
7	87.6	-6.3%	-2.7%
8	90.5	-5.4%	2.7%
9	83.8	-4.7%	6.5%
10	81.2	-2.5%	10.0%
11	83.3	3.9%	9.4%
12	86.4	5.6%	2.6%
13	86.2	4.5%	-12.4%
14	64.3	-1.0%	-21.9%
15	85.1	-4.4%	-7.5%
16	75.0	-9.9%	-12.0%

**2700K** | Rf: 87.7 | Rg: 96.1

COLOR VECTOR GRAPHIC

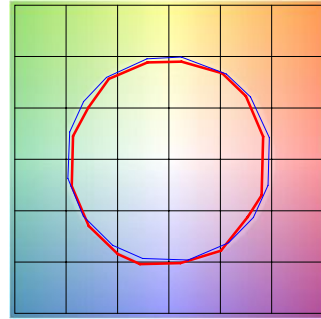

■ Test ■ Reference

HUE BIN	Rf	GRAPHIC SHIFTS %	
		CHROMA	HUE
1	86.4	-5.6%	2.3%
2	89.7	-3.3%	3.1%
3	90.5	-1.5%	3.8%
4	90.0	-4.3%	1.1%
5	92.9	-3.7%	0.2%
6	93.5	-2.5%	-0.8%
7	86.3	-7.2%	2.5%
8	90.7	-4.0%	3.2%
9	85.2	-2.4%	8.1%
10	81.7	0.9%	10.8%
11	85.4	4.5%	8.9%
12	88.7	5.7%	-1.4%
13	88.3	1.3%	-7.9%
14	85.1	2.4%	-10.4%
15	88.1	-4.8%	-2.7%
16	81.7	-4.3%	-10.9%

**3000K** | Rf: 88.1 | Rg: 99.7

COLOR VECTOR GRAPHIC

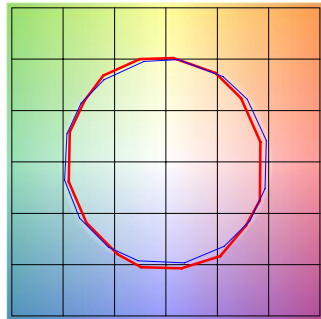

■ Test ■ Reference

HUE BIN	Rf	GRAPHIC SHIFTS %	
		CHROMA	HUE
1	87.7	-5.9%	-0.3%
2	87.9	-4.4%	4.3%
3	82.9	-1.2%	7.9%
4	89.9	0.6%	4.7%
5	92.7	3.0%	3.5%
6	92.7	3.6%	-1.7%
7	90.8	-1.3%	-4.4%
8	93.7	-2.5%	-2.2%
9	91.7	-3.7%	2.3%
10	85.5	-2.8%	7.8%
11	83.3	0.7%	11.0%
12	86.4	5.5%	3.8%
13	90.6	4.6%	-3.6%
14	85.6	5.9%	-8.4%
15	89.5	-0.6%	-5.7%
16	82.6	-2.7%	-12.0%

**3500K** | Rf: 86.1 | Rg: 95.5

COLOR VECTOR GRAPHIC

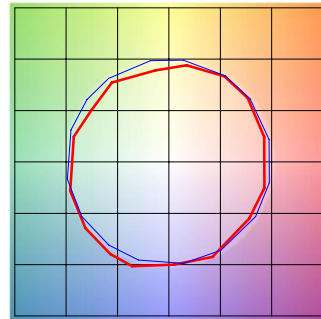

■ Test ■ Reference

HUE BIN	Rf	GRAPHIC SHIFTS %	
		CHROMA	HUE
1	86.6	-4.2%	3.4%
2	91.7	-1.4%	1.8%
3	94.9	-0.7%	0.4%
4	87.9	-4.5%	-4.1%
5	85.9	-10.3%	-2.7%
6	89.8	-5.2%	-0.4%
7	79.6	-9.5%	6.5%
8	87.6	-4.0%	5.7%
9	81.4	-0.5%	11.8%
10	78.3	3.3%	11.4%
11	85.7	6.3%	6.1%
12	86.3	7.1%	-4.6%
13	86.1	-0.7%	-9.6%
14	85.1	0.8%	-10.4%
15	83.4	-4.1%	-5.3%
16	82.5	-3.6%	-5.7%

**4000K** | Rf: 87.6 | Rg: 96.8

COLOR VECTOR GRAPHIC

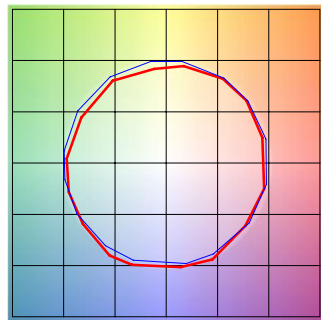

■ Test ■ Reference

HUE BIN	Rf	GRAPHIC SHIFTS %	
		CHROMA	HUE
1	89.0	-3.1%	2.1%
2	93.2	-0.9%	1.3%
3	94.3	-1.1%	0.7%
4	89.5	-4.0%	-2.3%
5	87.6	-7.8%	-1.8%
6	92.2	-4.6%	0.1%
7	87.4	-6.6%	3.6%
8	85.7	-3.8%	7.0%
9	81.5	-1.3%	12.4%
10	80.0	0.9%	11.4%
11	83.3	5.9%	8.7%
12	89.7	4.8%	-0.3%
13	88.5	2.4%	-6.3%
14	92.7	4.0%	-3.8%
15	86.1	-1.6%	-4.5%
16	85.0	-1.4%	-5.0%

**5700K** | Rf: 80.3 | Rg: 91.5

COLOR VECTOR GRAPHIC

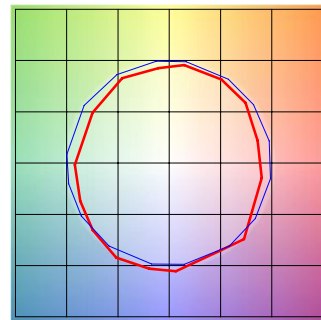

■ Test ■ Reference

HUE BIN	Rf	GRAPHIC SHIFTS %	
		CHROMA	HUE
1	73.8	-11.2%	2.6%
2	83.7	-5.5%	5.8%
3	84.2	-4.0%	5.5%
4	85.8	-3.5%	1.3%
5	85.3	-7.1%	0.6%
6	89.2	-5.8%	-2.2%
7	81.5	-10.7%	1.2%
8	75.7	-9.7%	8.5%
9	74.9	-7.8%	18.8%
10	67.8	-1.6%	18.0%
11	76.1	5.5%	12.0%
12	90.8	4.9%	-1.6%
13	83.6	5.0%	-9.5%
14	81.7	-1.2%	-10.0%
15	69.0	2.0%	-22.8%
16	83.2	-8.5%	-1.0%

A Division of PureEdge Lighting 1718 W. Fullerton Chicago, IL 60614 • Ph: 773.770.1196 • Fax: 773.883.6128 • www.purelighting.com



COMPANY		FIXTURE TYPE		DATE	
PROJECT		APPROVED BY			



**TM-30-15 DATA:** The data below is for SS2C, SS5C, SS7C, and SS10C bare LED Soft Strips. Consistent color temperatures throughout a single strip and among multiple strips is possible through a 3 phase binning process in which each order is inspected with a color meter to ensure uniformity.

**2700D** | Rf: 89.5 | Rg: 100.8

COLOR VECTOR GRAPHIC

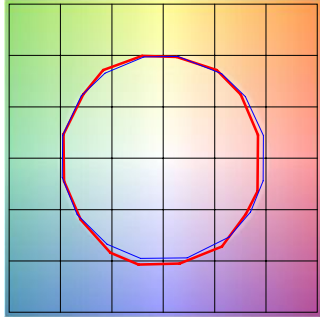

■ Test ■ Reference

HUE BIN	Rf	GRAPHIC SHIFTS %	
		CHROMA	HUE
1	88.8	-5.1%	1.4%
2	89.8	-2.7%	4.1%
3	87.2	0.3%	5.9%
4	92.3	-0.9%	1.0%
5	93.3	1.5%	1.7%
6	92.4	3.6%	-0.2%
7	92.2	-0.9%	-2.4%
8	96.7	-0.4%	-1.1%
9	92.3	-1.2%	3.7%
10	88.9	-0.0%	6.1%
11	86.4	5.1%	7.4%
12	88.2	6.3%	-0.9%
13	87.2	3.8%	-8.1%
14	84.2	3.8%	-11.0%
15	89.8	-2.6%	-4.3%
16	82.7	-3.4%	-11.1%

**3000D** | Rf: 89.8 | Rg: 101.4

COLOR VECTOR GRAPHIC

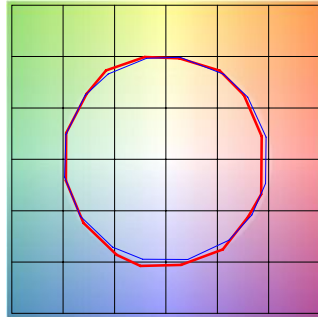

■ Test ■ Reference

HUE BIN	Rf	GRAPHIC SHIFTS %	
		CHROMA	HUE
1	90.2	-4.2%	1.5%
2	90.9	-2.0%	3.7%
3	87.9	0.8%	5.5%
4	92.1	-0.9%	0.6%
5	93.0	1.5%	1.6%
6	92.2	3.9%	-0.2%
7	92.1	-0.3%	-2.0%
8	96.7	0.0%	-1.2%
9	92.5	-0.6%	3.7%
10	88.3	1.1%	7.0%
11	87.2	4.1%	7.4%
12	87.2	6.7%	-1.0%
13	88.2	3.8%	-7.2%
14	85.3	4.3%	-9.9%
15	90.9	-2.2%	-3.6%
16	83.4	-2.2%	-11.2%

**2000K only (2K4K)** | Rf: 84.3 | Rg: 96.9

COLOR VECTOR GRAPHIC

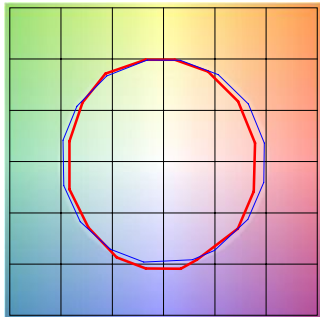

■ Test ■ Reference

HUE BIN	Rf	GRAPHIC SHIFTS %	
		CHROMA	HUE
1	80.3	-8.9%	1.7%
2	79.7	-7.0%	7.8%
3	78.9	-2.9%	10.0%
4	89.5	-0.5%	5.1%
5	94.4	0.7%	1.7%
6	92.1	2.4%	-0.3%
7	89.4	-2.4%	-5.9%
8	89.7	-6.4%	-0.2%
9	86.0	-4.9%	4.6%
10	81.8	-3.4%	9.3%
11	83.1	3.3%	9.7%
12	85.8	5.6%	3.3%
13	85.6	6.2%	-12.8%
14	61.7	-1.9%	-19.0%
15	79.7	-3.3%	-12.9%
16	78.1	-7.9%	-10.6%

**4000K only (2K4K)** | Rf: 89.6 | Rg: 99.1

COLOR VECTOR GRAPHIC

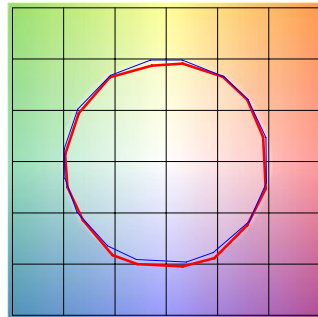

■ Test ■ Reference

HUE BIN	Rf	GRAPHIC SHIFTS %	
		CHROMA	HUE
1	91.3	-2.5%	1.0%
2	95.3	-0.5%	0.5%
3	94.3	-0.7%	1.1%
4	91.1	-3.4%	-1.1%
5	89.5	-5.6%	0.0%
6	94.6	-1.4%	1.3%
7	93.2	-3.0%	2.6%
8	91.3	-1.8%	4.6%
9	86.5	-0.9%	9.1%
10	83.3	-0.5%	9.5%
11	83.3	4.9%	9.0%
12	89.7	4.1%	1.7%
13	90.1	3.6%	-4.3%
14	93.4	5.2%	-2.1%
15	87.4	0.4%	-4.3%
16	86.6	0.4%	-6.1%

**2K4K (3000K)** | Rf: 90.2 | Rg: 101.4

COLOR VECTOR GRAPHIC

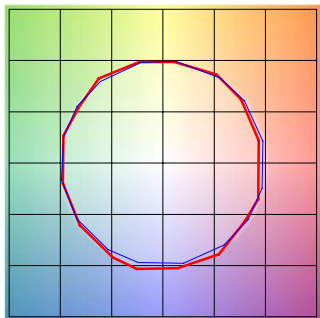

■ Test ■ Reference

HUE BIN	Rf	GRAPHIC SHIFTS %	
		CHROMA	HUE
1	90.9	-3.8%	1.3%
2	91.7	-1.9%	3.3%
3	88.7	0.7%	5.1%
4	92.4	-1.0%	0.7%
5	92.9	0.9%	1.7%
6	93.1	3.3%	-0.6%
7	91.0	-1.8%	-0.4%
8	97.0	0.2%	-1.1%
9	92.8	-0.5%	3.6%
10	88.3	1.0%	7.0%
11	87.1	3.8%	7.8%
12	87.6	6.5%	-0.3%
13	89.3	3.6%	-6.3%
14	86.1	4.5%	-9.1%
15	91.6	-1.9%	-3.1%
16	83.8	-1.5%	-11.2%



COMPANY		FIXTURE TYPE		DATE	
PROJECT		APPROVED BY			