

Mulberry Ceiling

700TDMULFM_

1.5



GENERAL PRODUCT INFORMATION:



This product is suitable for damp locations.

This product can be dimmed with a standard incandescent dimmer.

This instruction shows a typical installation.

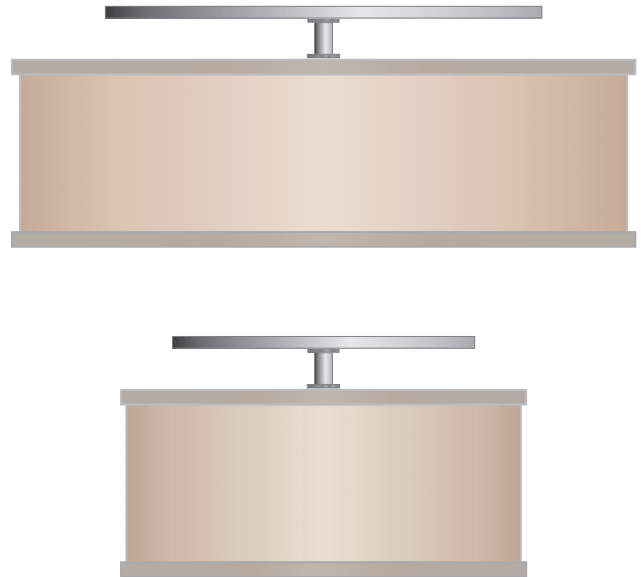

Installing the Fixture

CAUTION: To reduce the risk of a burn or electric shock during relamping, disconnect the power to the fixture.

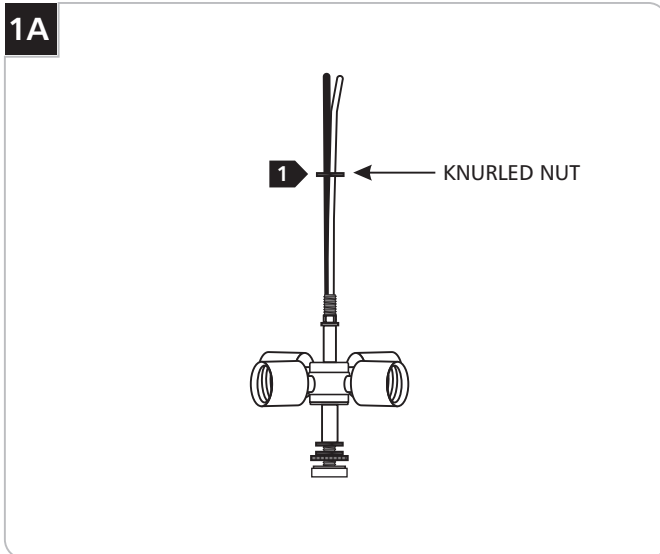

1 Unscrew and remove the knurled nut from the socket assembly.

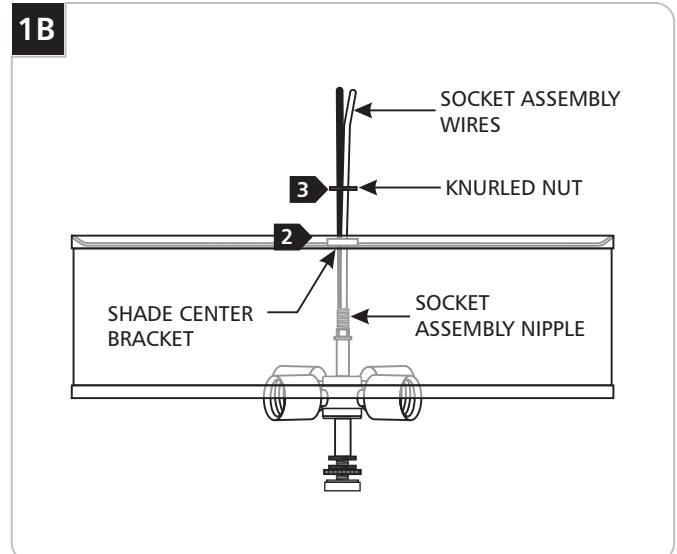

2 Feed the socket assembly wires through the shade center bracket hole and the knurled nut.

3 Tighten the knurled nut completely to the socket assembly exposed nipple.

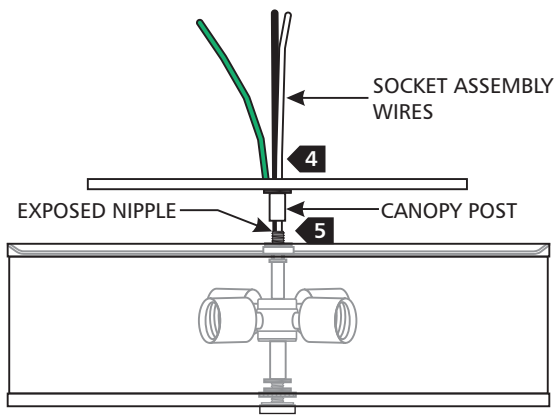
1C

- 4** Feed the socket assembly wires through the canopy post.
- 5** Rotate the canopy clockwise to tighten the canopy post completely to the exposed nipple.

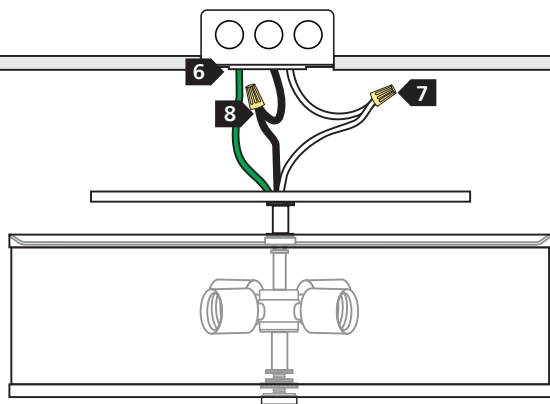
1D

NOTE: Use the provided universal round crossbar when the canopy holes do not line up with the electrical box holes.

NOTE: It is recommended that one person hold the chandelier while the electrician connects the power and installs the canopy cover.

- 6** Make sure fixture canopy is grounded in accordance with local electrical codes.
- 7** Connect the fixture white wire to the neutral power line wire with a wire nut.
- 8** Connect the fixture black wire to the hot power line wire with a wire nut.

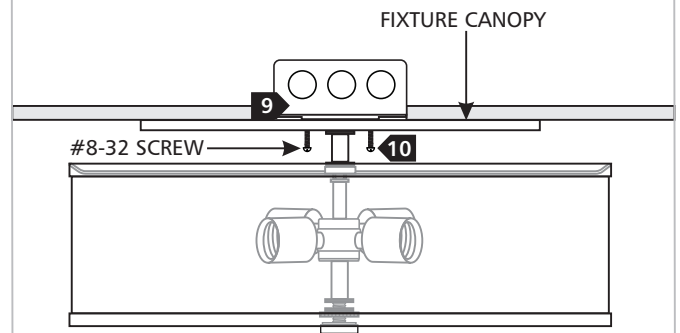
1E

- 9** Place all wires and wire nut connections inside the electrical box.
- 10** Mount the fixture canopy to the electrical box with the provided two #8-32 screws.

Installing the Lamps & Glass Disk

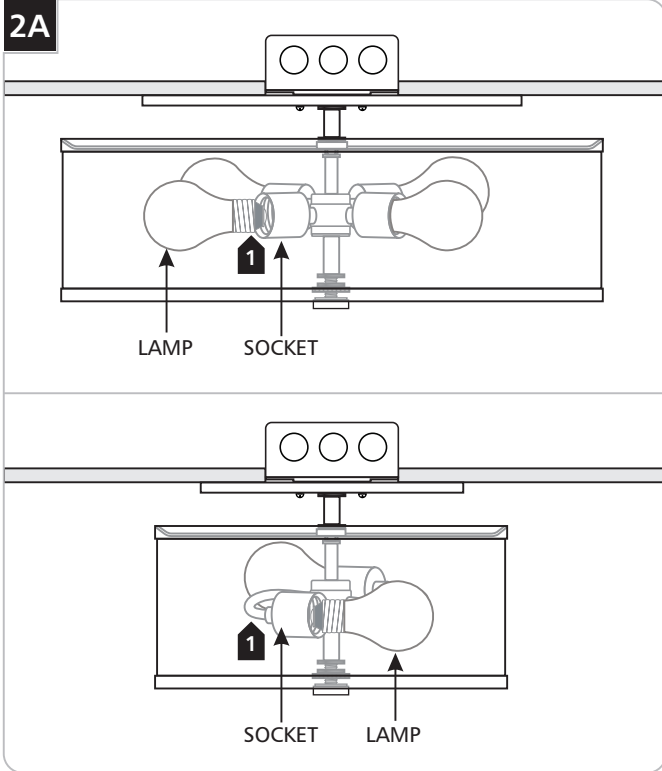

CAUTION: To reduce the risk of a burn or electric shock during relamping, disconnect the power to the fixture.

Use **MAX** 120 Volt, 75 Watt A19 (medium) base lamp with each socket.



- 1 Screw the lamps into the sockets.

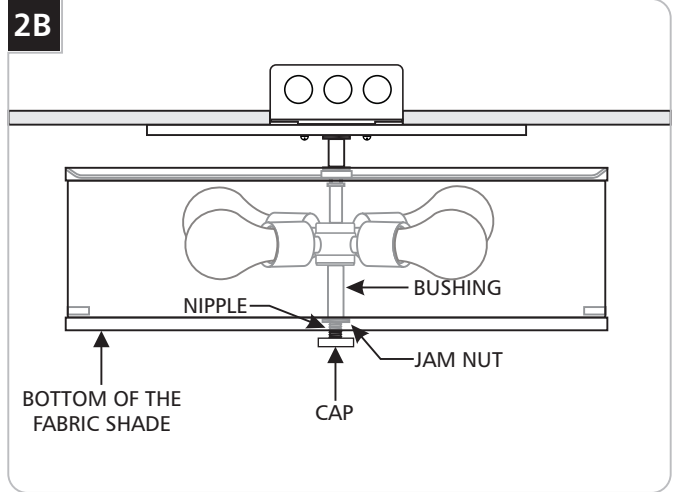

- 2 Loosen the knurled nut and adjust the nipple height so the back of the cap is level with bottom of the shade.

- 3 Tighten the jam nut firmly against the bushing.

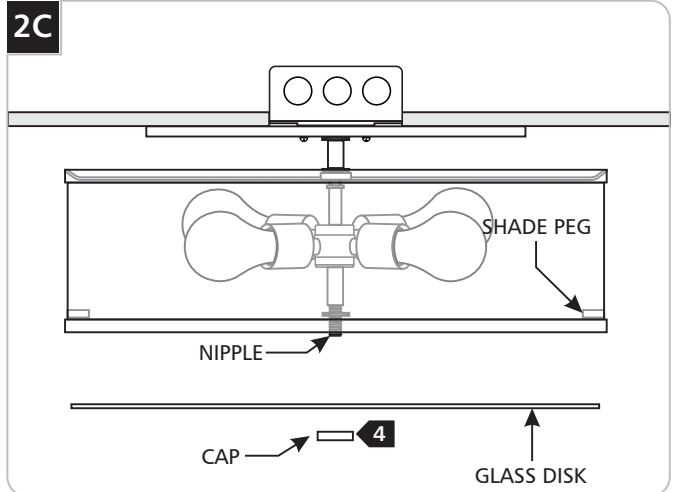

- 4 Remove the cap.

- 5 Place the glass disk onto the nipple and secure it against the shade pegs with the cap.

NOTE: Do not over tighten the cap. Overtightening may break the glass and result in injury.

SAVE THESE INSTRUCTIONS!



7400 Linder Ave, Skokie, IL 60077
847.410.4400

www.techlighting.com

© 2008 Tech Lighting, L.L.C. All rights reserved. The "Tech Lighting" graphic is a registered trademark of Tech Lighting, L.L.C. Tech Lighting reserves the right to change specifications for product improvements without notification.
A Generation Brands Company