

FreeJack Halogen Oak Park Pendant



Description:

Freejack Halogen Oak Park Pendant features a craftsman-style four-sided glass shade with Black metal frame and White inner shade. Glass available in Amber or Clear. Finish in Antique Bronze, Chrome or Satin Nickel. Includes one 50 watt, 12 volt JC GY6.35 halogen bi-pin lamp, six feet of field-cutable cable suspension (custom lengths available), and a Freejack connector. ETL Isited. 7.3 inch width x 7.3 inch depth x 3.3 inch height x 75.3 inch overall length. Canopy required if used as a monopoint, sold separately.

Shown in: Chrome / Amber

List Price: \$368.75
 Our Price: \$295.00

Shade Color: Amber
 Body Finish: Chrome
 Lamp: 1 x JC/GY6.35 (bipin)/50W/12V Halogen
 Wattage: 50W
 Dimmer: Dimmable
 Dimensions: 75.3"L x 3.3"H x 7.3"W x 7.3"D

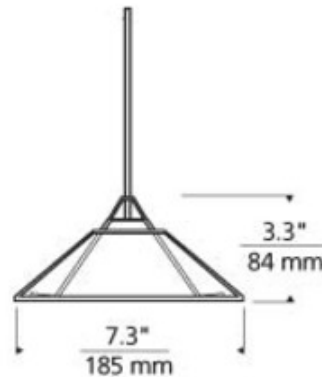

Product Number: TLG10641			
Company:		Fixture Type:	Date: Apr 19, 2018
Project:		Approved By:	

#2002FJ-OAKPARK-007H1-AMCH

Fax: (773) 883-6131

Phone: 866-954-4489

Address: 1718 W. Fullerton Ave. Chicago IL 60614

www.Lightology.com