

Monorail 300W 24V Surface Mount Transformer with FJ Port



Designer: Gregory Kay

Description:

Monorail single feed, 300 watt, 24 volt, surface mount magnetic transformer converts 120 volt input to low-voltage 24 volt output. The decorative surface mount transformer mounts to a standard 4 inch square electrical box with round plaster ring or octagon electrical box (not included). Rail attaches to one or both side-feed contacts using push-in conductive connectors (included). Standard surface mount transformer powers the rail 1 inch from ceiling. Use with 1 inch standoff's. The integral Fast Jack connector allows for installation of one Fast Jack fixture in the middle of the canopy. Maximum 300 watt load. Finish available in satin nickel, polished nickel, or antique bronze. ETL listed.



Shown in: Satin Nickel

List Price: \$779.00
Our Price: \$623.20

Shade Color: N/A
Body Finish: Satin Nickel
Lamp: N/A
Wattage: N/A
Dimmer: Low Voltage Magnetic
Dimensions: 4.15"H x 8.62"W

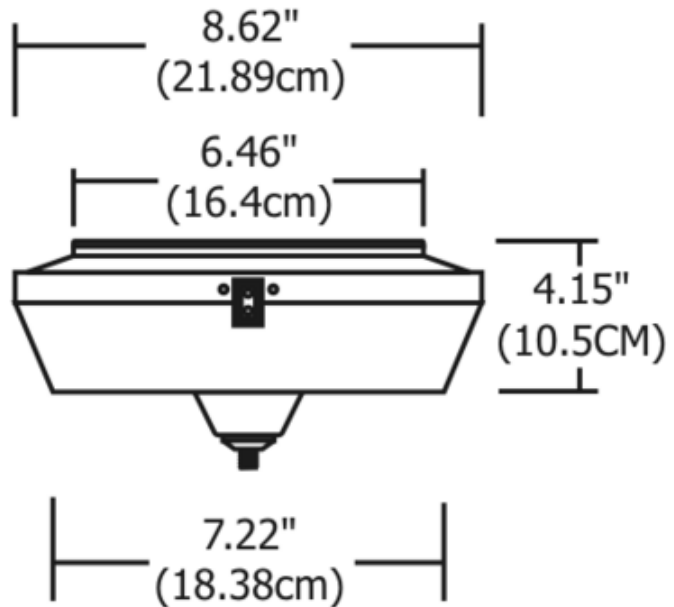

Product Number: EDG53291			
Company:		Fixture Type:	Date: Apr 26, 2018
Project:		Approved By:	

#1200MO-MAGT150-24VXX-OOSN

Fax: (773) 883-6131

Phone: 866-954-4489

Address: 1718 W. Fullerton Ave. Chicago IL 60614

www.lightology.com