

VESCA VA8332N- \_\_ \_\_ H

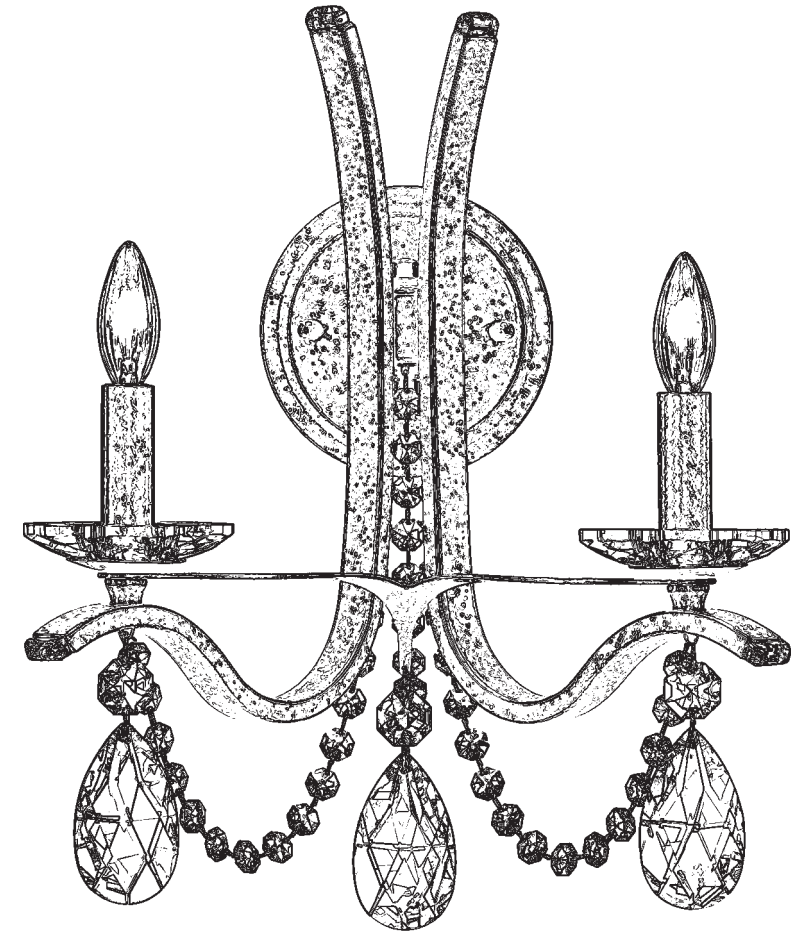











2 Lights  
Diameter: 13"  
Height: 16"  
Extension: 9"  
Hanging Weight: 4lbs.

**T**HIS DESIGN IS THE PROPRIETARY  
TRADE DRESS/TRADEMARK OF  
W SCHONBEK LLC.

 **SCHONBEK** | 1870

 **SCHONBEK** | 1870

|   |   |   |   |   |   |   |   |   |
|---|---|---|---|---|---|---|---|---|
|  |  |  |  |  |  |  |  |  |
| MAX 60 W  |   | 110-120 V   |   |  |   |   |   |   |

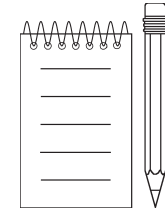
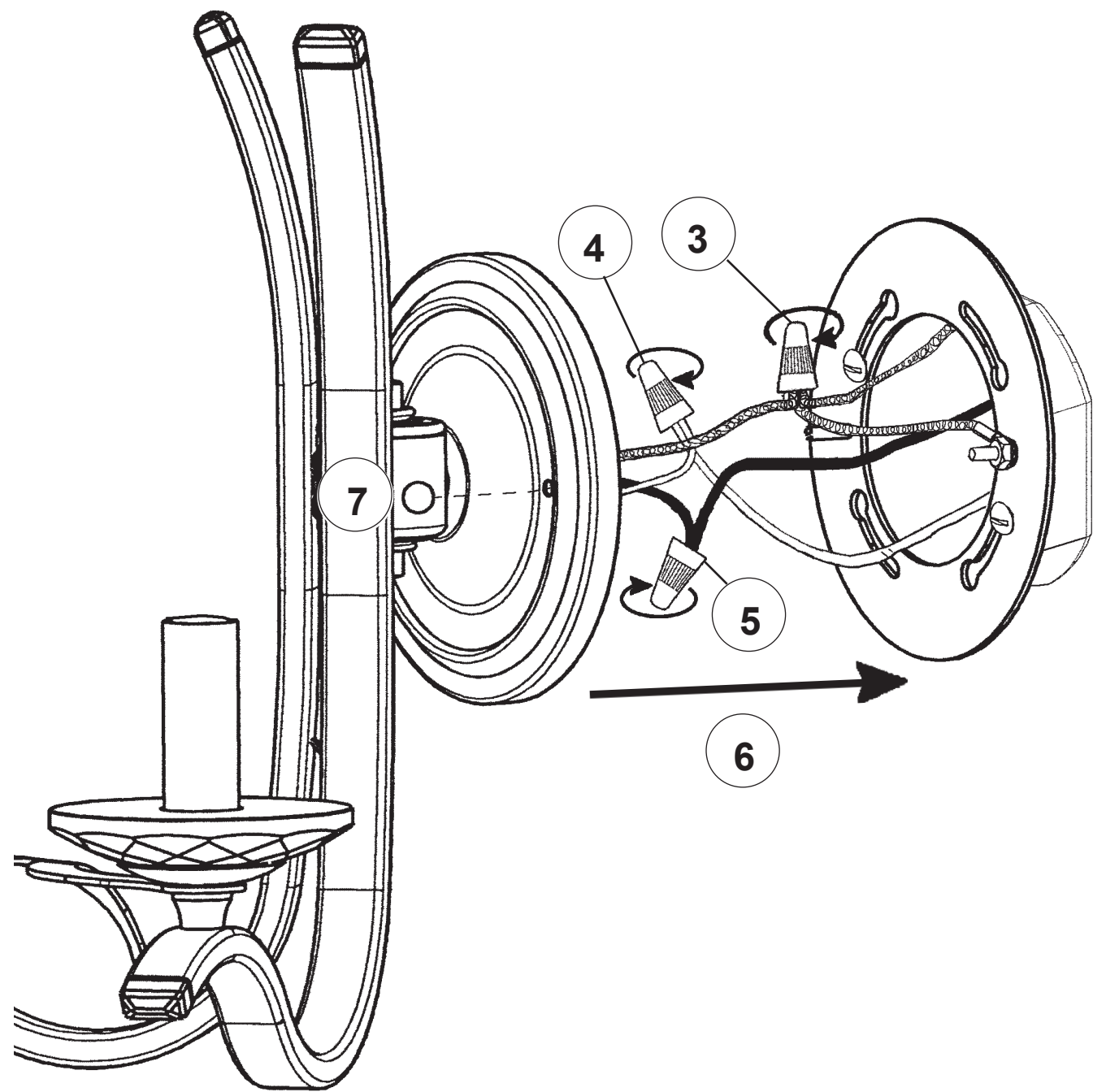
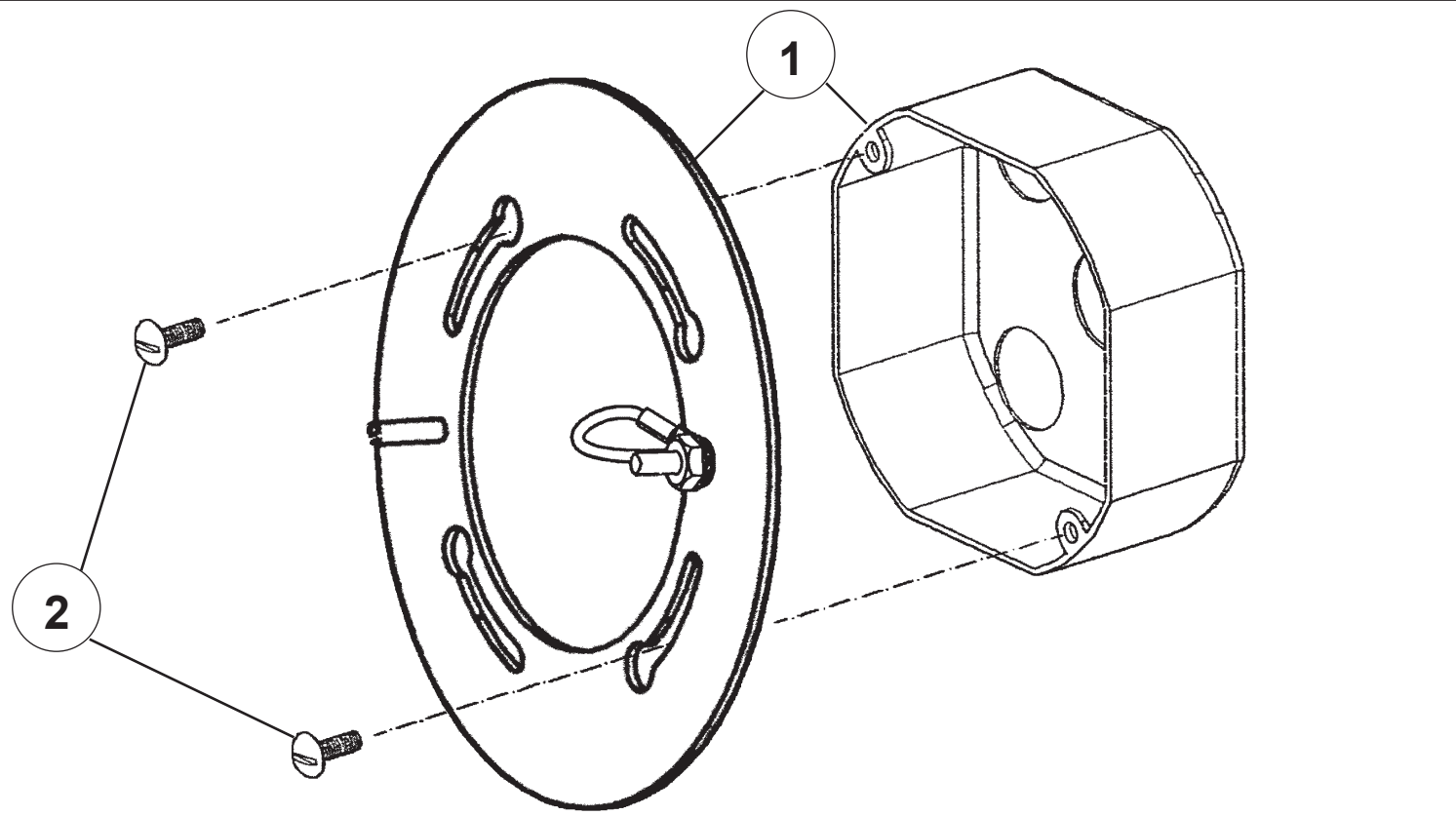

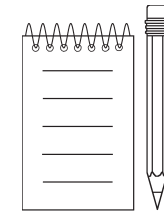
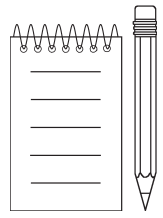

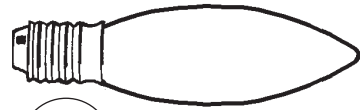

8

You will need 2 - B10  
25 Watts Recommended  
60 Watts Max

Install bulbs and be sure  
to test fixture **BEFORE**  
trimming.

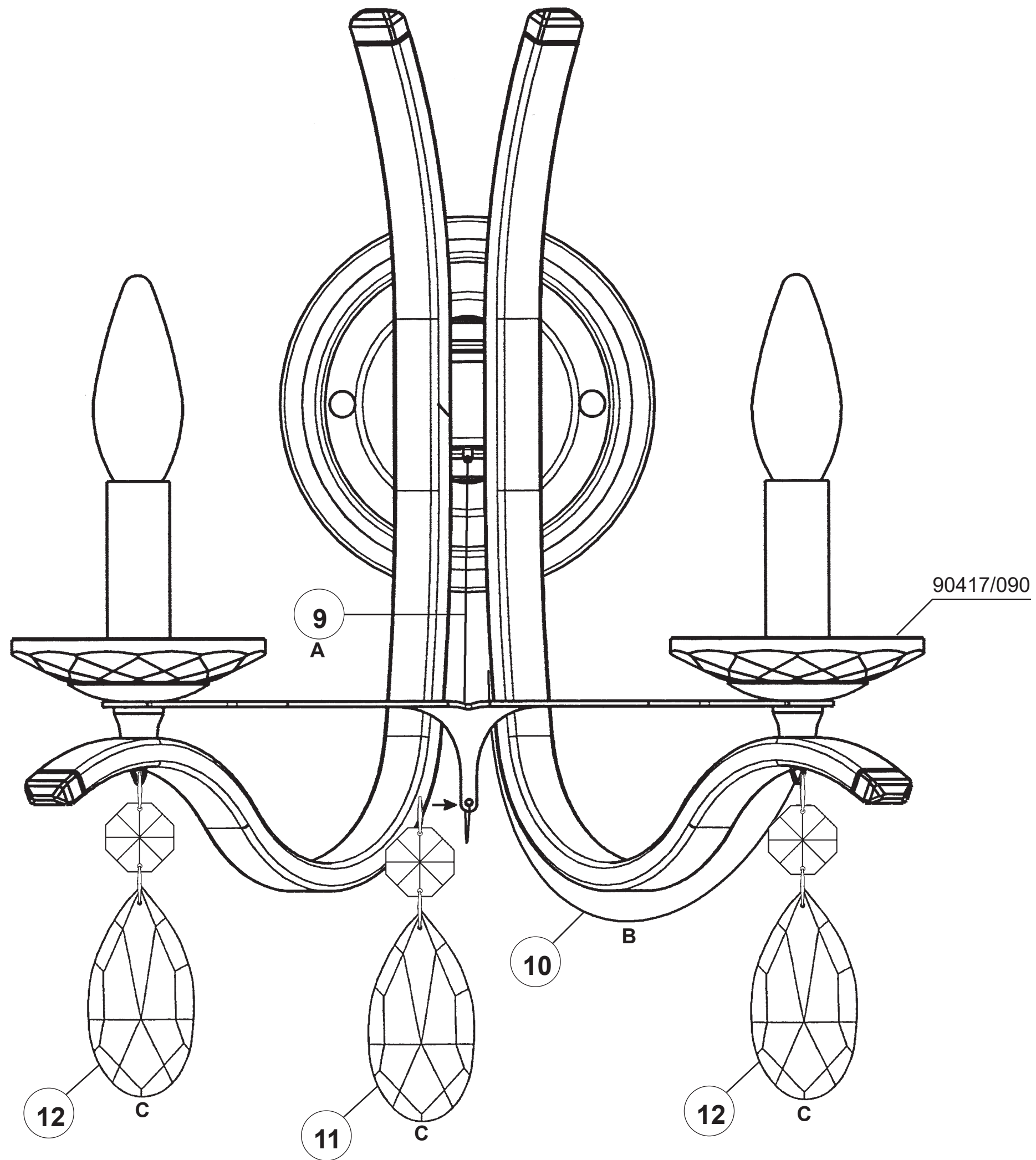

VESCA VA8332N- \_\_ \_\_R

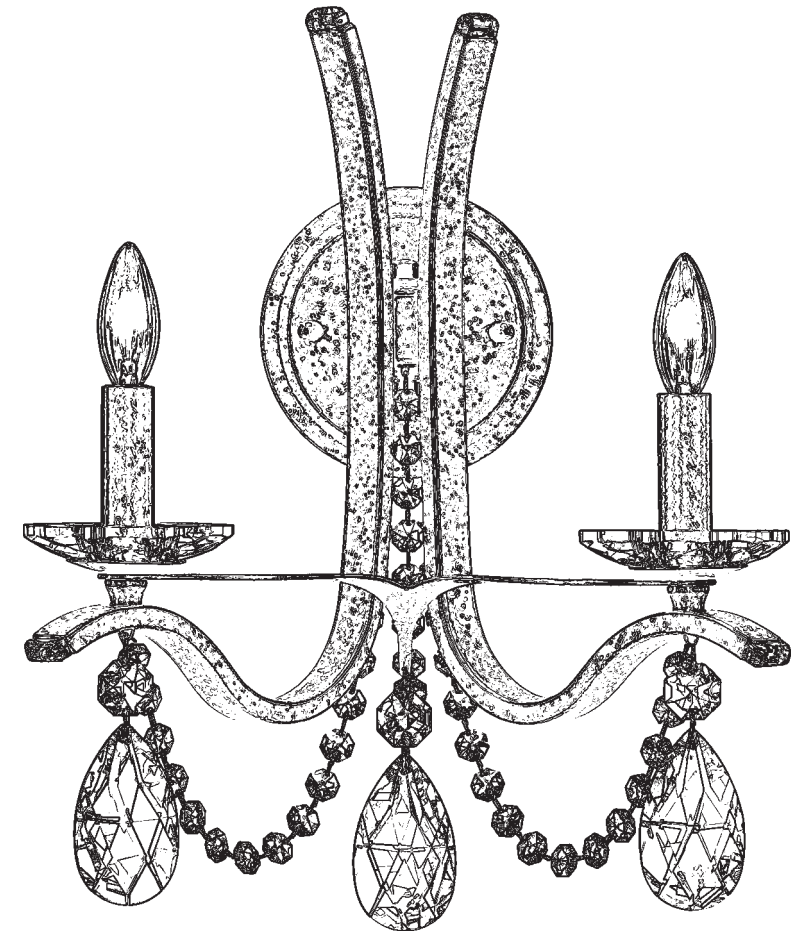











2 Lights  
Diameter: 13"  
Height: 16"  
Extension: 9"  
Hanging Weight: 4lbs.

**T**HIS DESIGN IS THE PROPRIETARY  
TRADE DRESS/TRADEMARK OF  
W SCHONBEK LLC.

 **SCHONBEK** | 1870

 **SCHONBEK** | 1870

|   |   |   |   |   |   |   |   |   |
|---|---|---|---|---|---|---|---|---|
|  |  |  |  |  |  |  |  |  |
| MAX 60 W  |   | 110-120 V   |   |  |   |   |   |   |

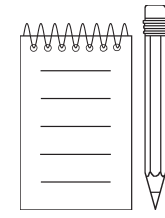
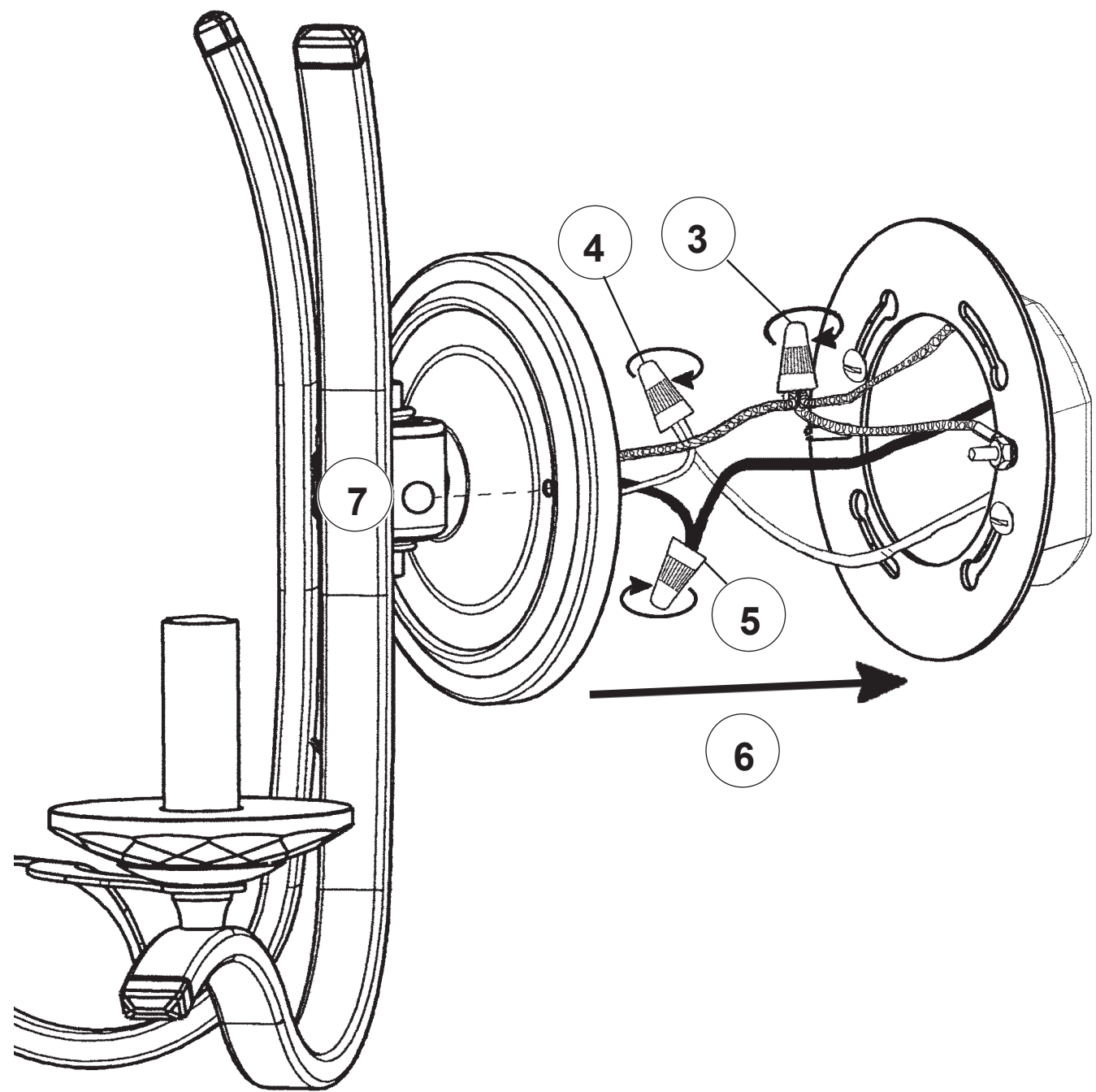
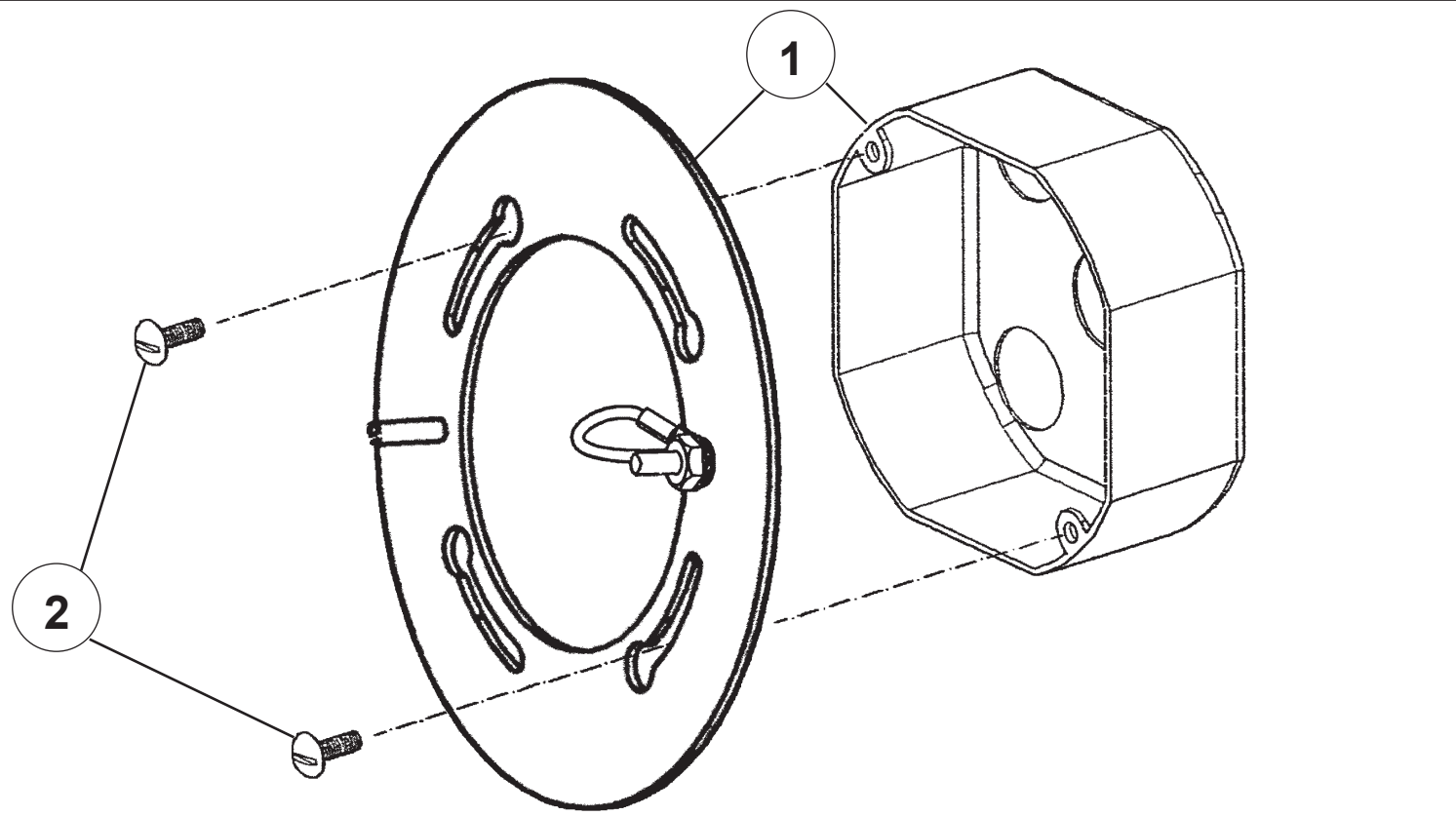

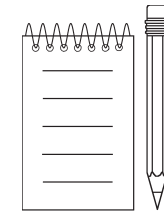
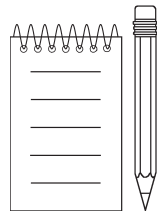

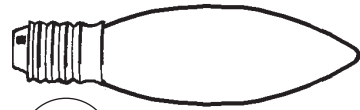

8

You will need 2 - B10  
25 Watts Recommended  
60 Watts Max

Install bulbs and be sure  
to test fixture **BEFORE**  
trimming.

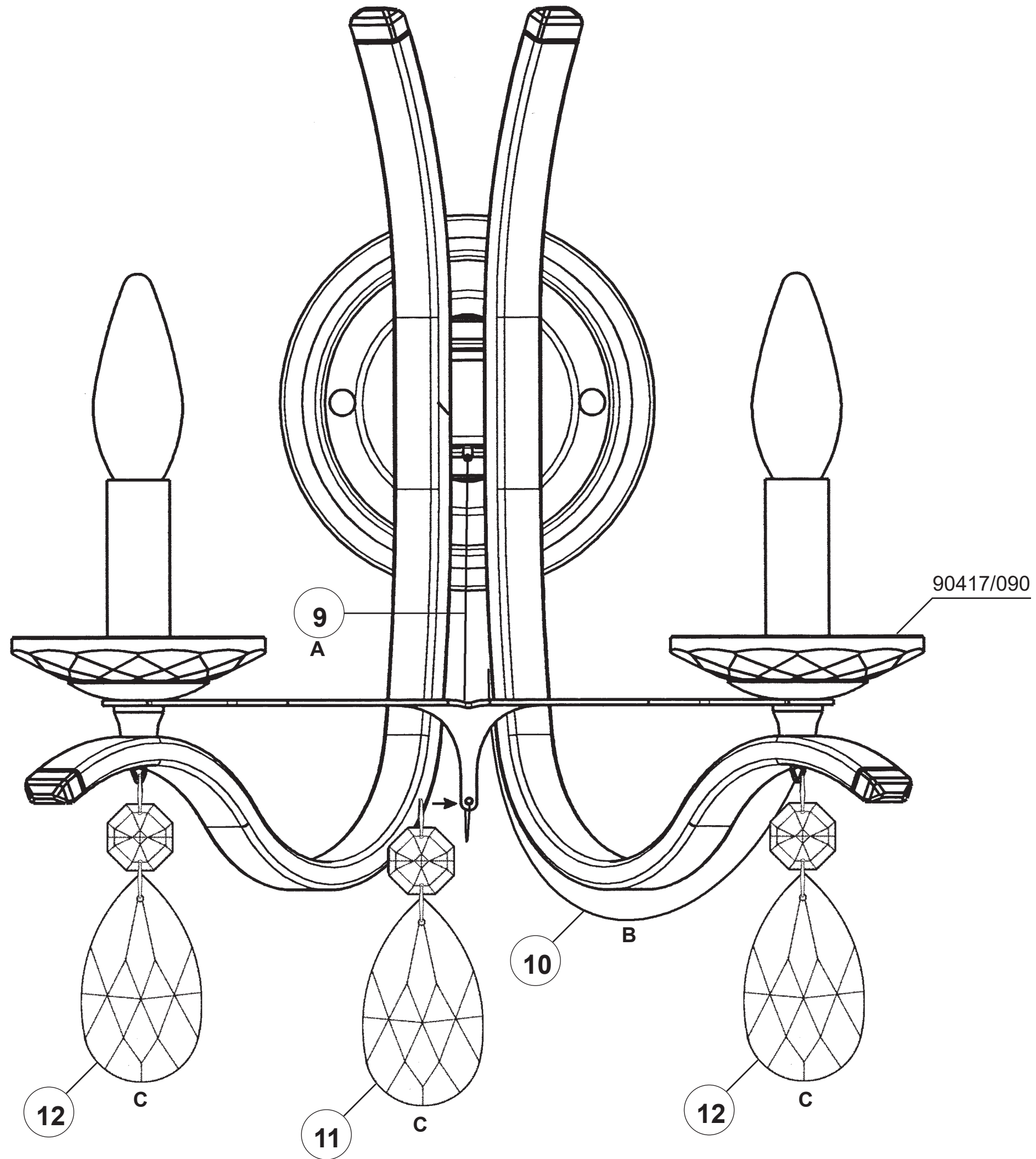



VESCA VA8332N- \_\_ \_\_ S

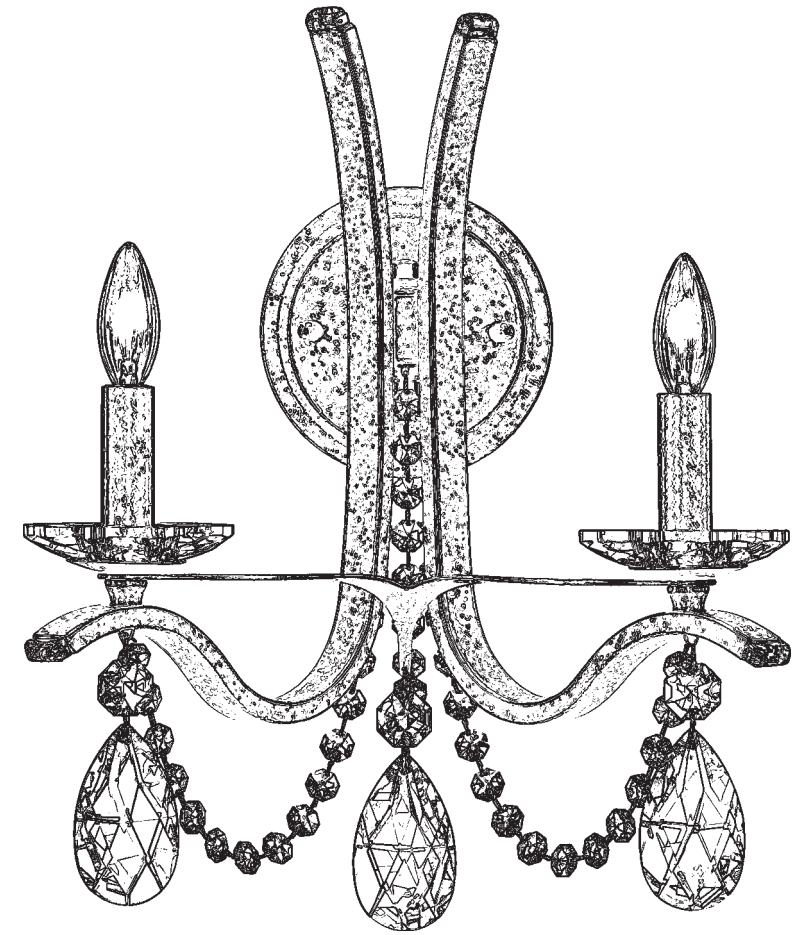











2 Lights  
Diameter: 13"  
Height: 16"  
Extension: 9"  
Hanging Weight: 4lbs.

**T**HIS DESIGN IS THE PROPRIETARY  
TRADE DRESS/TRADEMARK OF  
W SCHONBEK LLC.

 **SCHONBEK** | 1870

 **SCHONBEK** | 1870

|   |   |   |   |   |   |   |   |   |
|---|---|---|---|---|---|---|---|---|
|  |  |  |  |  |  |  |  |  |
| MAX 60 W  |   | 110-120 V   |   |  |   |   |   |   |

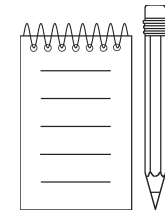
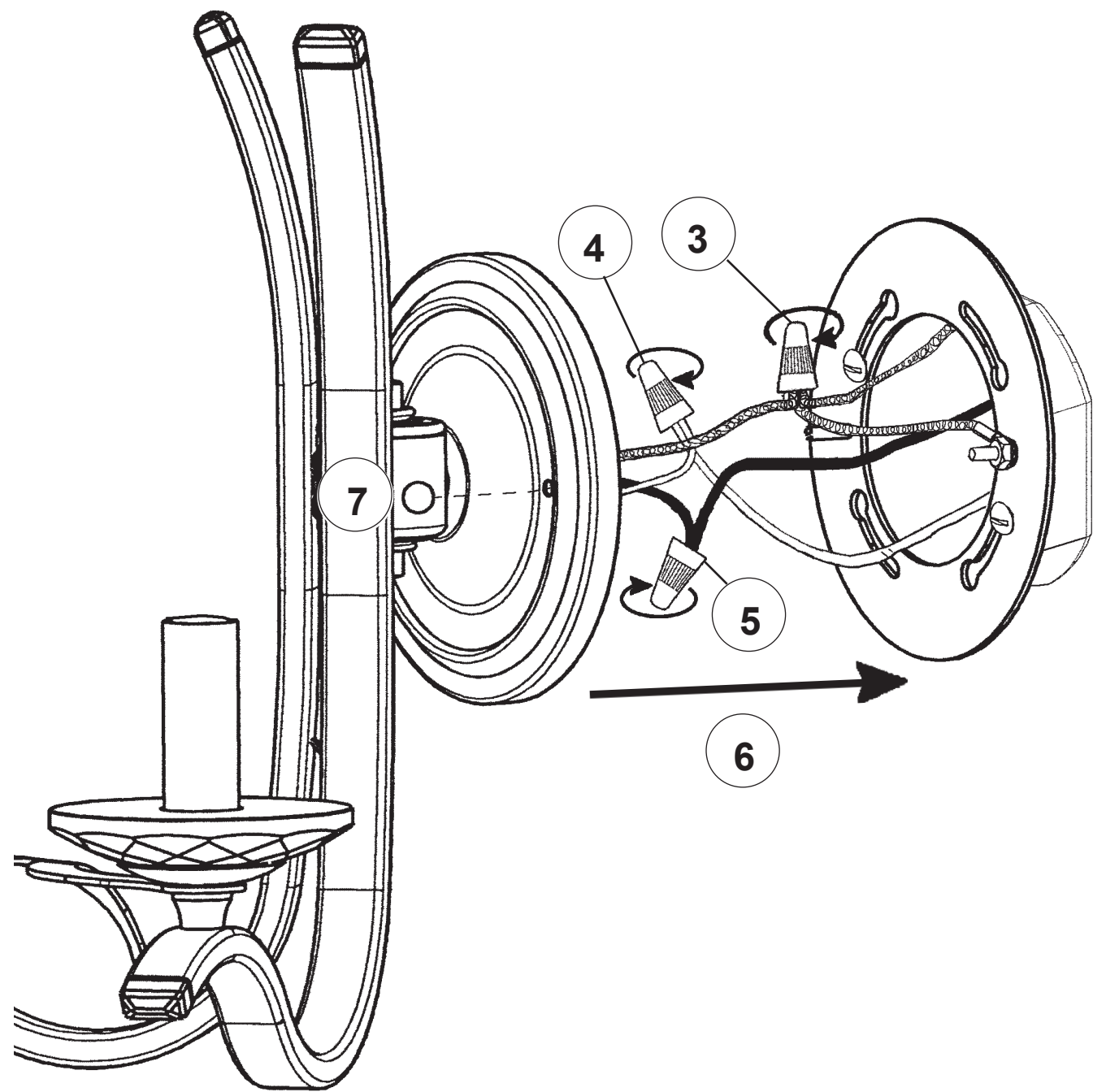
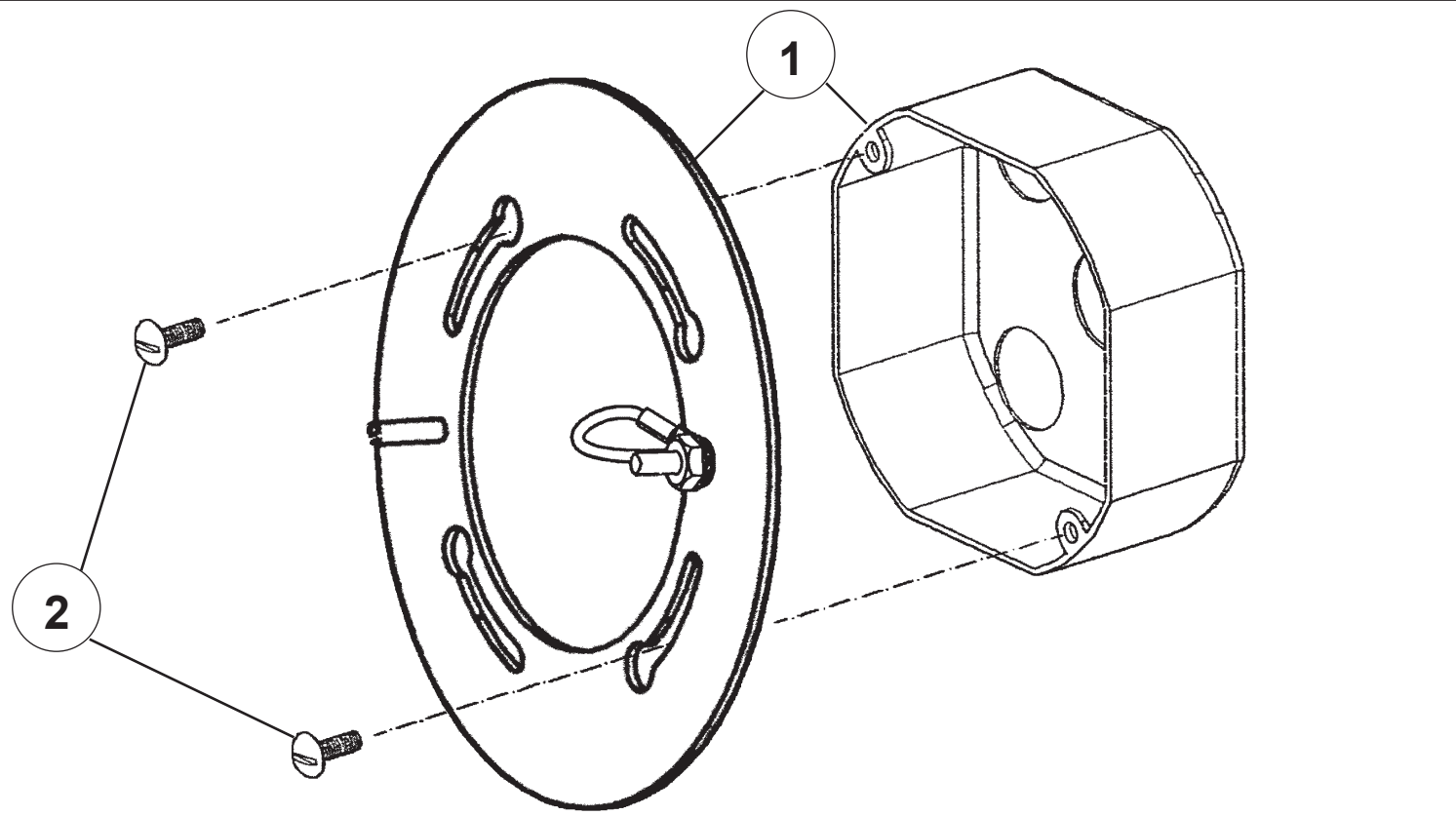

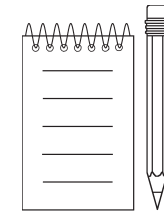
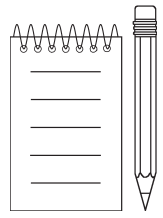

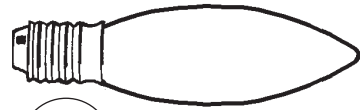

8

You will need 2 - B10  
25 Watts Recommended  
60 Watts Max

Install bulbs and be sure  
to test fixture **BEFORE**  
trimming.

