

VESCA VA8322N- \_\_ \_\_ H

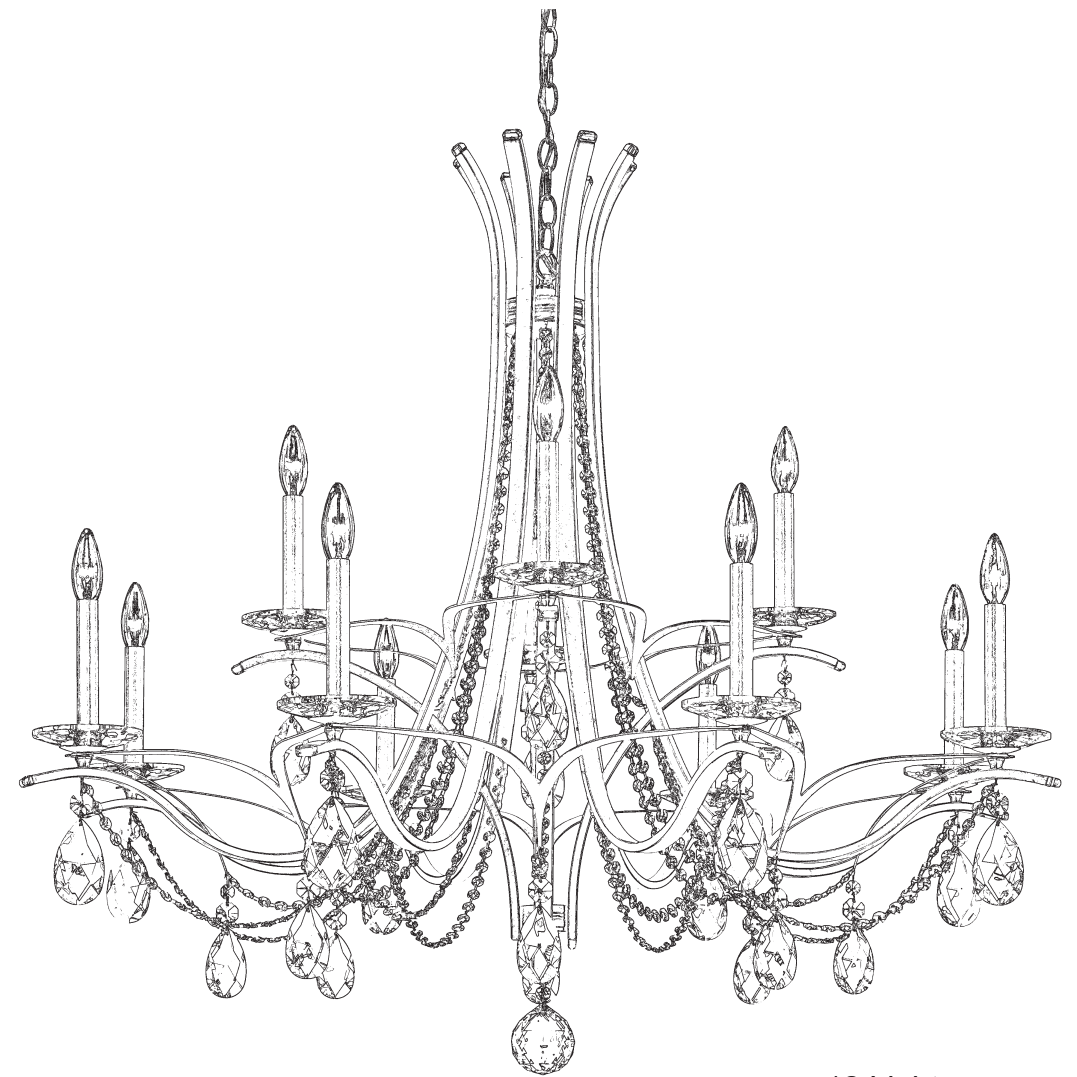











12 Lights  
Diameter: 45"  
Height: 40"  
Hanging Weight: 38lbs.

**T**HIS DESIGN IS THE PROPRIETARY  
TRADE DRESS/TRADEMARK OF  
W SCHONBEK LLC

 **SCHONBEK** | 1870

 **SCHONBEK** | 1870

								
MAX <u>60</u> W	110-120 V							

**WARNING:**

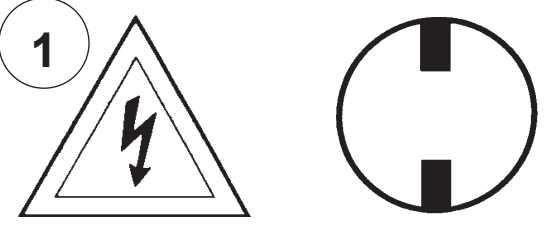
1 

**Electrical Danger Turn Power Off**

All electrical components must be installed by a licensed electrician in accordance with the National Electric Code and the appropriate local electrical codes.

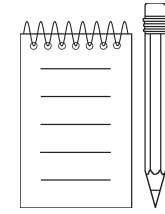
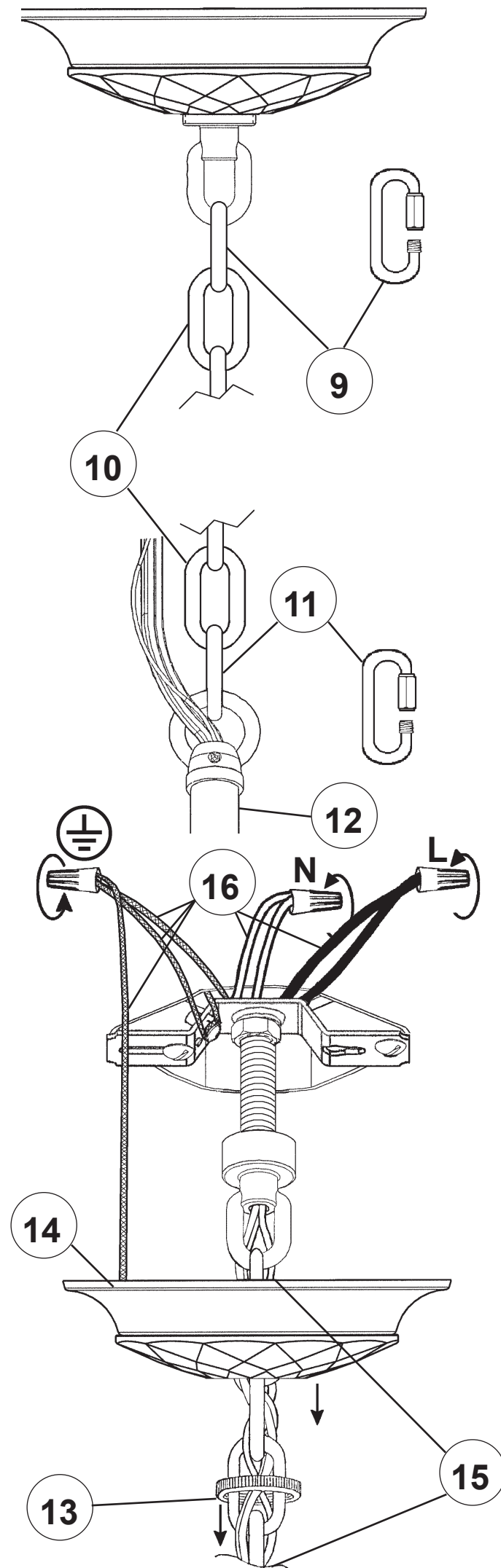
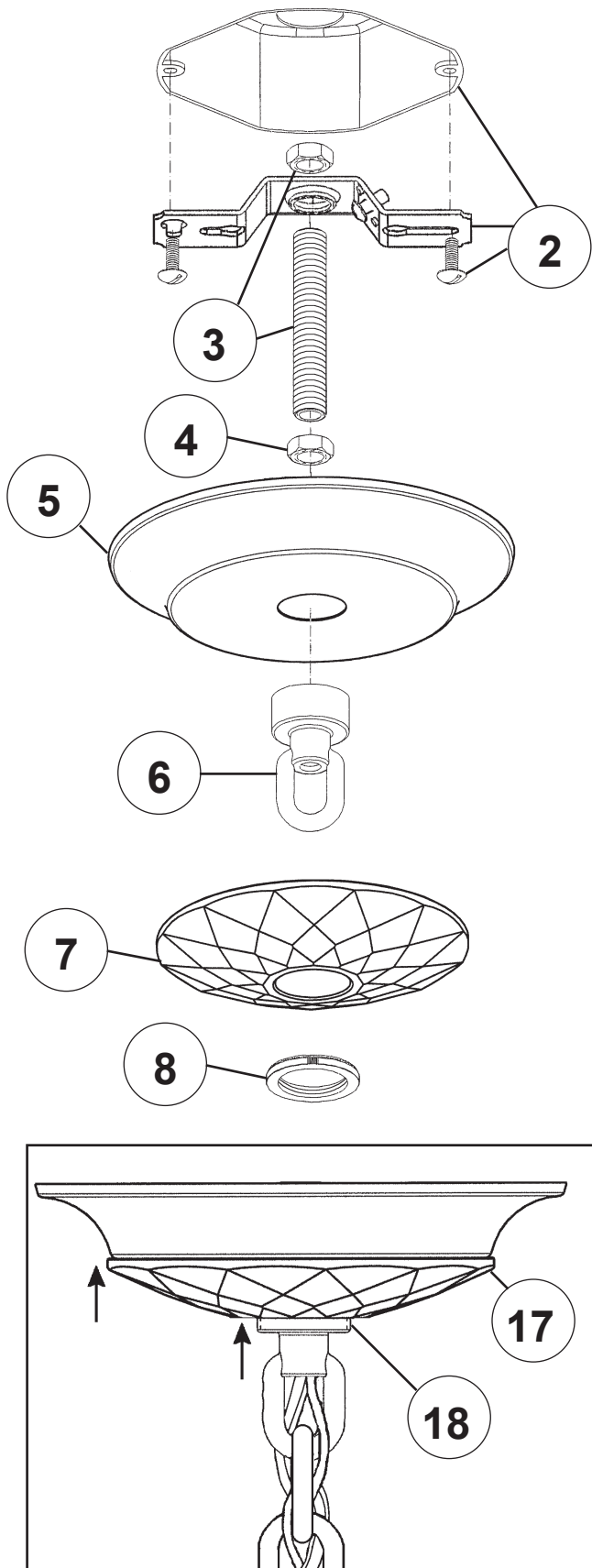

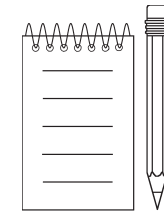

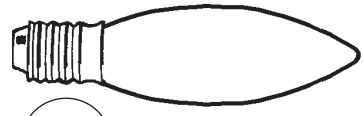

19

You will need 12 - B10  
25 Watts Recommended  
60 Watts Max

Install bulbs and be sure  
to test fixture **BEFORE**  
trimming.

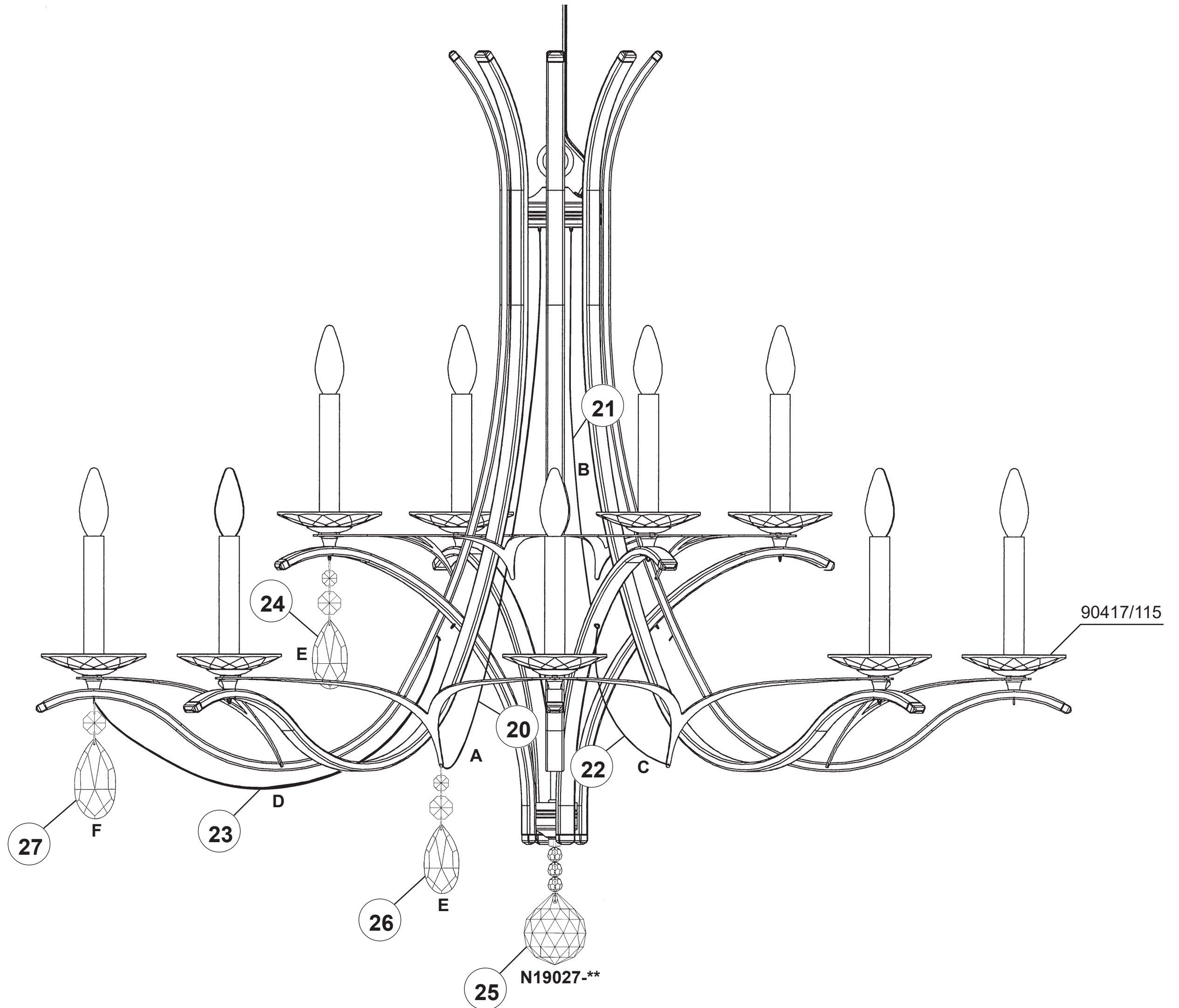

VESCA VA8322N- \_\_ \_\_ R

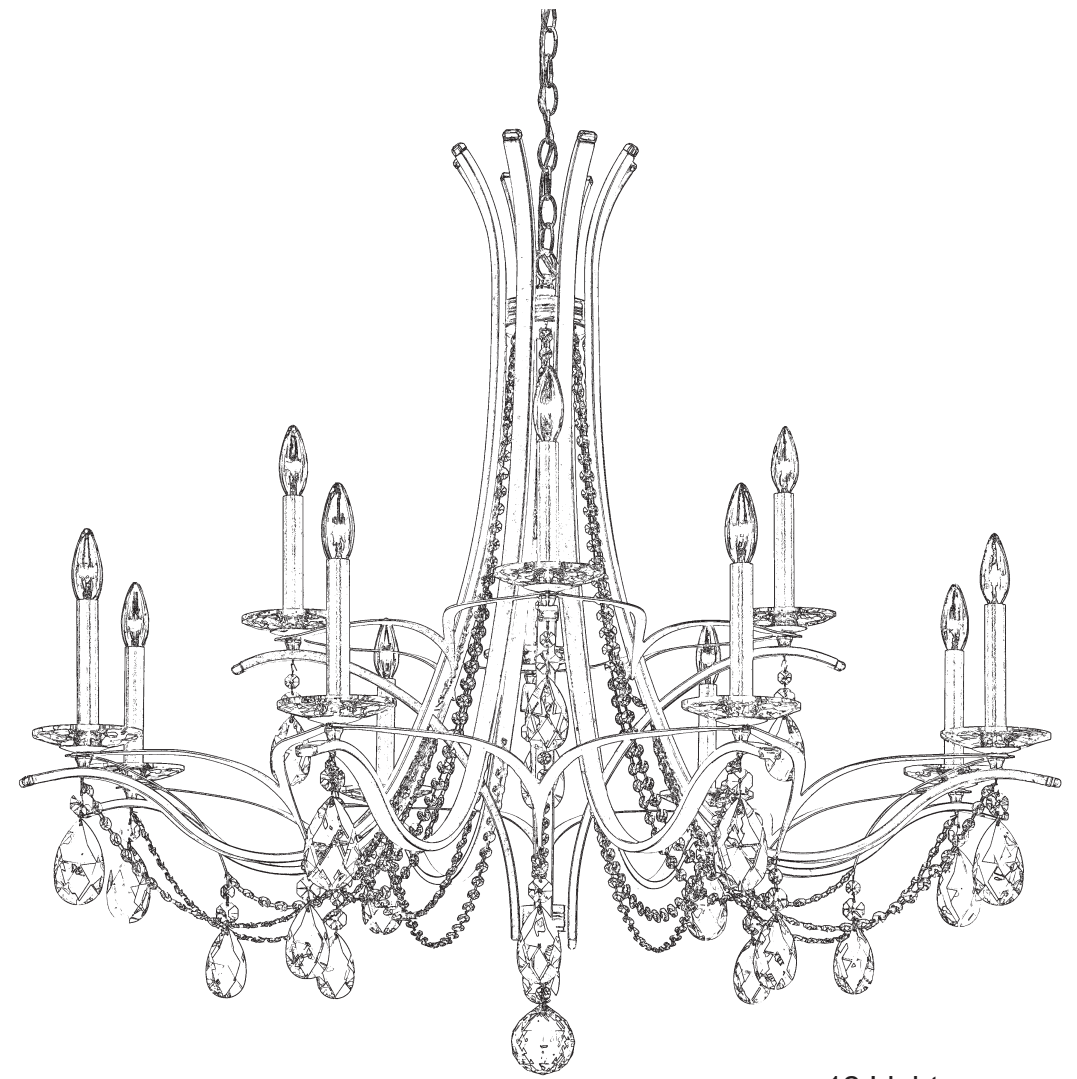











12 Lights  
Diameter: 45"  
Height: 40"  
Hanging Weight: 38lbs.

**T**HIS DESIGN IS THE PROPRIETARY  
TRADE DRESS/TRADEMARK OF  
W SCHONBEK LLC.

 **SCHONBEK** | 1870

 **SCHONBEK** | 1870

								
MAX <u>60</u> W	110-120 V							

**WARNING:**

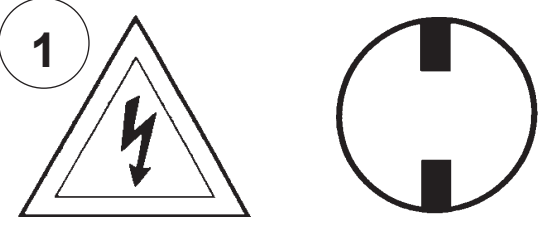
1 

**Electrical Danger Turn Power Off**

All electrical components must be installed by a licensed electrician in accordance with the National Electric Code and the appropriate local electrical codes.

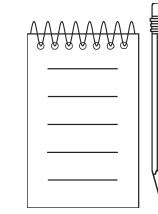
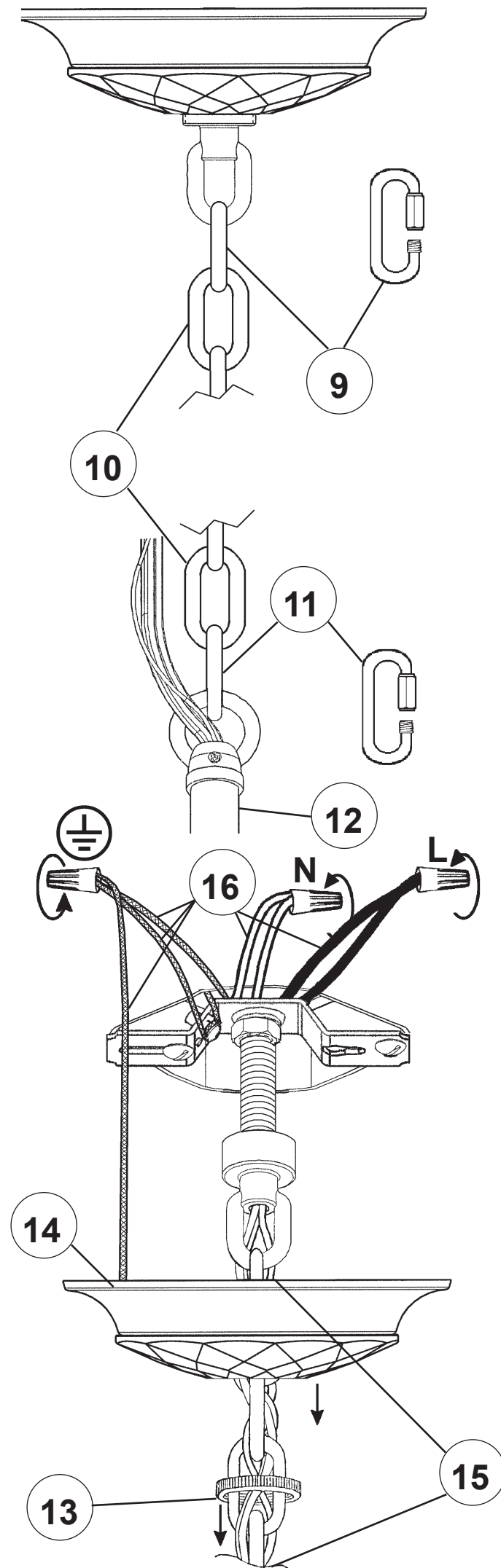
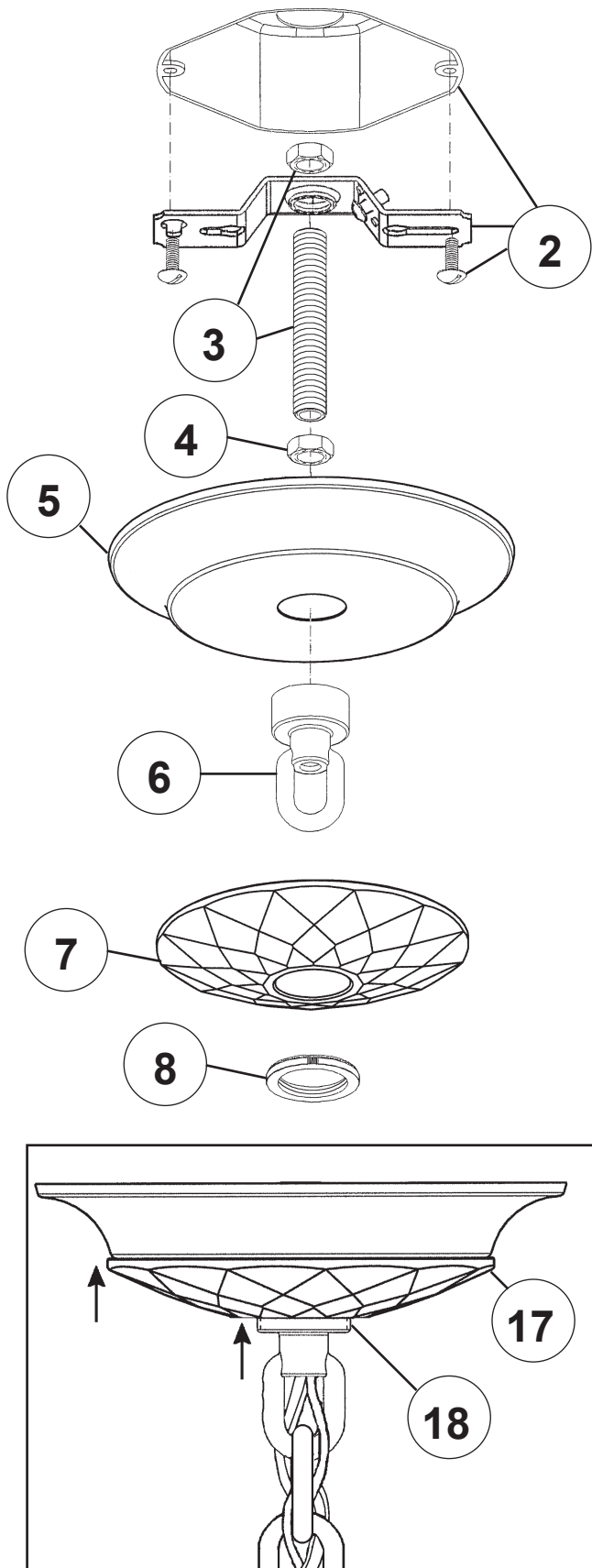



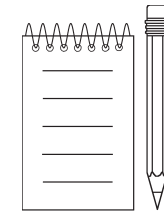
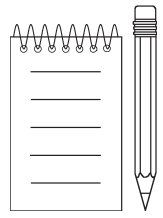

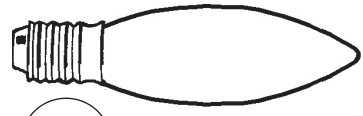

19

You will need 12 - B10  
25 Watts Recommended  
60 Watts Max

Install bulbs and be sure  
to test fixture **BEFORE**  
trimming.

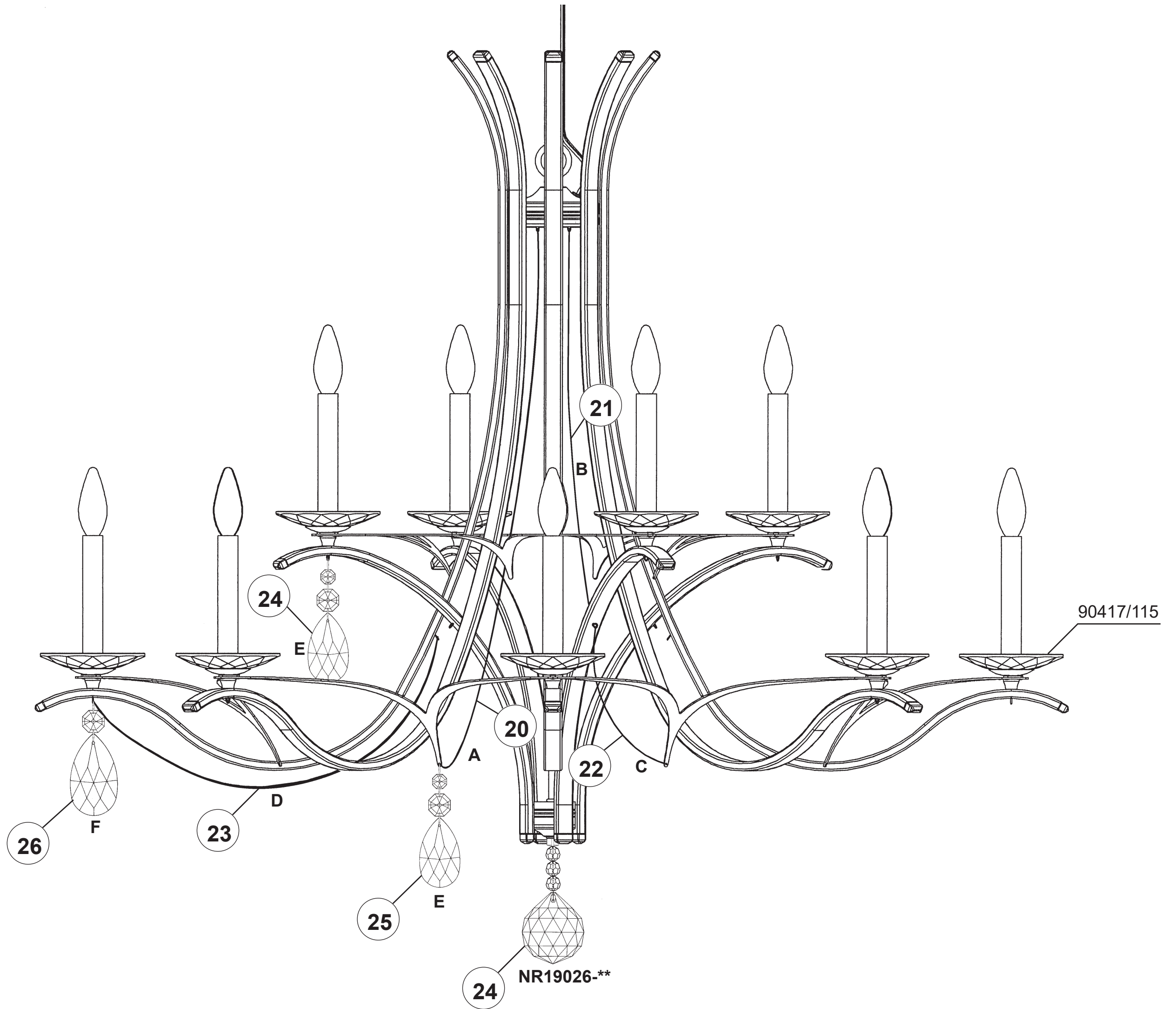



VESCA VA8322N- \_\_ \_\_ S

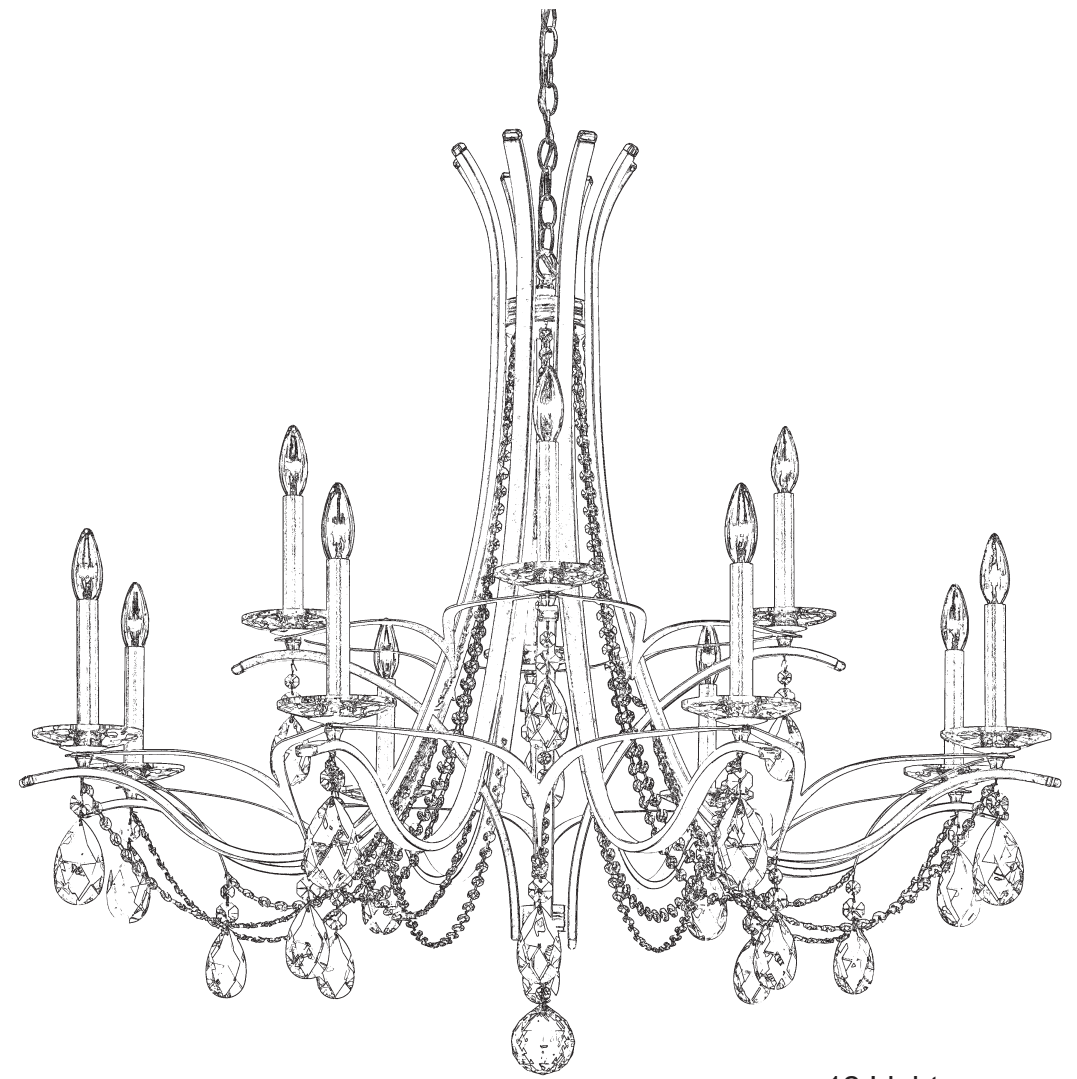











12 Lights  
Diameter: 45"  
Height: 40"  
Hanging Weight: 38lbs.

**T**HIS DESIGN IS THE PROPRIETARY  
TRADE DRESS/TRADEMARK OF  
W SCHONBEK LLC.

 **SCHONBEK** | 1870

 **SCHONBEK** | 1870

								
MAX <u>60</u> W	110-120 V							

**WARNING:**

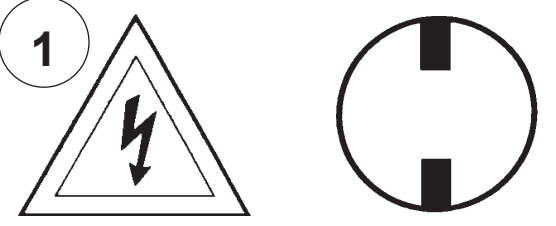
1 

**Electrical Danger Turn Power Off**

All electrical components must be installed by a licensed electrician in accordance with the National Electric Code and the appropriate local electrical codes.

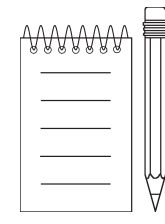
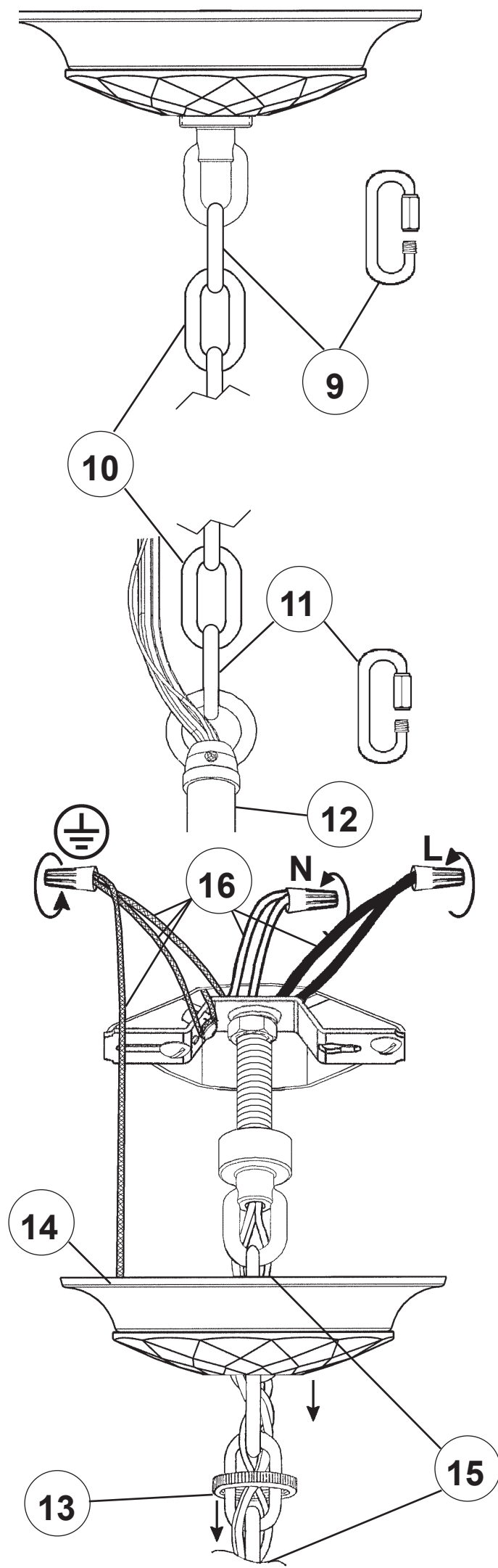
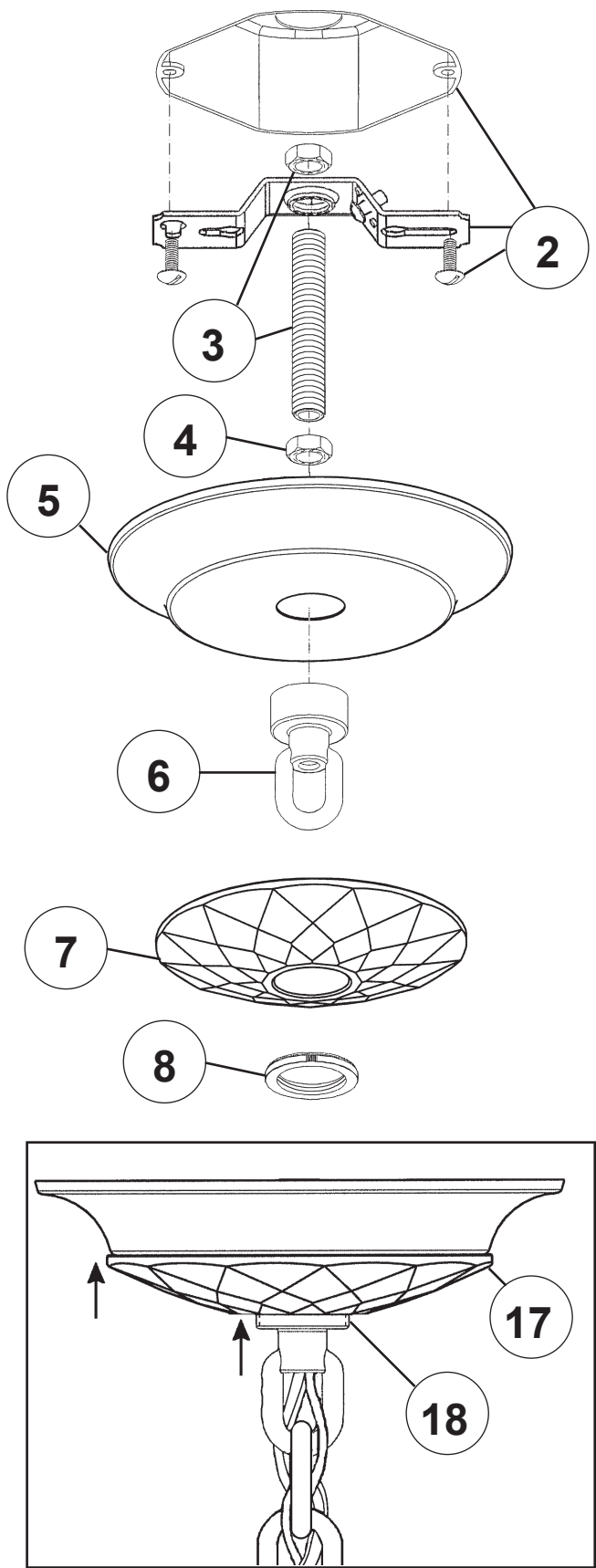

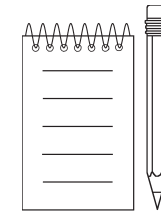

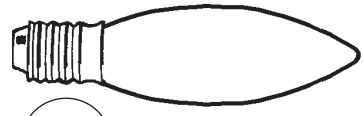

19

You will need 12 - B10  
25 Watts Recommended  
60 Watts Max

Install bulbs and be sure  
to test fixture **BEFORE**  
trimming.

