

BARONET BN1224N- __ __ O

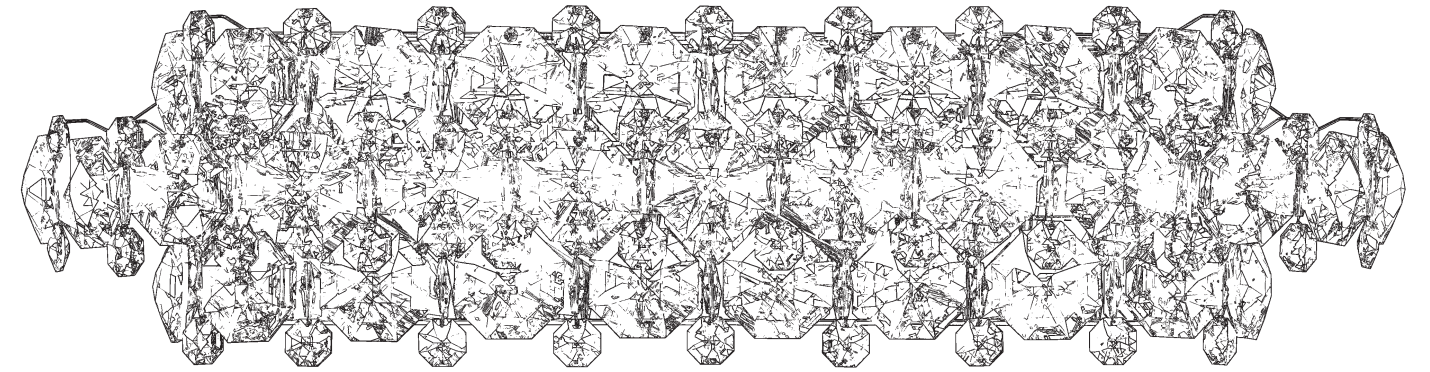

5 Lights
Diameter: 25"
Height: 6-1/2"
Extension: 6-1/2"
Hanging Weight: 11lbs.

THIS DESIGN IS THE PROPRIETARY
TRADE DRESS/TRADEMARK OF
W SCHONBEK LLC.

 **SCHONBEK** | 1870

 **SCHONBEK** | 1870

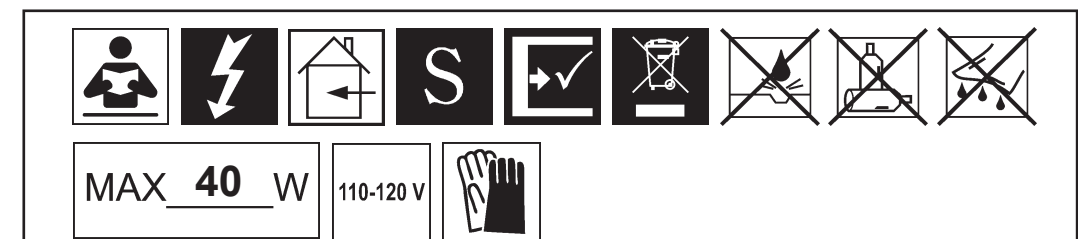

WARNING:

1

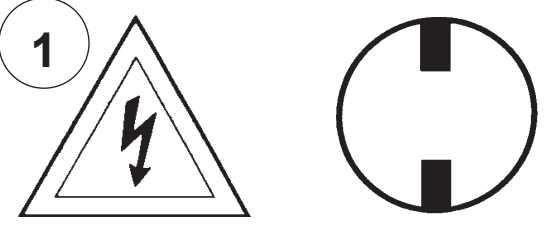

Electrical Danger **Turn Power Off**

All electrical components must be installed by a licensed electrician in accordance with the National Electric Code and the appropriate local electrical codes.

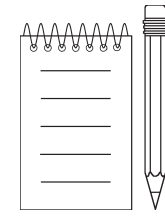
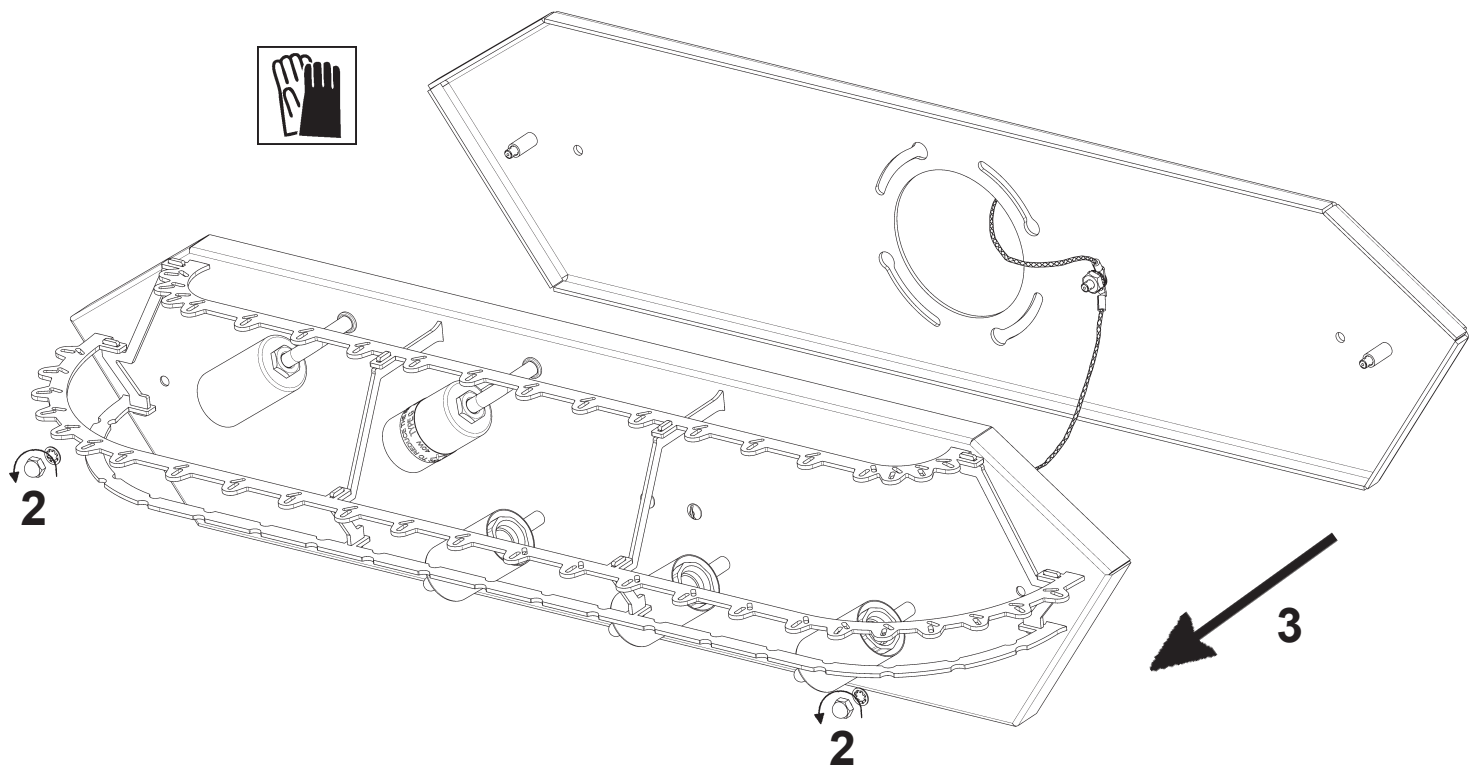

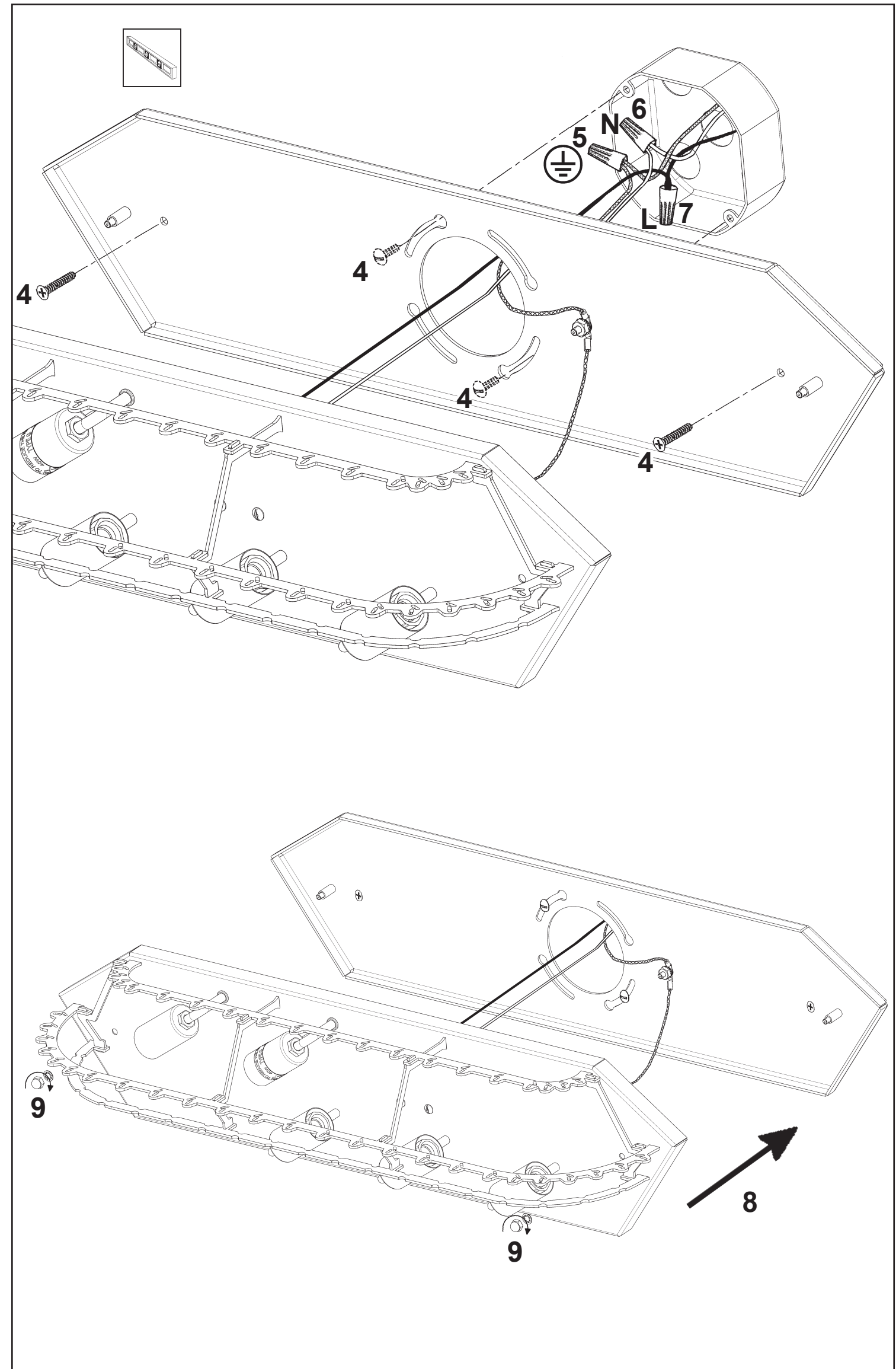

10

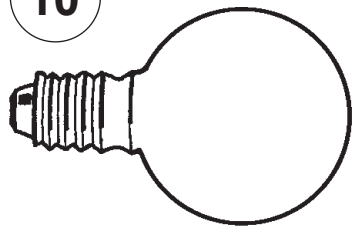

You will need 5 - G16-1/2
40 Watts Max

Install bulbs and be sure
to test fixture BEFORE
trimming.

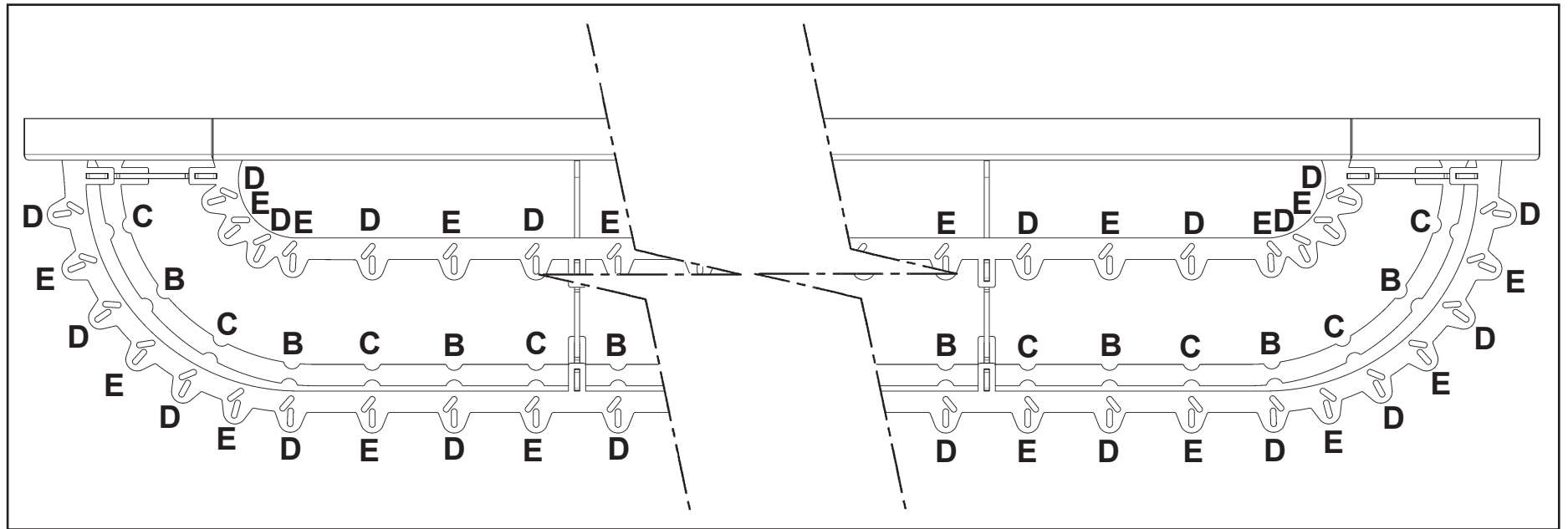
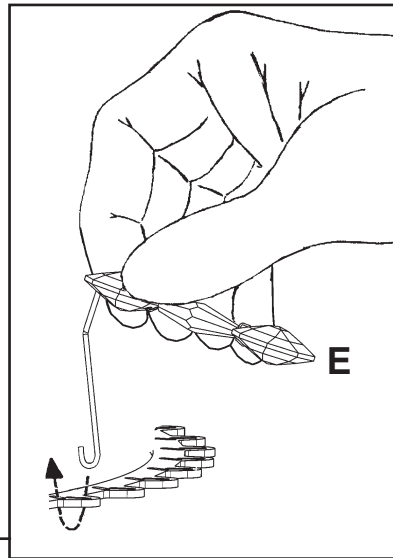

13

14

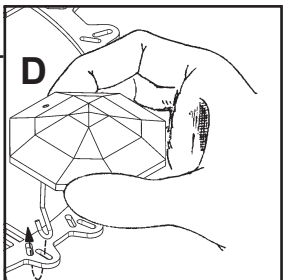

15

16

11

12

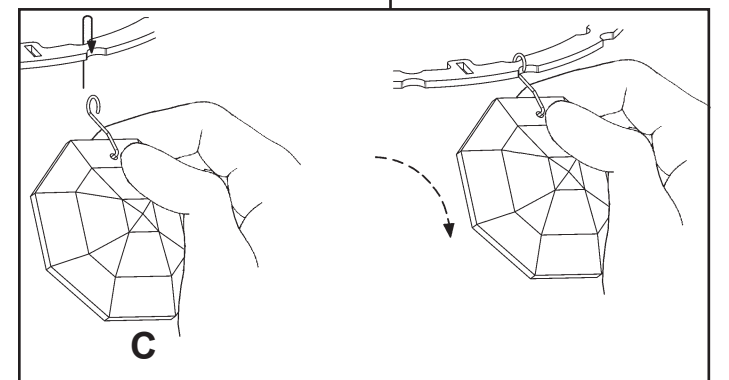
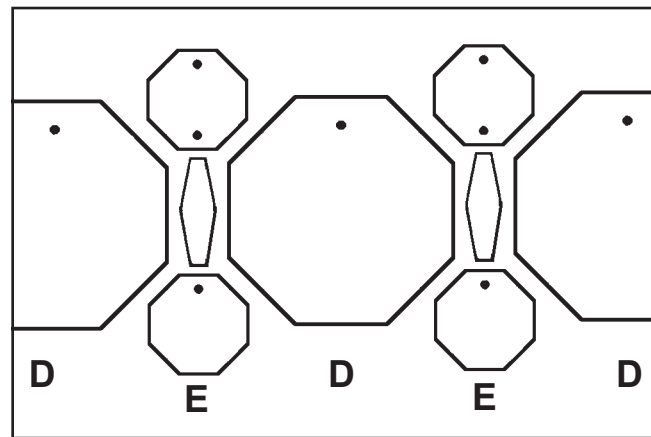
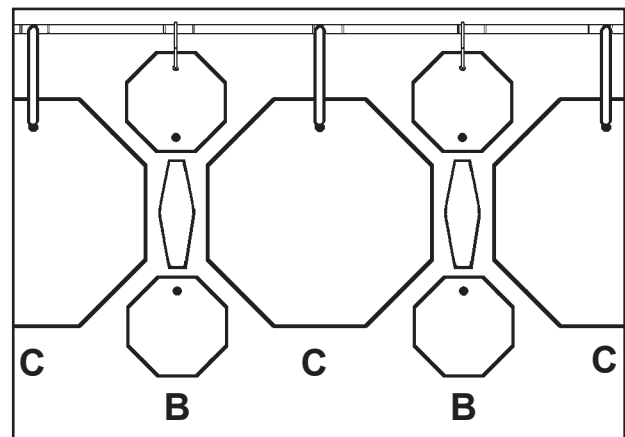
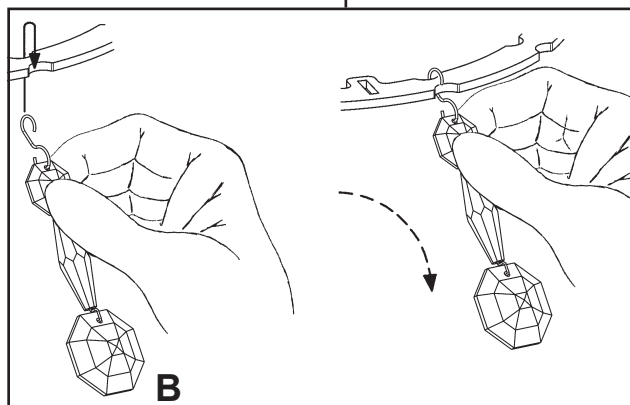

BARONET BN1224N- __ __ R

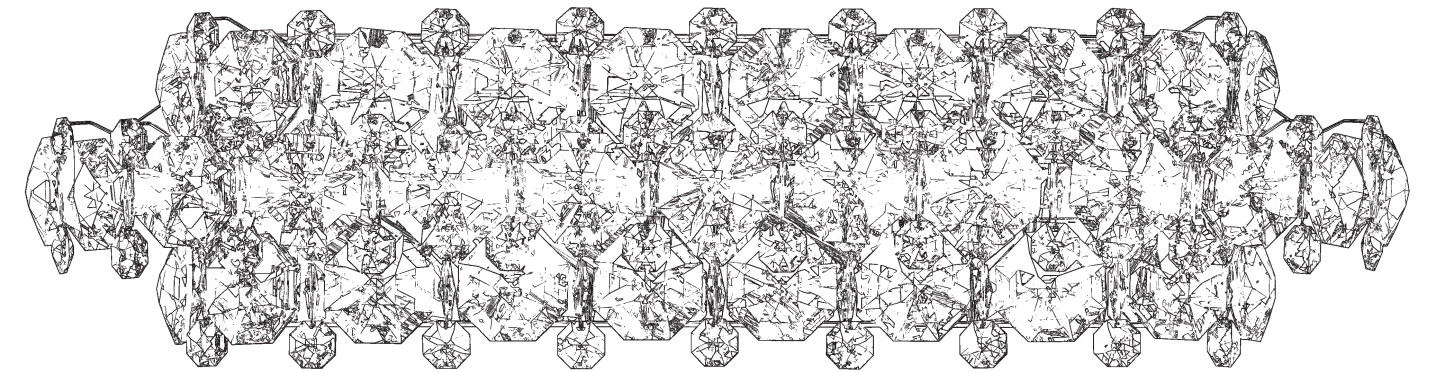











5 Lights
Diameter: 25"
Height: 6-1/2"
Extension: 6-1/2"
Hanging Weight: 11lbs.

THIS DESIGN IS THE PROPRIETARY
TRADE DRESS/TRADEMARK OF
W SCHONBEK LLC.

 **SCHONBEK** | 1870

 **SCHONBEK** | 1870

								
MAX <u>40</u> W	110-120 V							

WARNING:

1

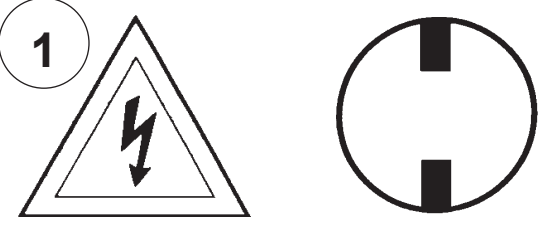

Electrical Danger **Turn Power Off**

All electrical components must be installed by a licensed electrician in accordance with the National Electric Code and the appropriate local electrical codes.

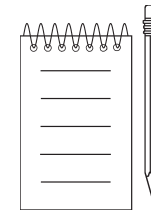
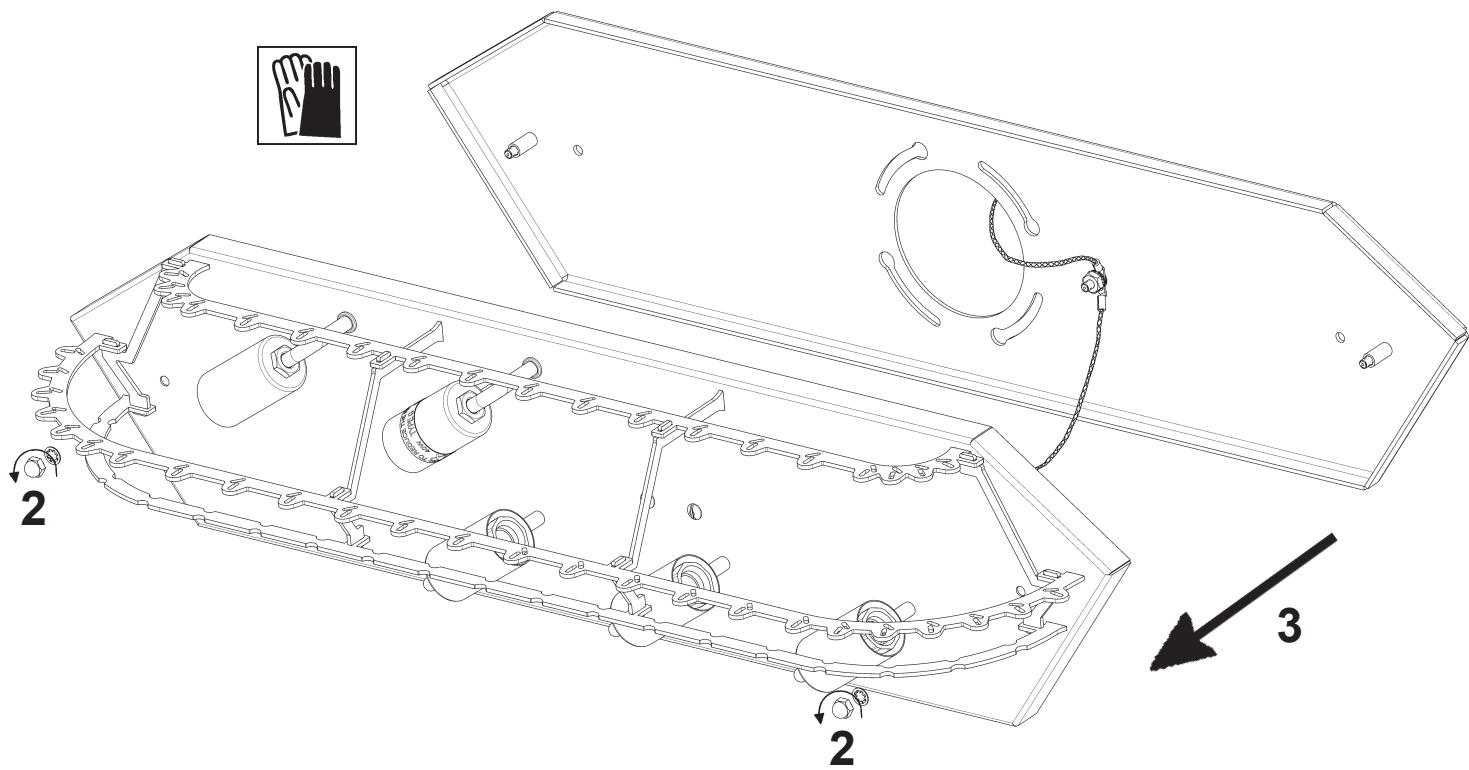

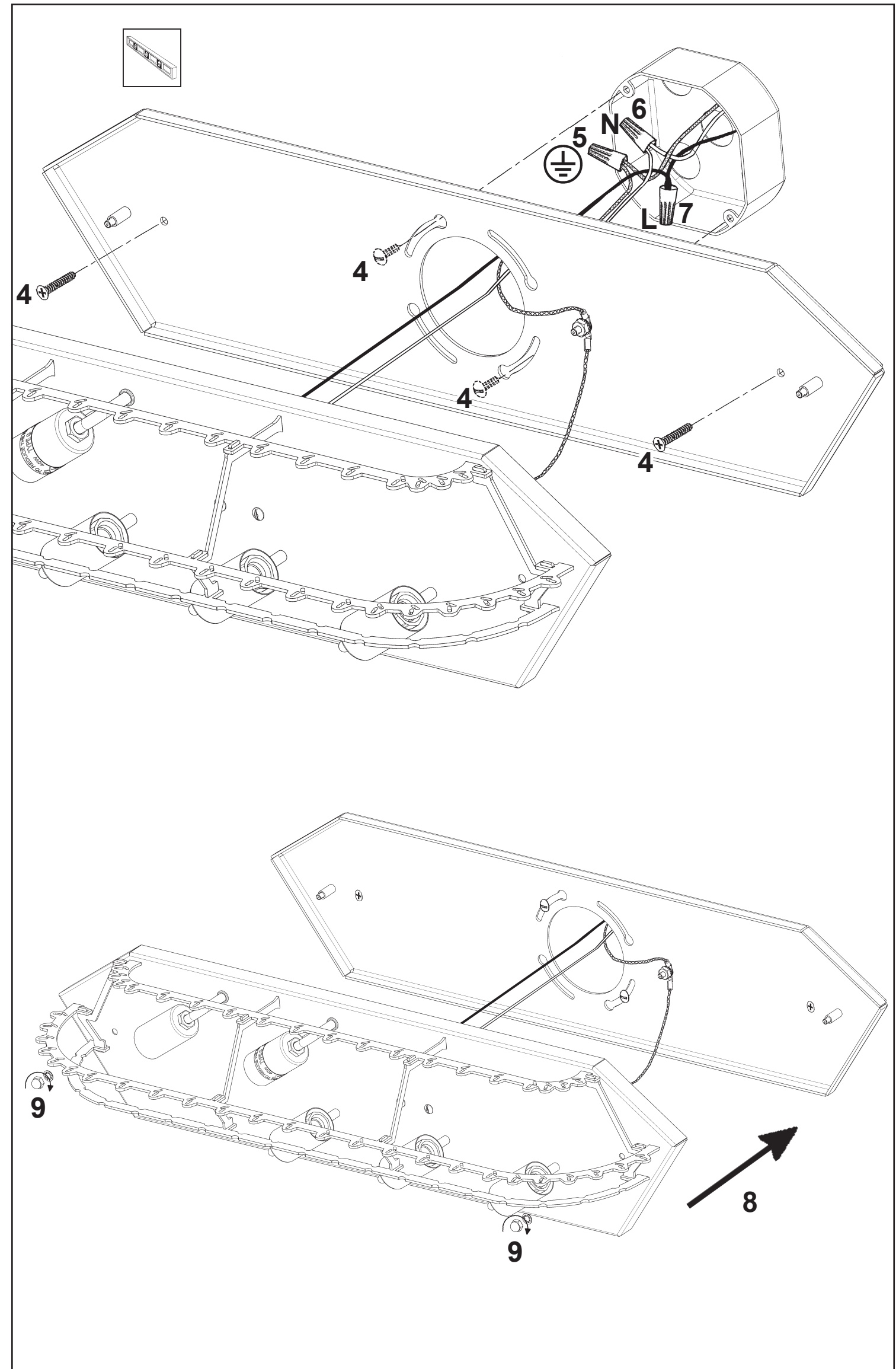
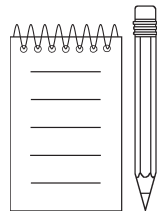

10

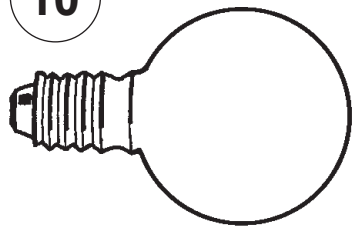

You will need 5 - G16-1/2
40 Watts Max

Install bulbs and be sure
to test fixture **BEFORE**
trimming.

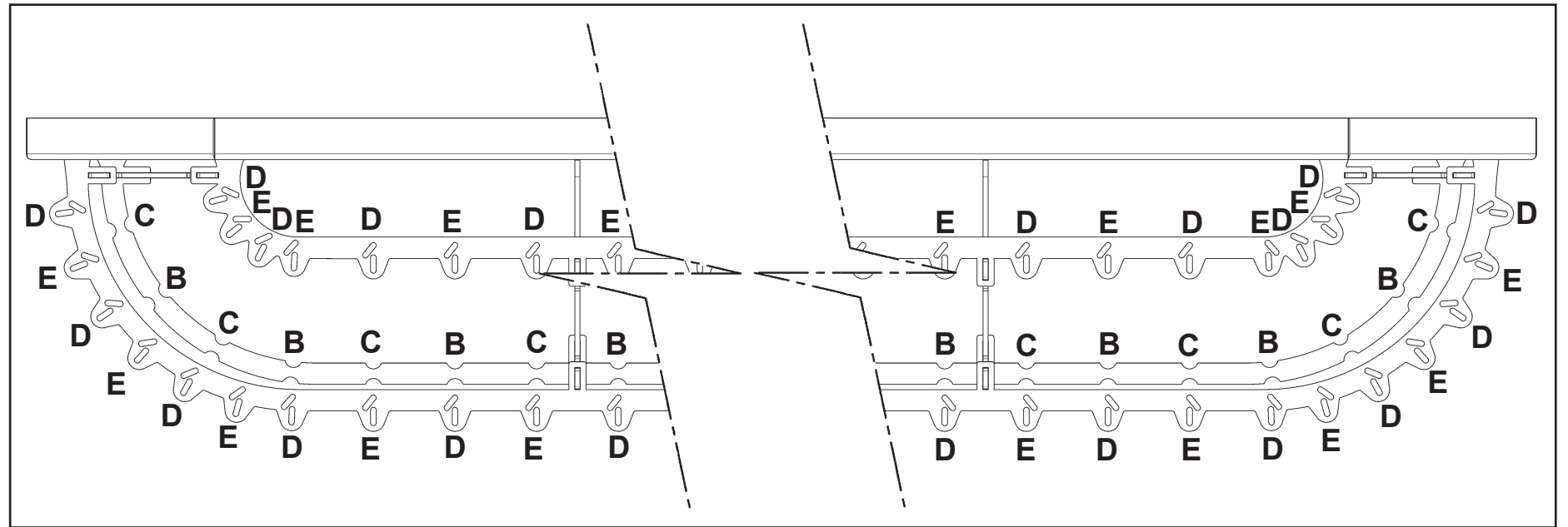
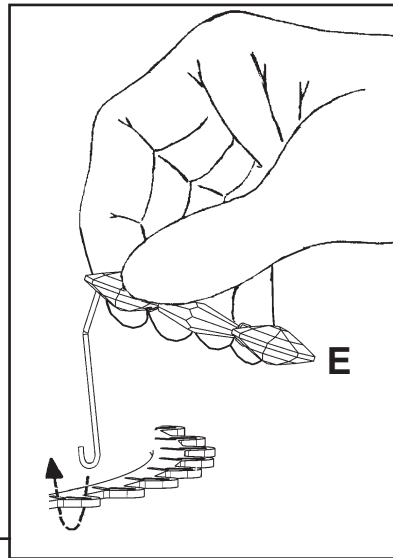

13

15

11

E

B

14

D

16

D

12

C

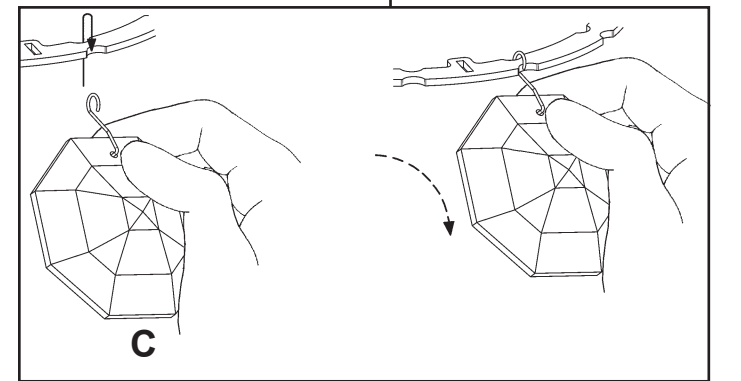
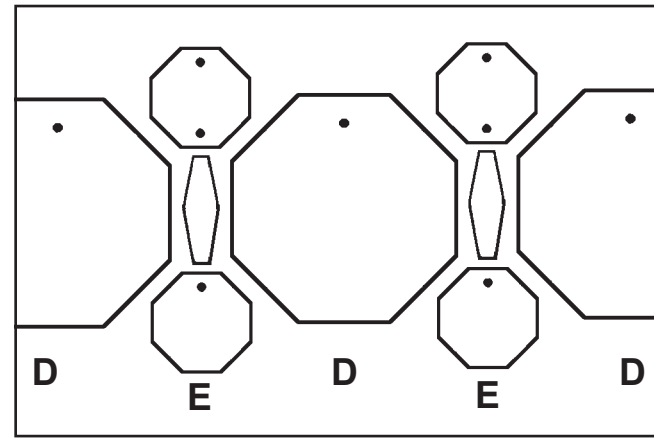
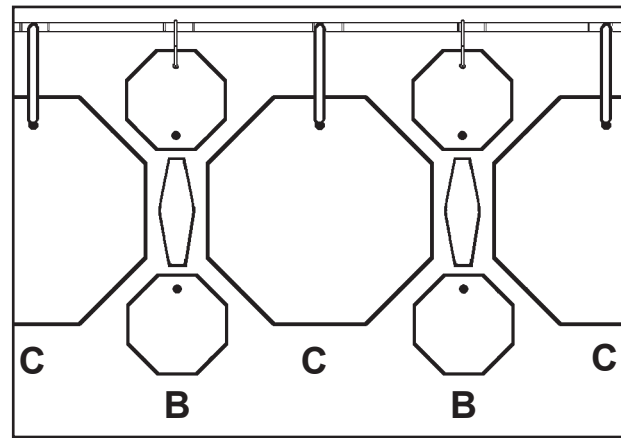
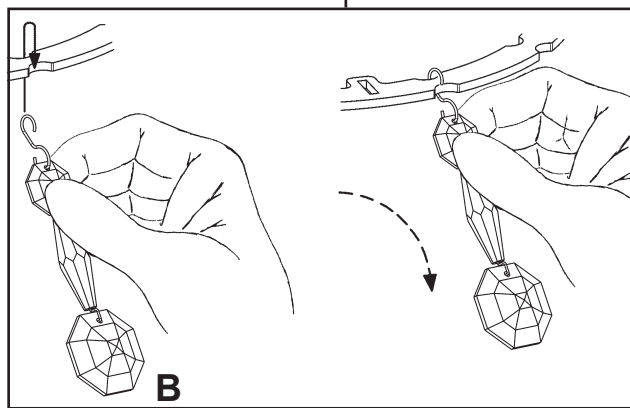

BARONET BN1224N- __ __ S

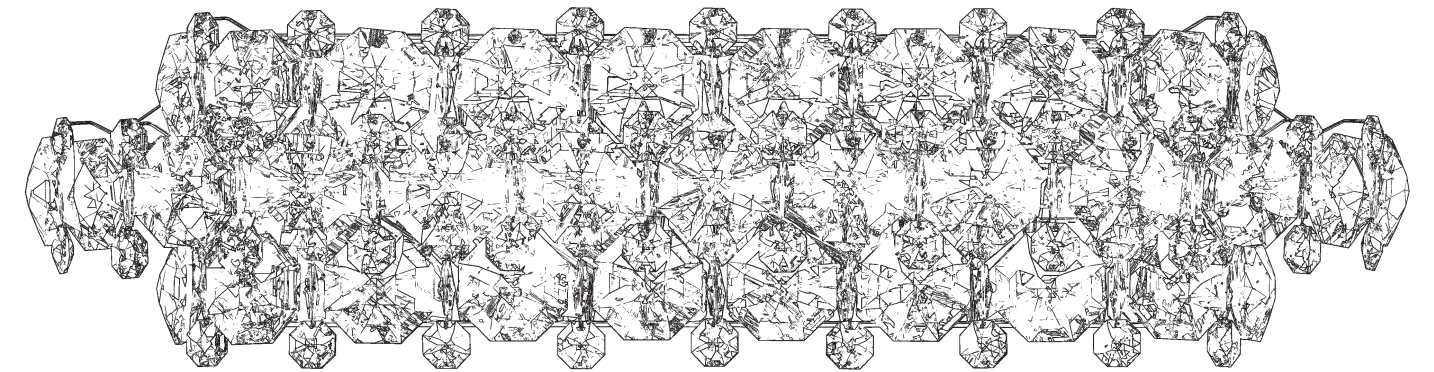











5 Lights
Diameter: 25"
Height: 6-1/2"
Extension: 6-1/2"
Hanging Weight: 11lbs.

THIS DESIGN IS THE PROPRIETARY
TRADE DRESS/TRADEMARK OF
W SCHONBEK LLC.

 **SCHONBEK** | 1870

 **SCHONBEK** | 1870

								
MAX <u>40</u> W	110-120 V							

WARNING:

1

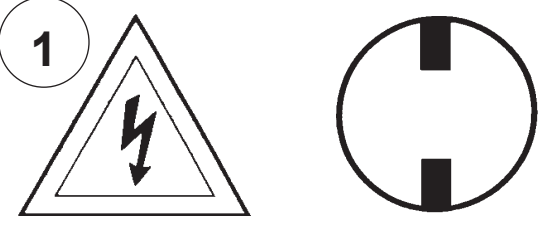

Electrical Danger **Turn Power Off**

All electrical components must be installed by a licensed electrician in accordance with the National Electric Code and the appropriate local electrical codes.

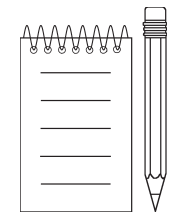
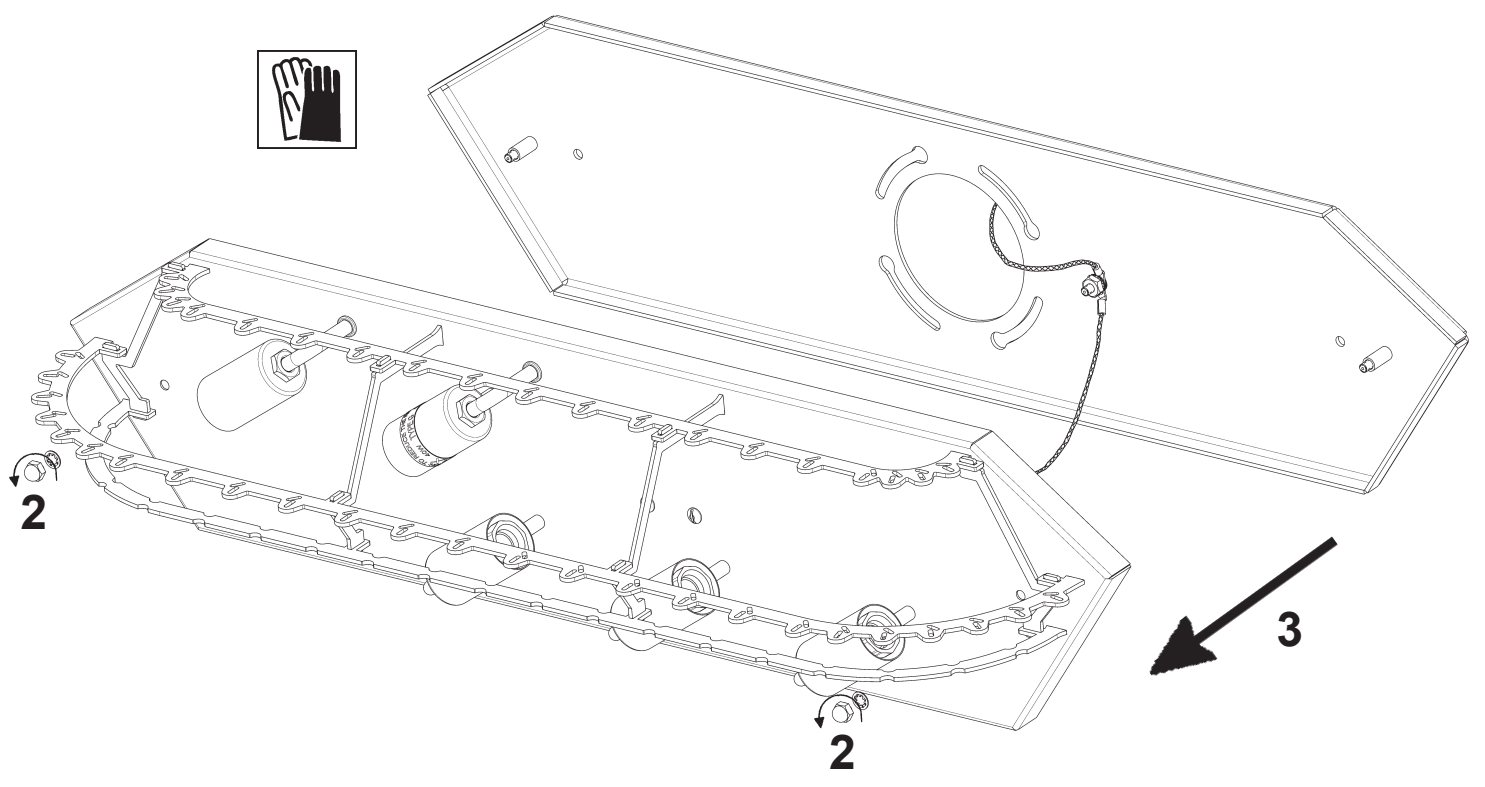

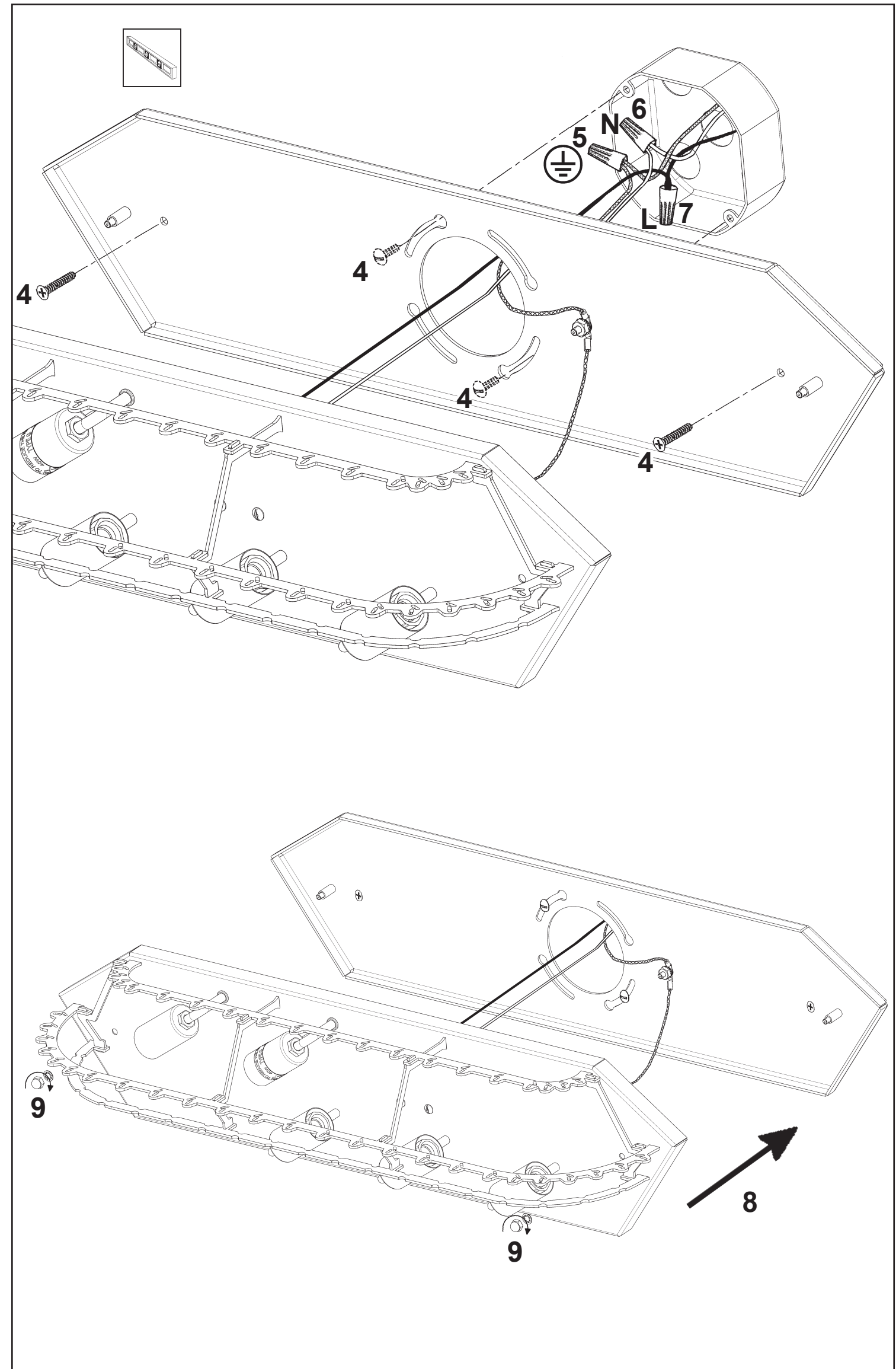

10

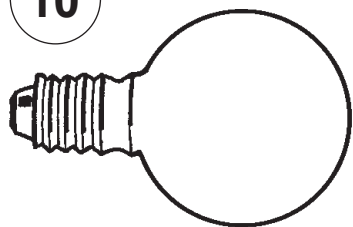

You will need 5 - G16-1/2
40 Watts Max

Install bulbs and be sure
to test fixture BEFORE
trimming.

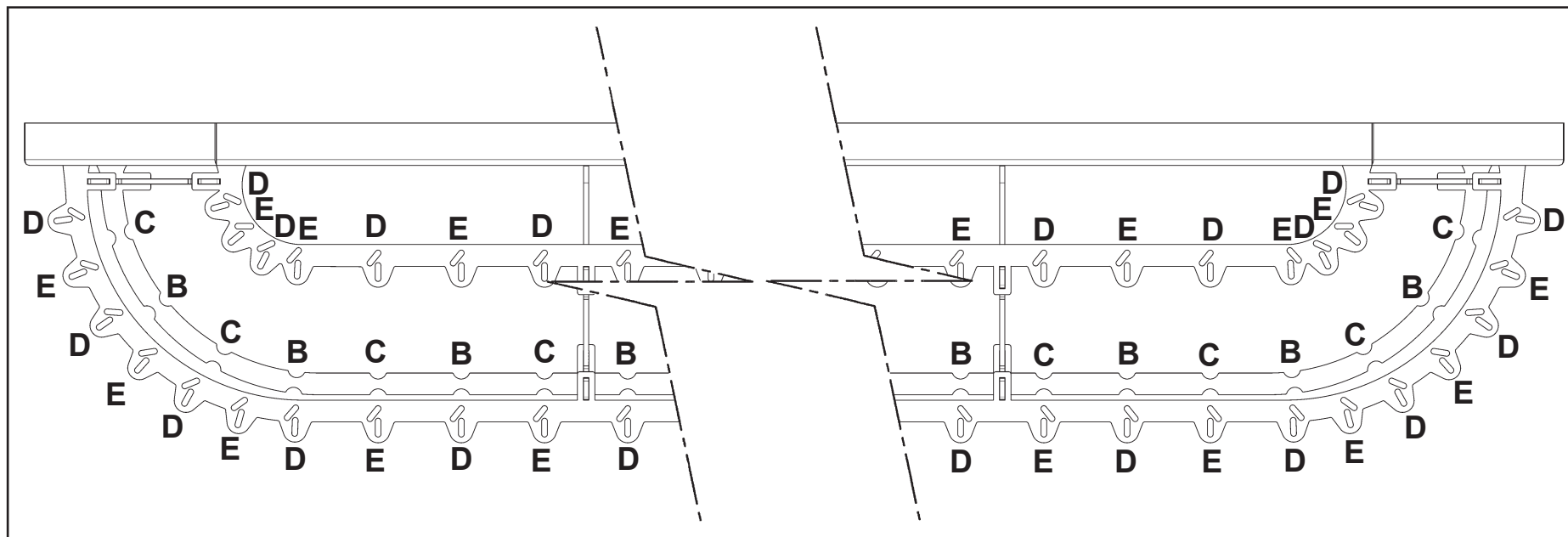
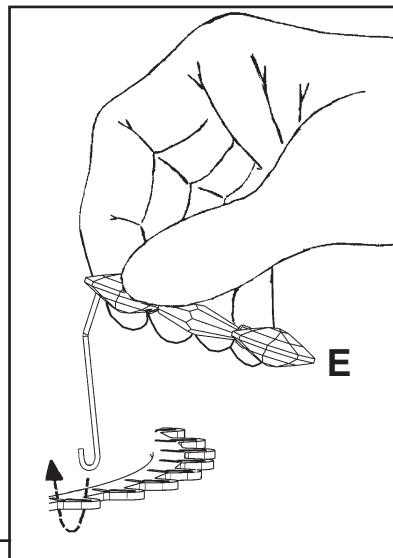

13

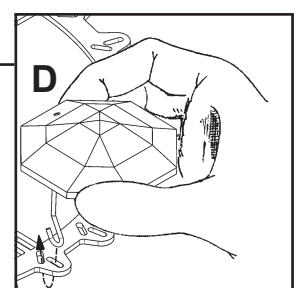
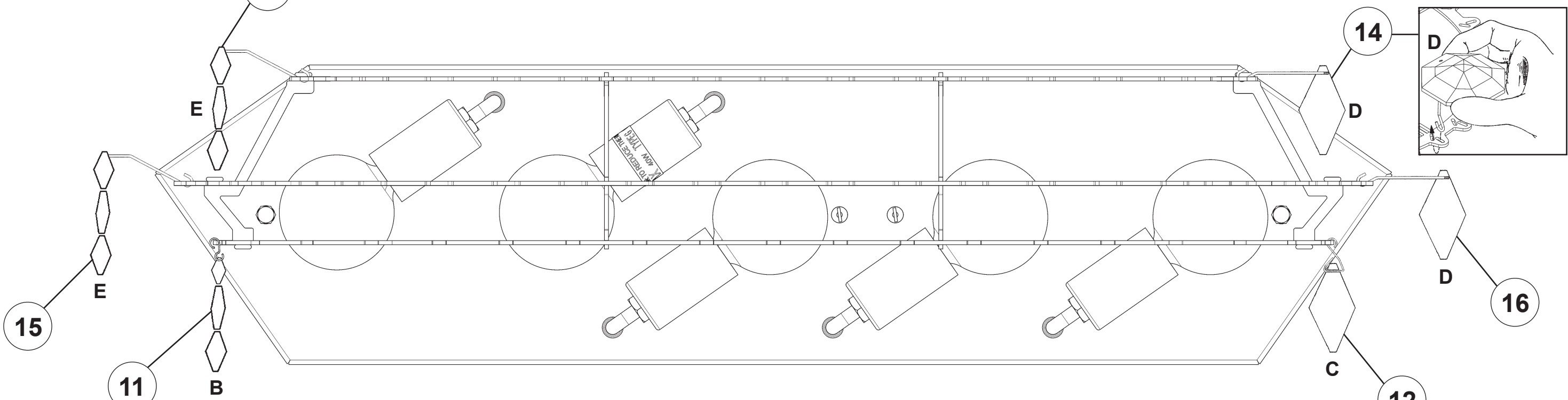

14

16

15

11

12

