

BELLA ROSE TC1018N-__ __H

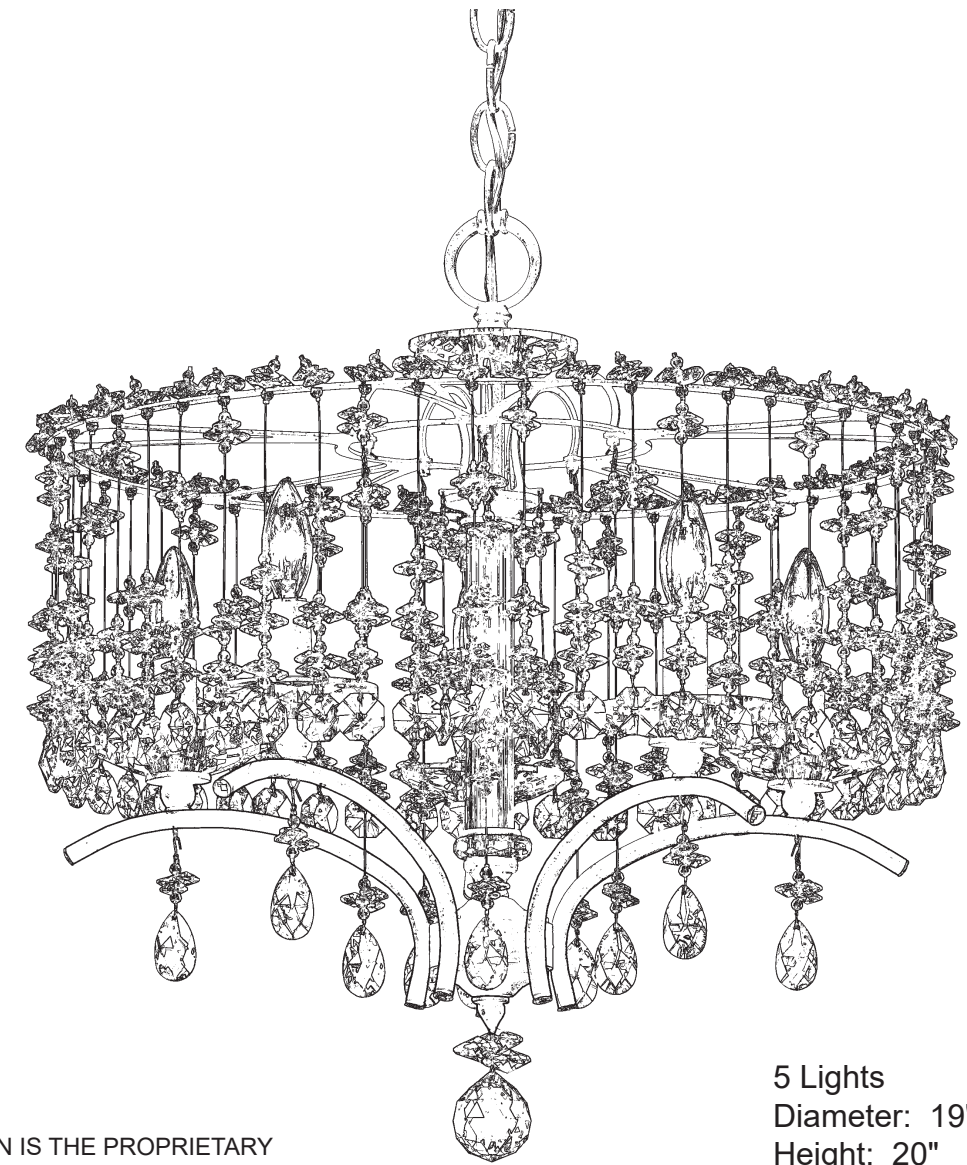











5 Lights
Diameter: 19"
Height: 20"
Hanging Weight: 14lbs.

THIS DESIGN IS THE PROPRIETARY
TRADE DRESS/TRADEMARK OF
W SCHONBEK LLC.

 **SCHONBEK** | 1870

 **SCHONBEK** | 1870

								
MAX 60 W	110-120 V							

WARNING:

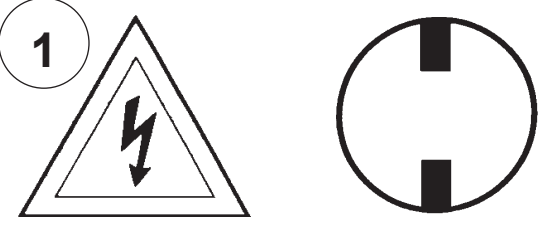
1 

Electrical Danger Turn Power Off

All electrical components must be installed by a licensed electrician in accordance with the National Electric Code and the appropriate local electrical codes.

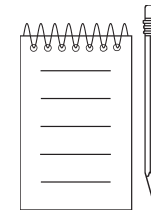
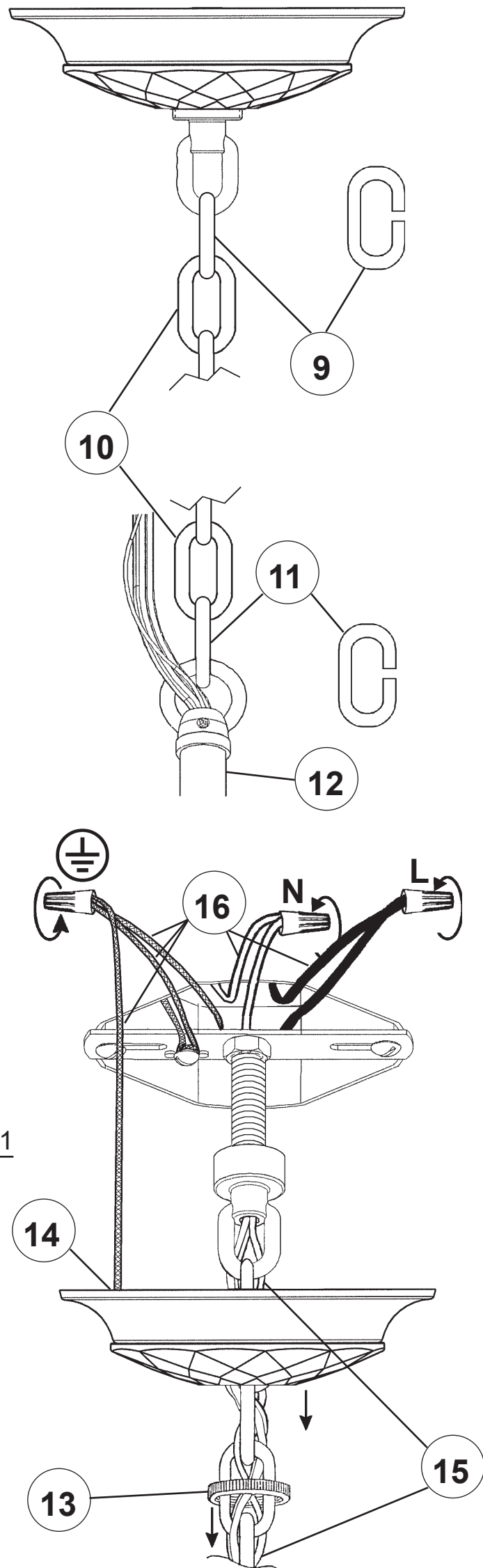
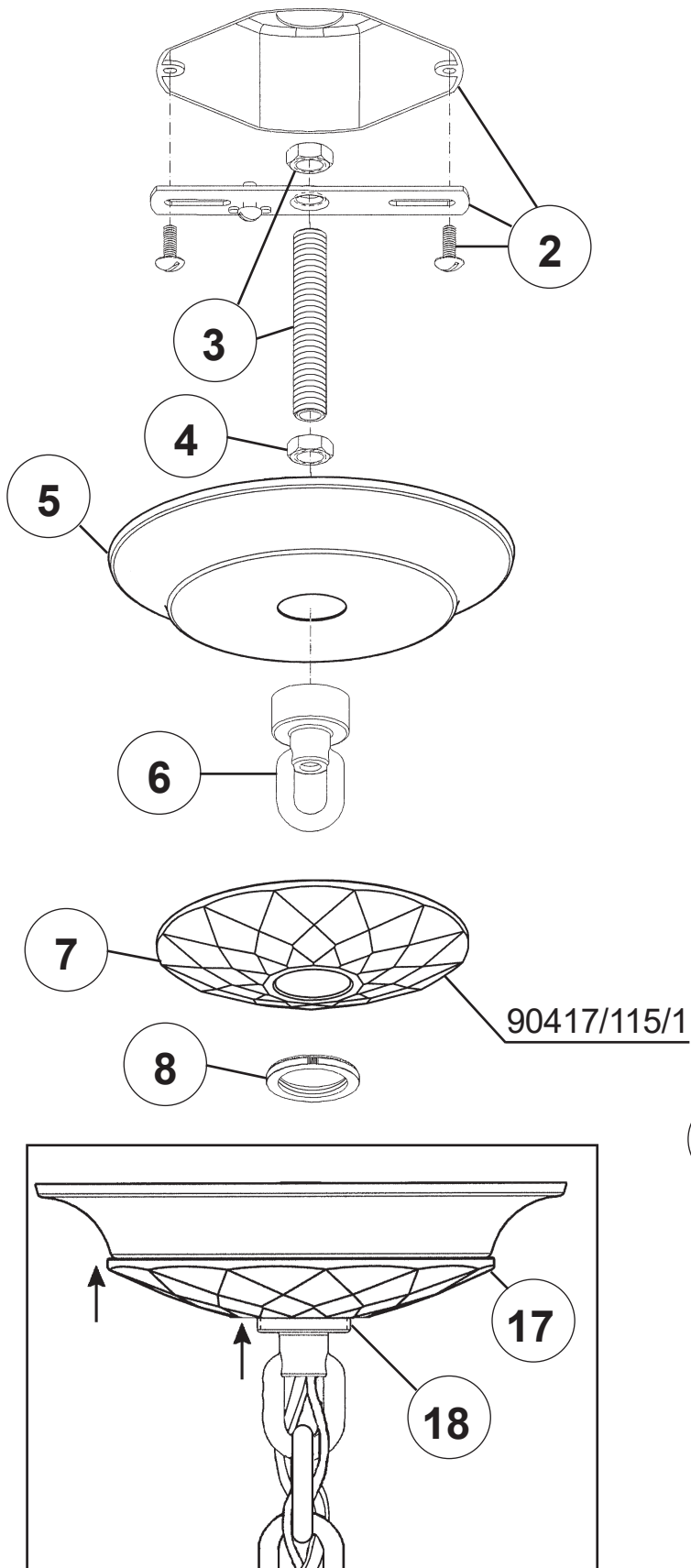

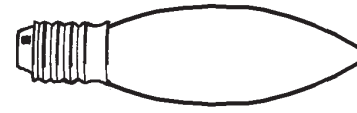
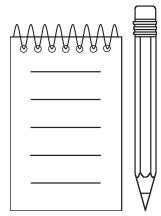

You will need 5 - B10
60 Watts Max

**Install bulbs and be sure
to test fixture BEFORE
trimming.**

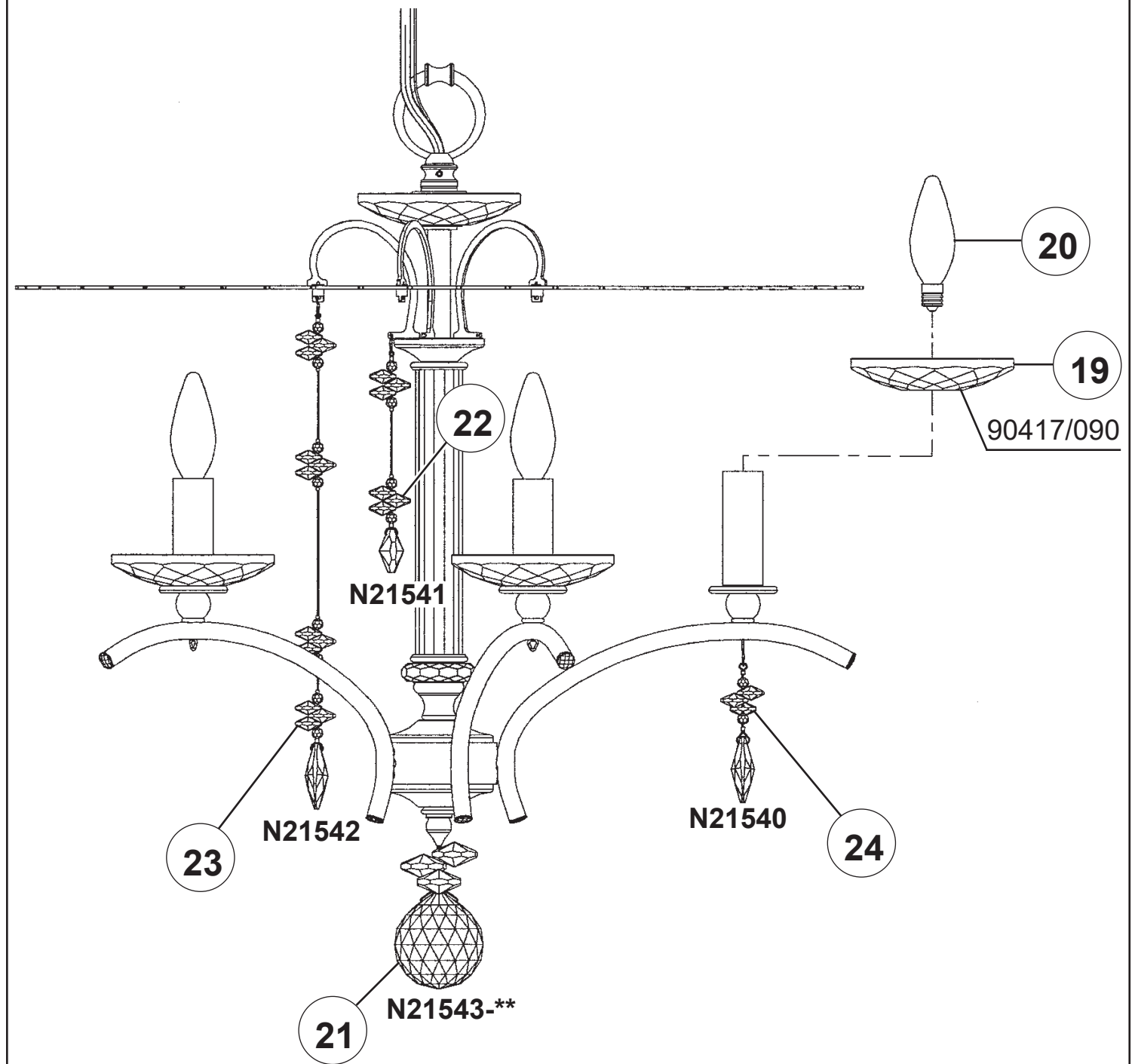

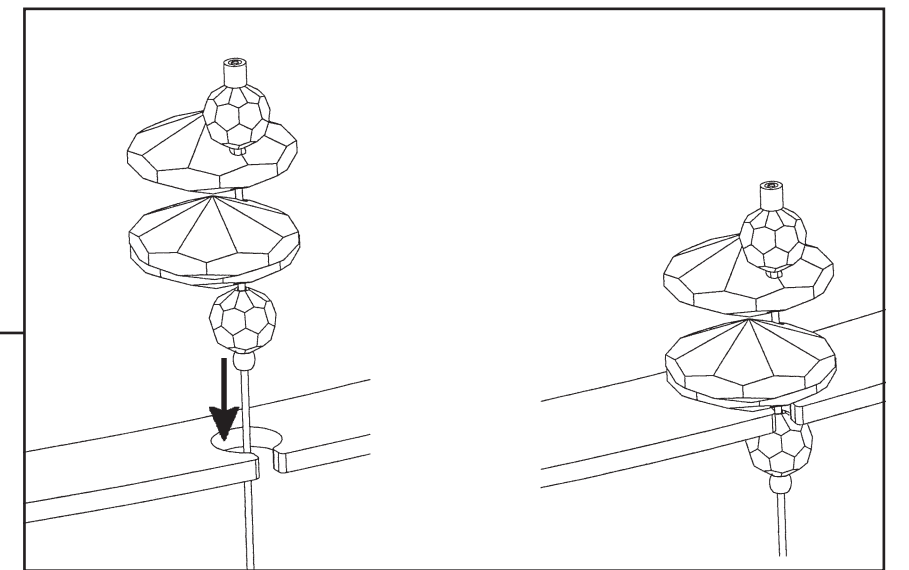
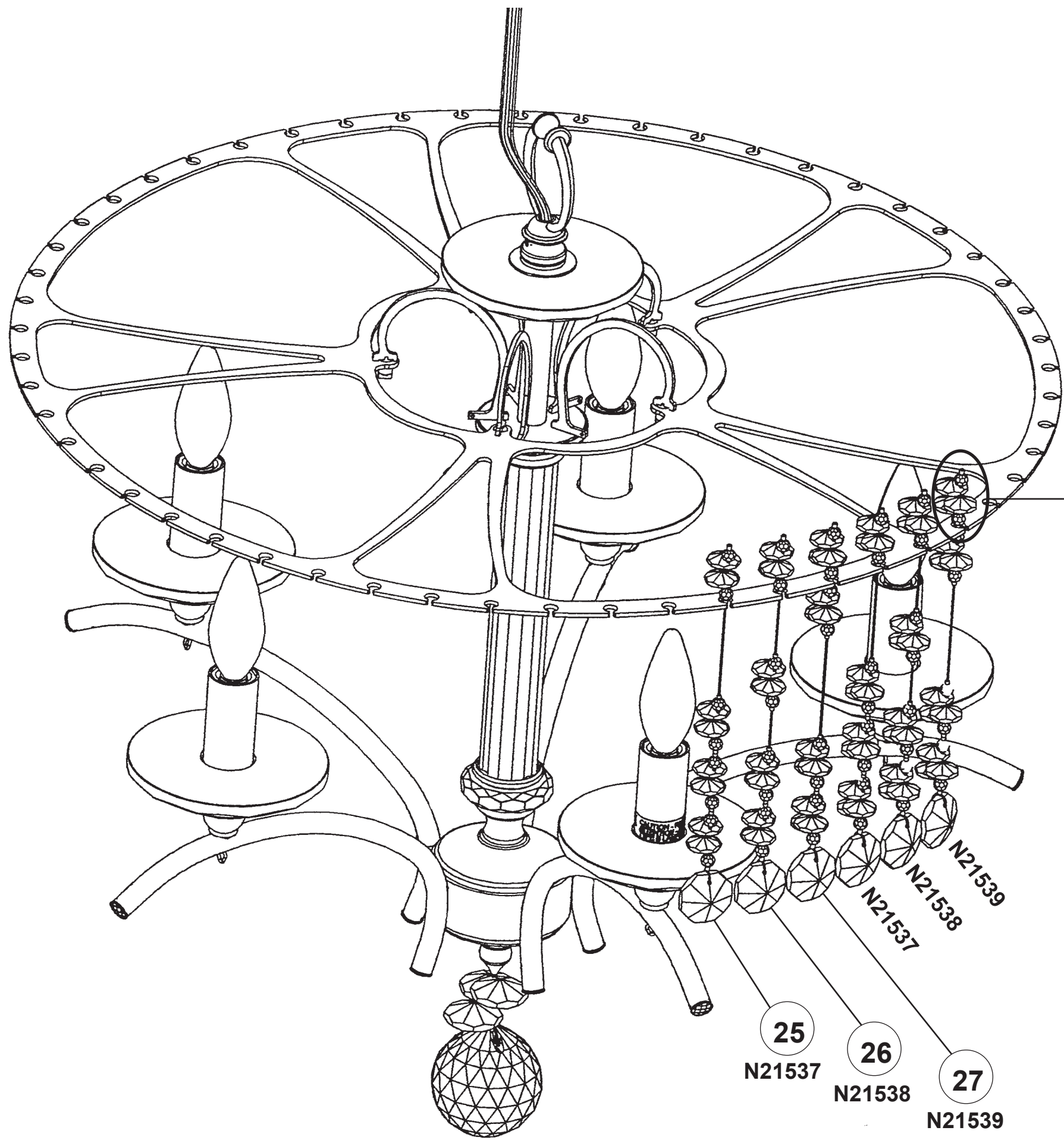

BELLA ROSE TC1018N-__ __R













THIS DESIGN IS THE PROPRIETARY TRADE DRESS/TRADemark OF W SCHONBEK LLC.

5 Lights
Diameter: 19"
Height: 20"
Hanging Weight: 14lbs.

 **SCHONBEK** | 1870

 **SCHONBEK** | 1870

								
MAX <u>60</u> W	110-120 V							

WARNING:

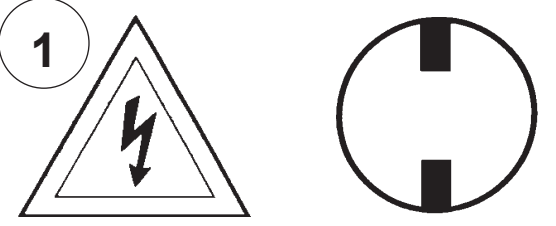
1 

Electrical Danger Turn Power Off

All electrical components must be installed by a licensed electrician in accordance with the National Electric Code and the appropriate local electrical codes.

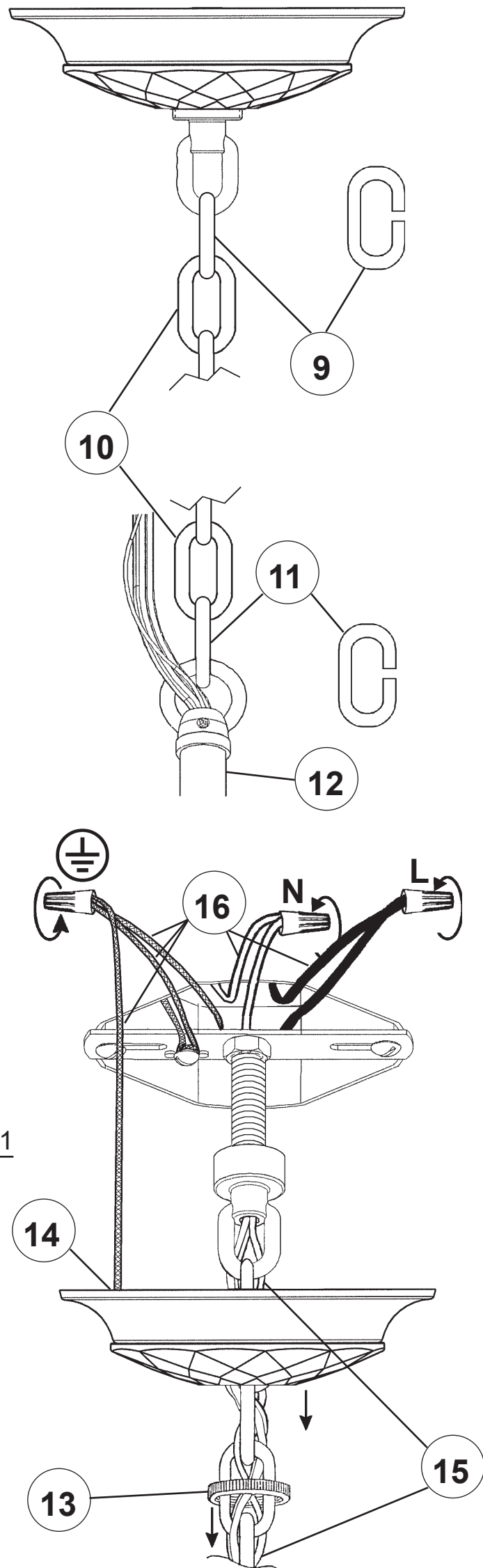
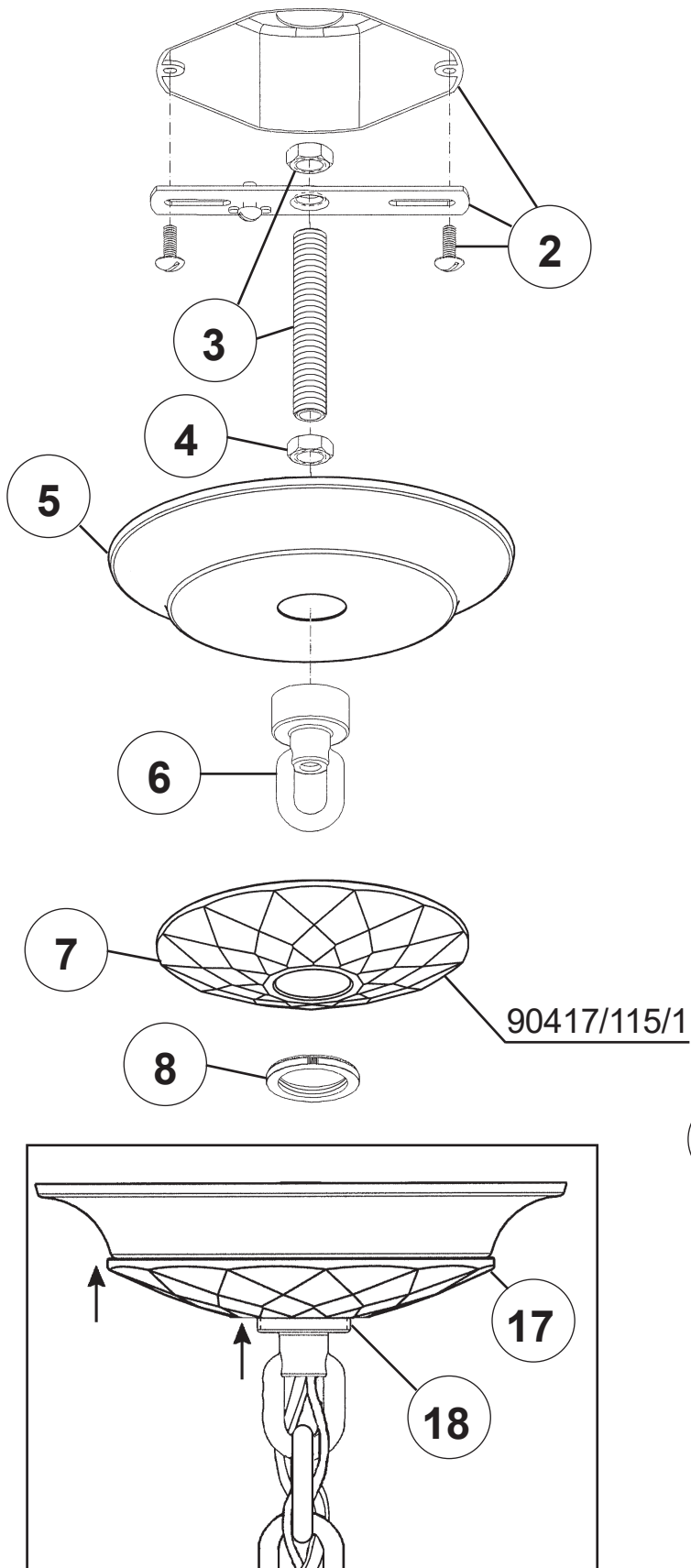

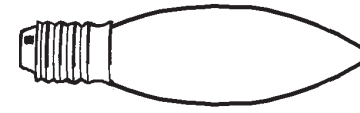
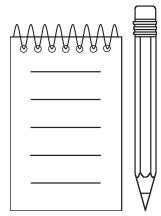

You will need 5 - B10
60 Watts Max

**Install bulbs and be sure
to test fixture BEFORE
trimming.**

