

 **SCHONBEK** | 1870











ESMERY AR1004N-__ __O



THIS DESIGN IS THE PROPRIETARY
TRADE DRESS/TRADEMARK OF
W SCHONBEK LLC.

4 Lights
Diameter: 21"
Height: 21-1/2"
Hanging Weight: 8lbs.

 **SCHONBEK** | 1870

								
MAX <u>60</u> W	110-120 V							

WARNING:

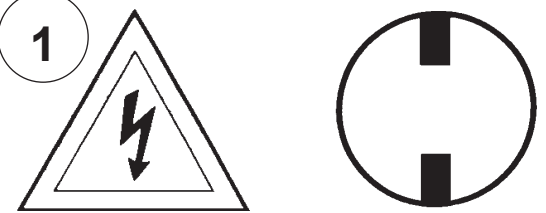
1 

Electrical Danger Turn Power Off

All electrical components must be installed by a licensed electrician in accordance with the National Electric Code and the appropriate local electrical codes.

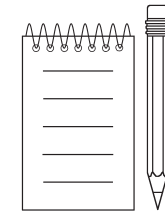
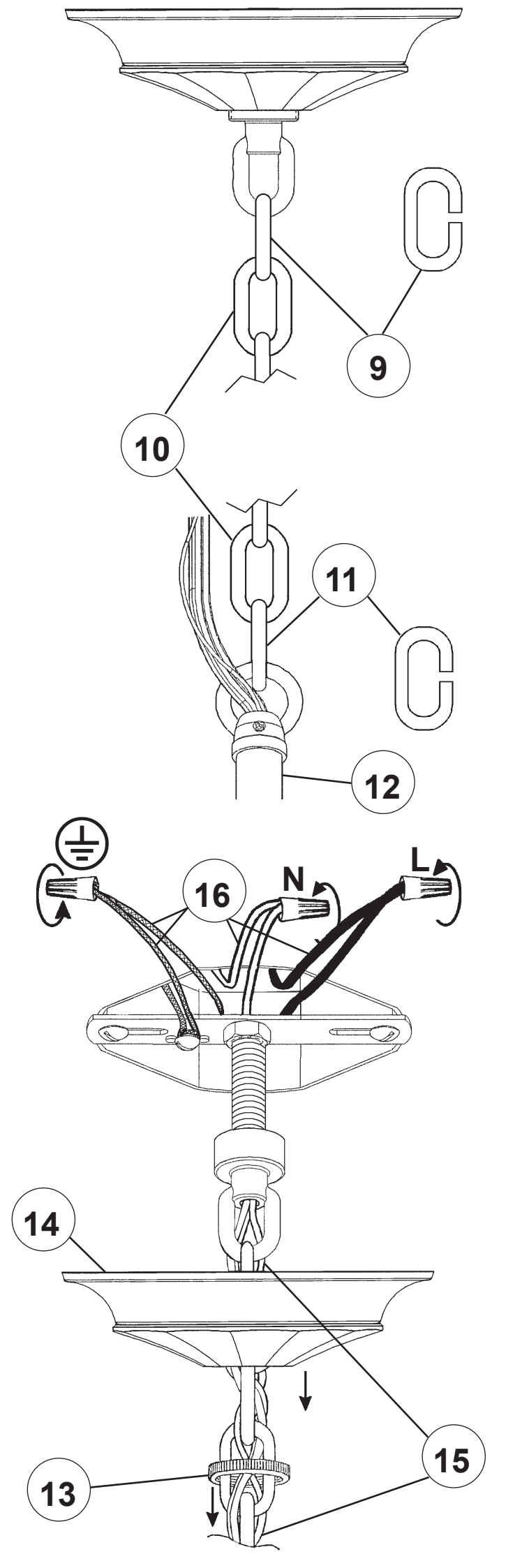
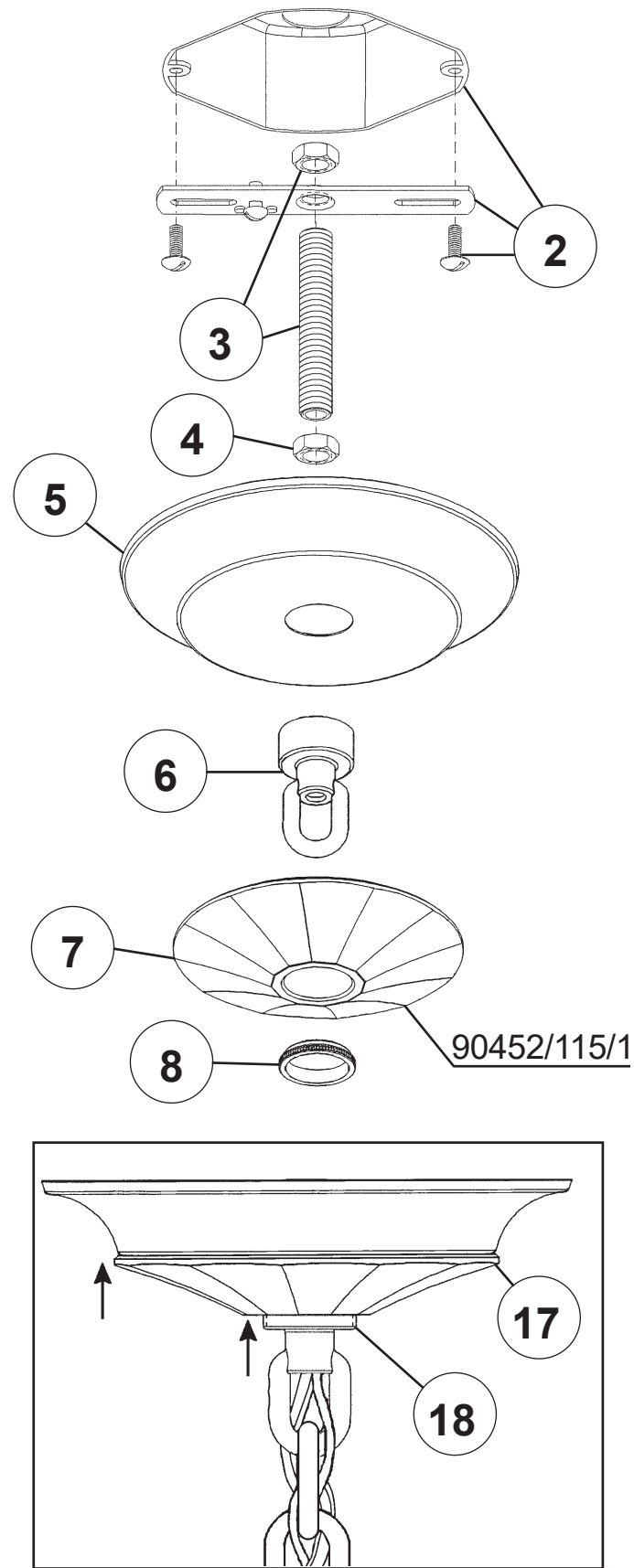

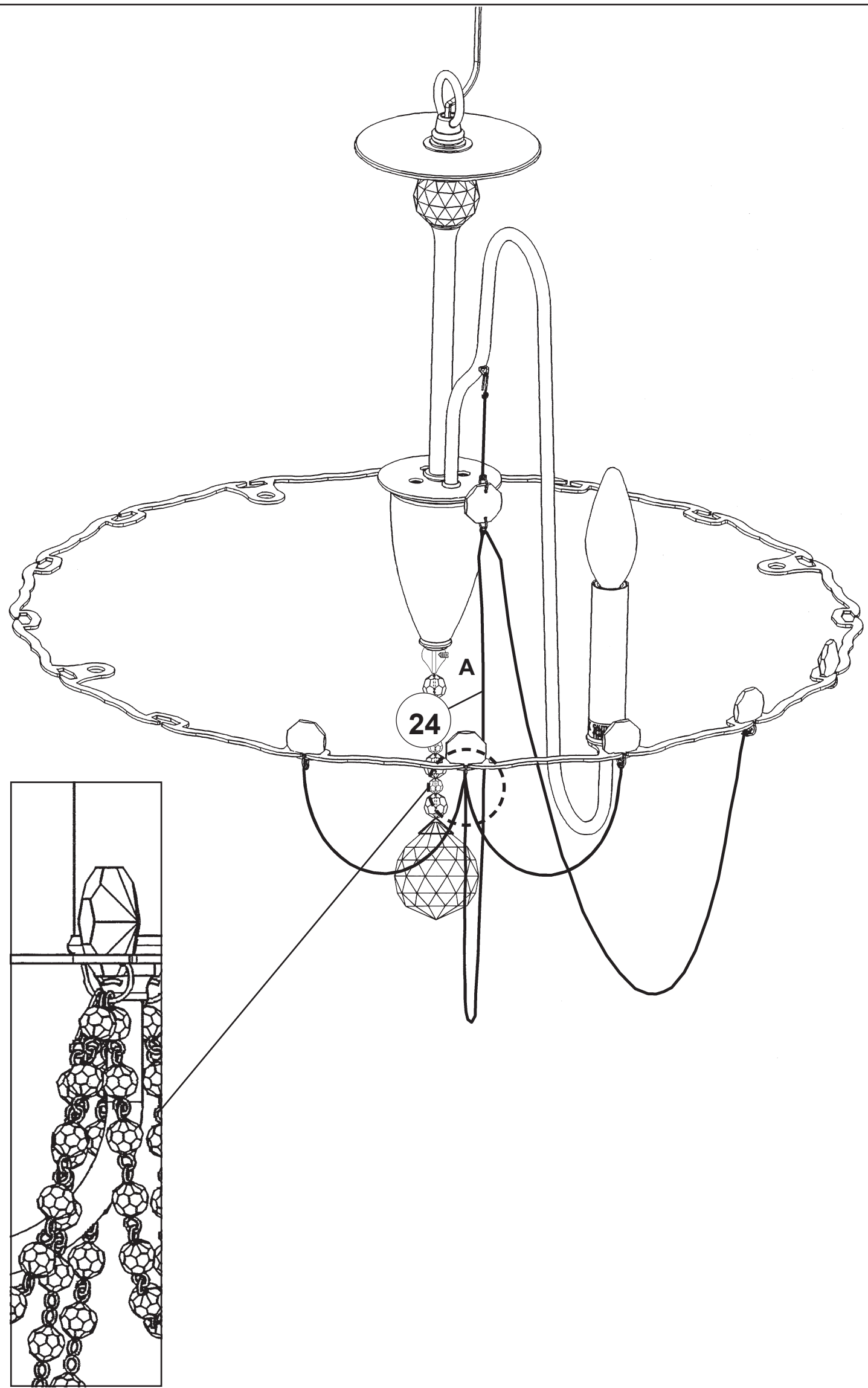

19



You will need 4 - B10
25 Watts Recommended
60 Watts Max

**Install bulbs and be sure
to test fixture BEFORE
trimming.**

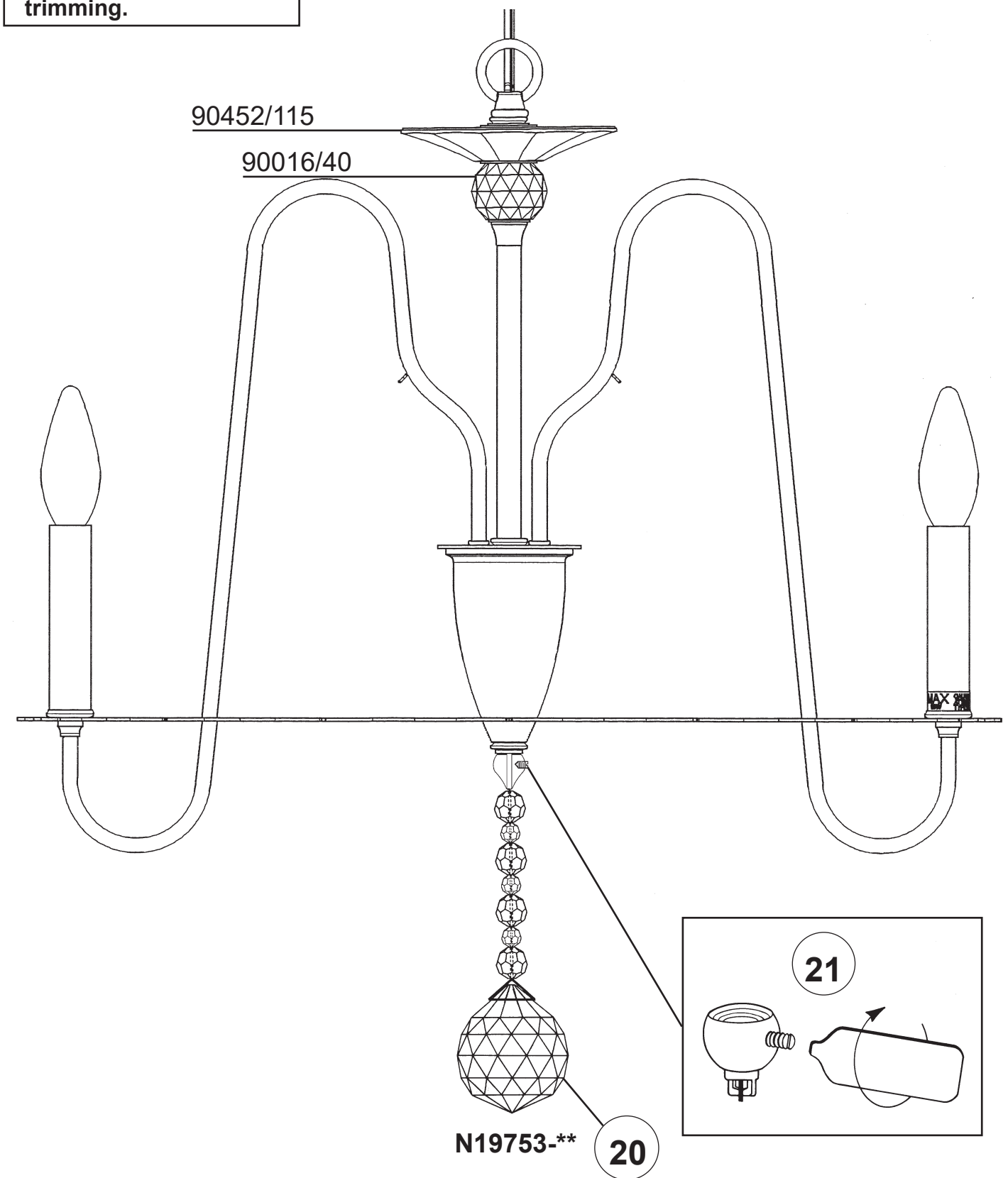

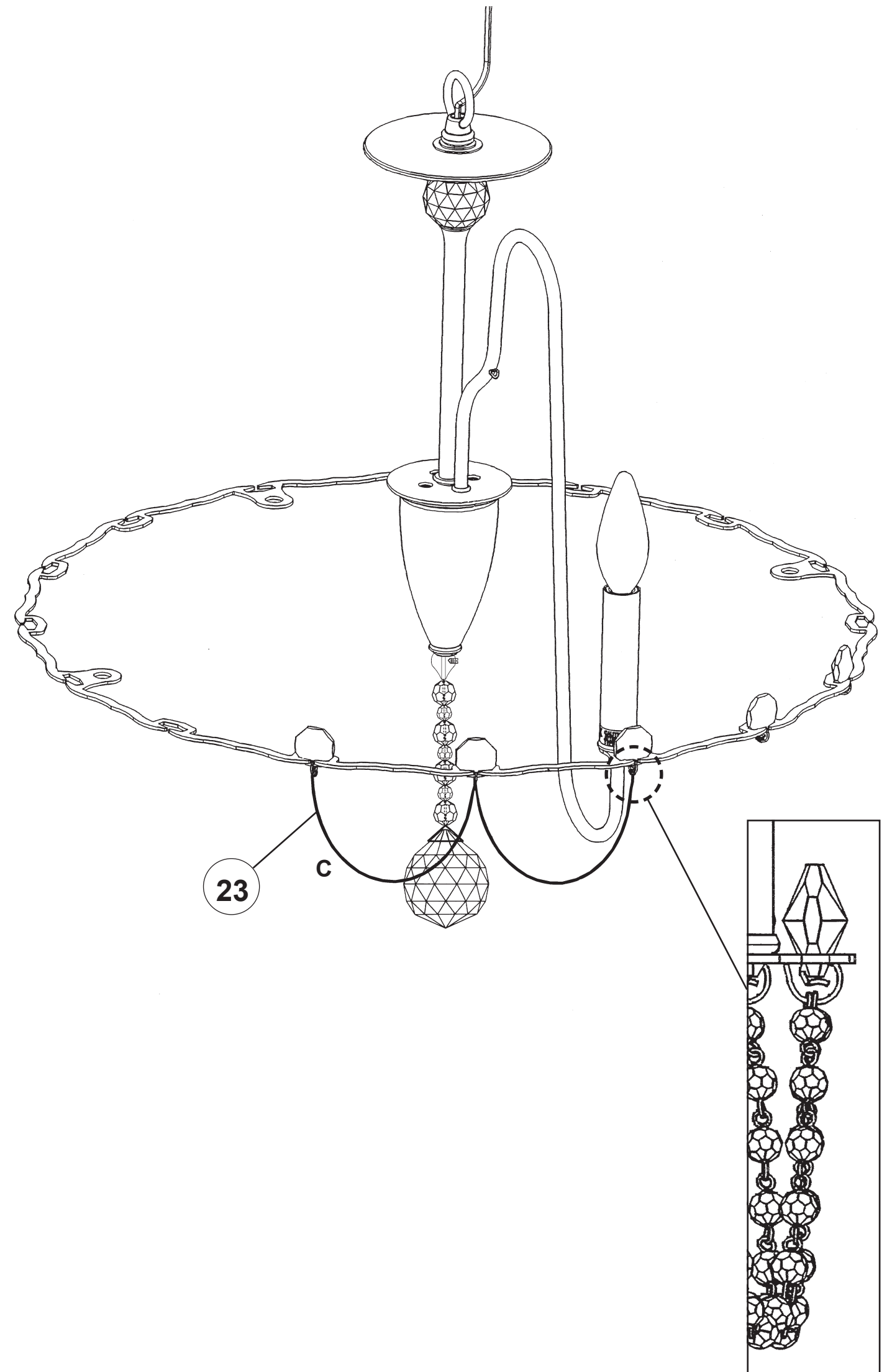
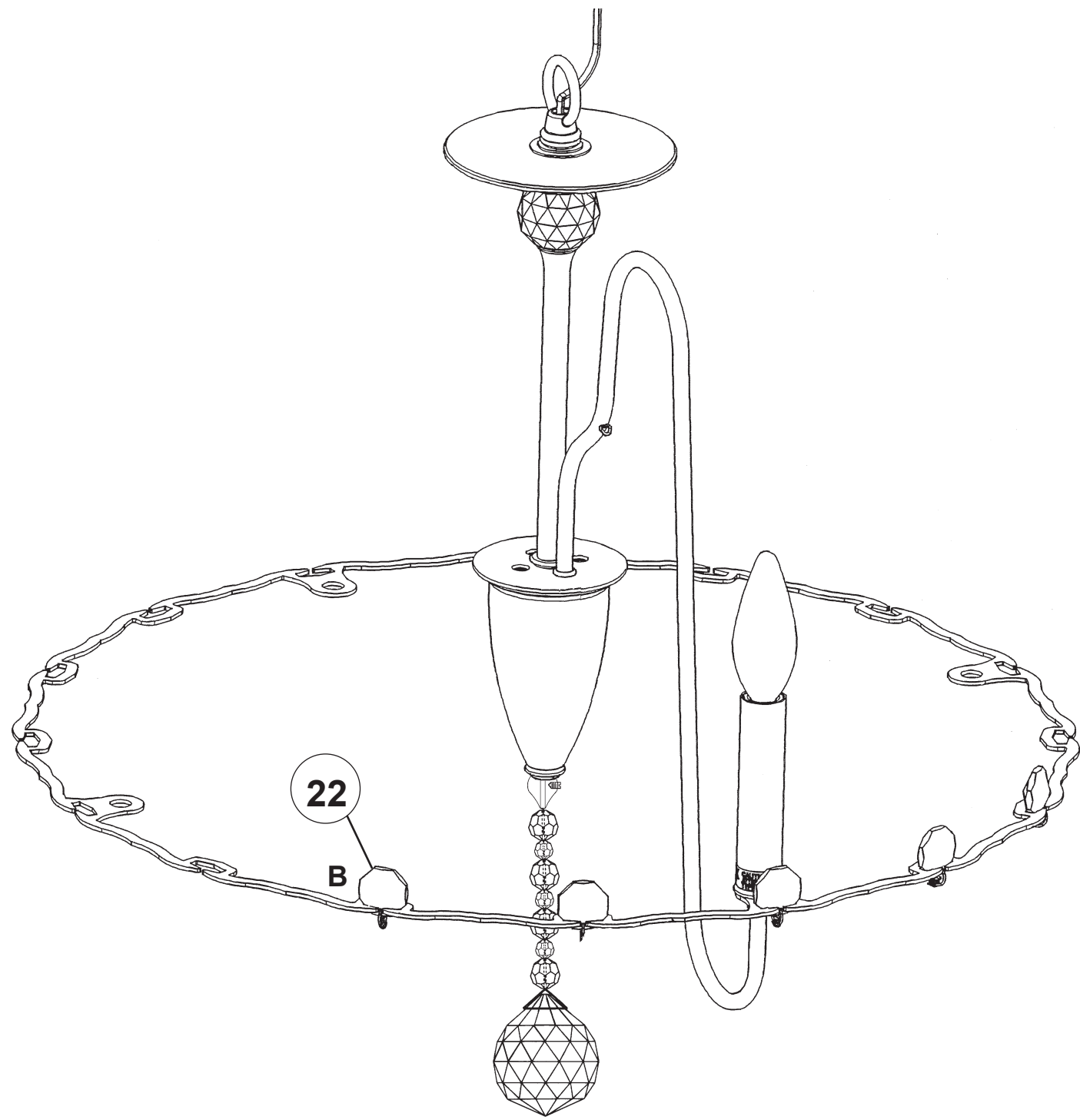

 **SCHONBEK** | 1870











ESMERY AR1004N-__ __S



THIS DESIGN IS THE PROPRIETARY
TRADE DRESS/TRADEMARK OF
W SCHONBEK LLC.

4 Lights
Diameter: 21"
Height: 21-1/2"
Hanging Weight: 8lbs.

 **SCHONBEK** | 1870

								
MAX <u>60</u> W	110-120 V							

WARNING:

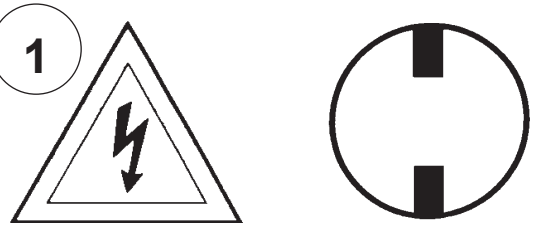
1 

Electrical Danger Turn Power Off

All electrical components must be installed by a licensed electrician in accordance with the National Electric Code and the appropriate local electrical codes.

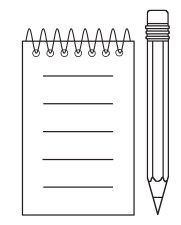
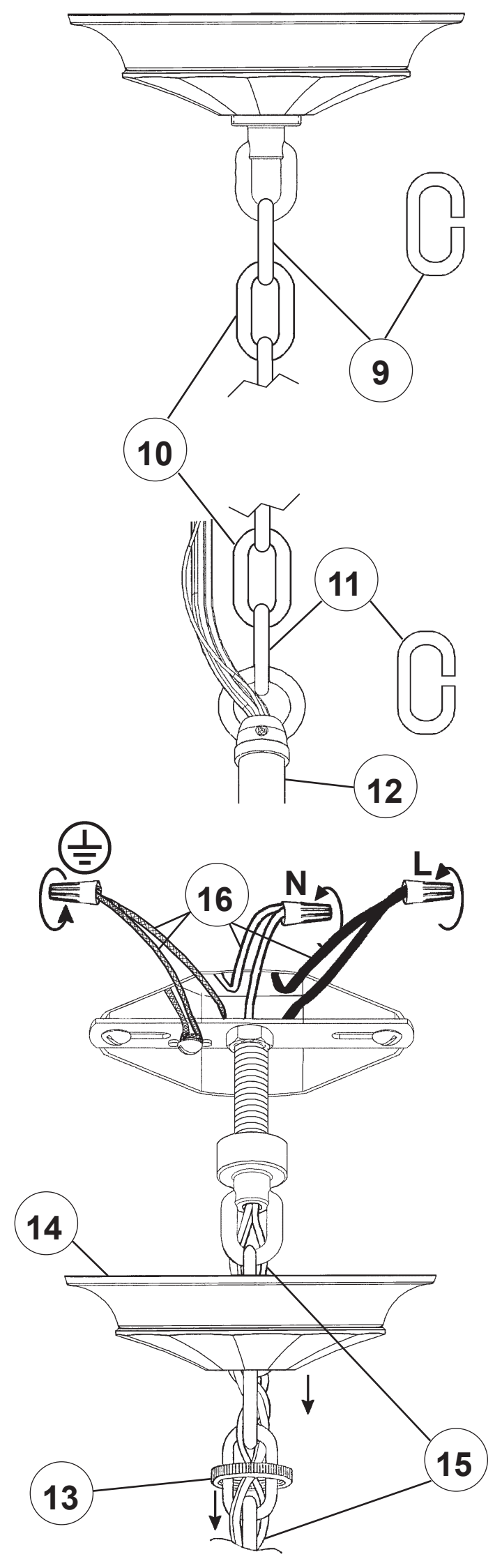
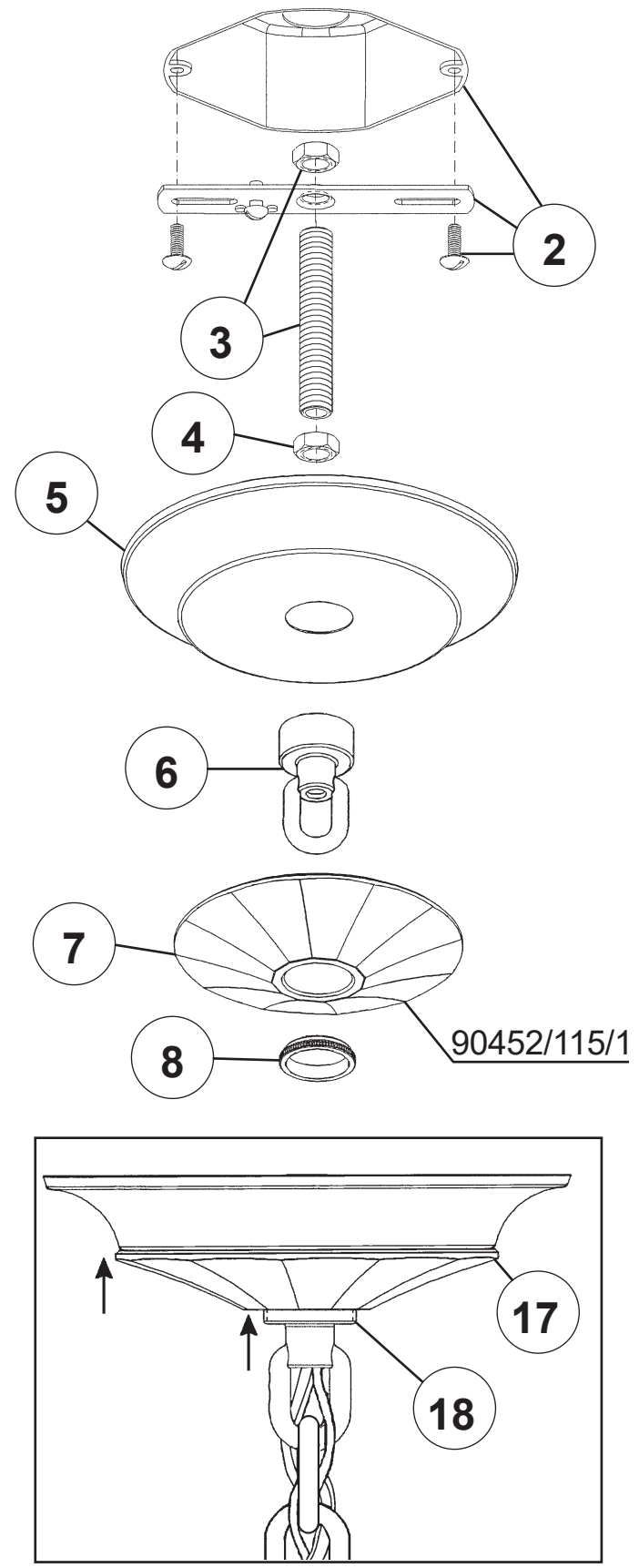

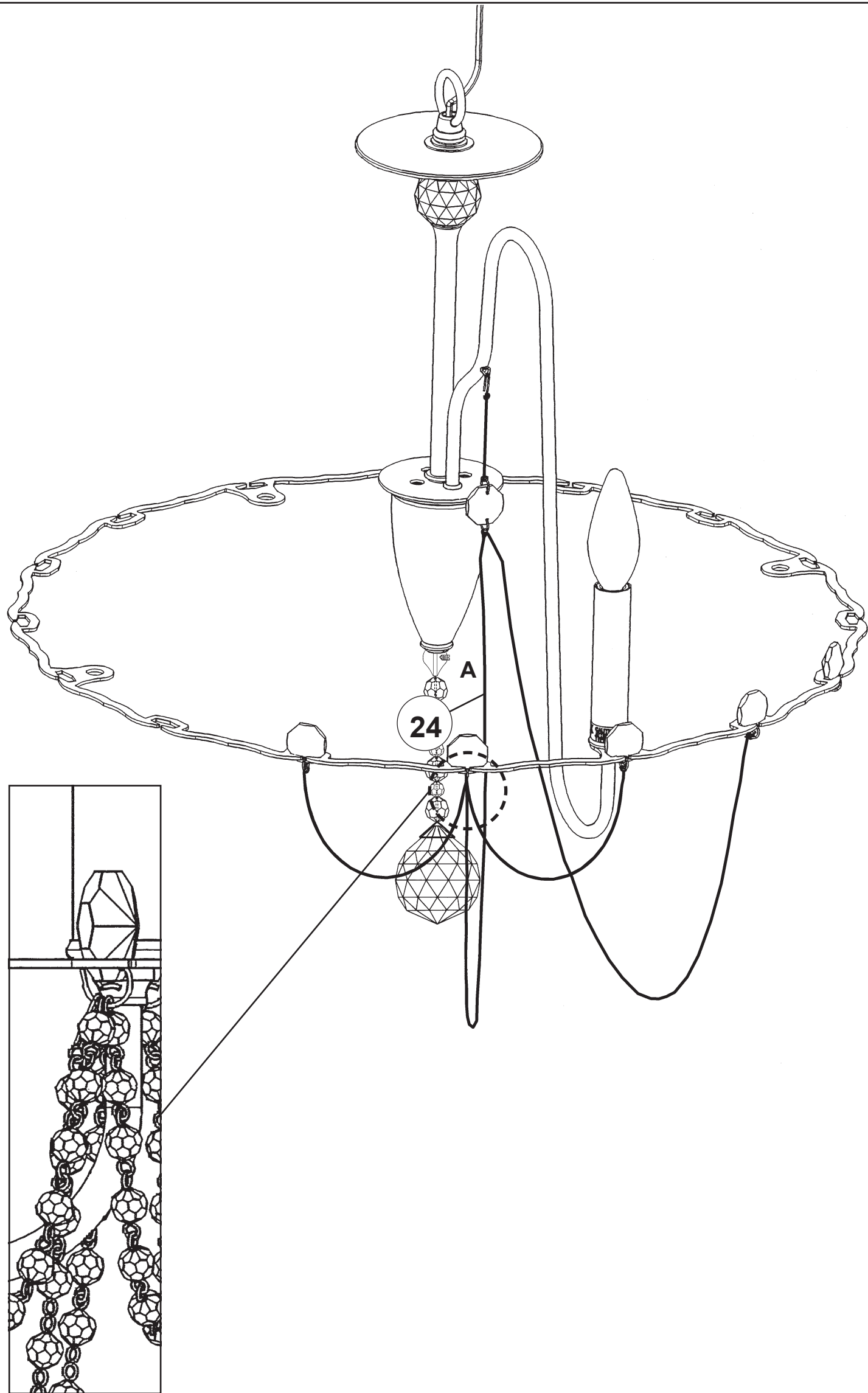

19

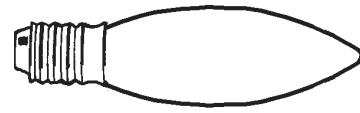

You will need 4 - B10
25 Watts Recommended
60 Watts Max

**Install bulbs and be sure
to test fixture BEFORE
trimming.**

