

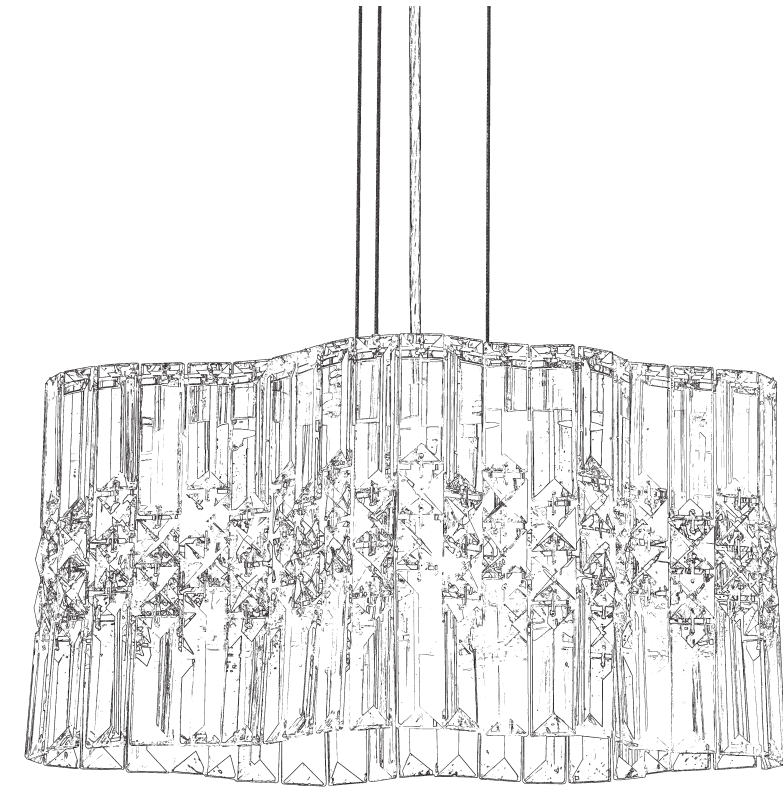

 **SCHONBEK** | 1870

SELENE
SPU120N- _ _ _ O

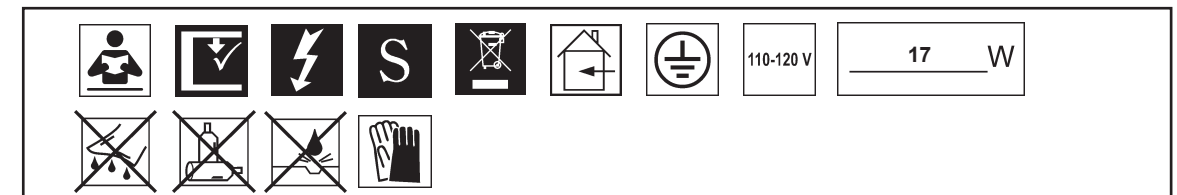

 **SCHONBEK** | 1870



3 X  : 30561/12

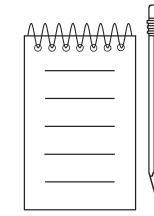
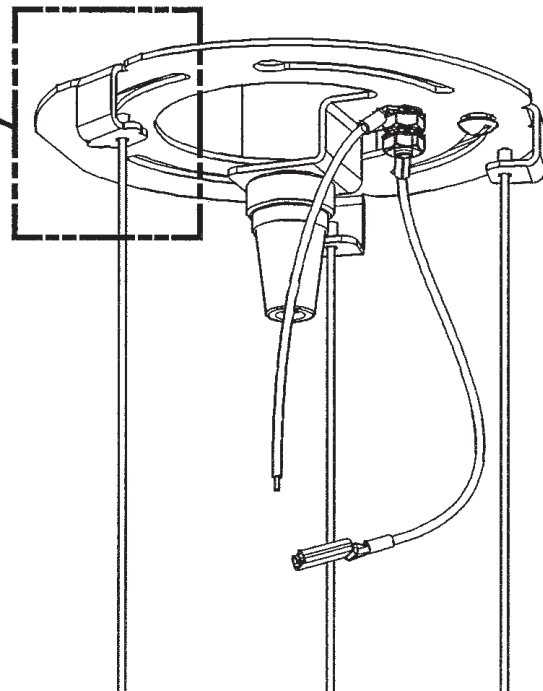
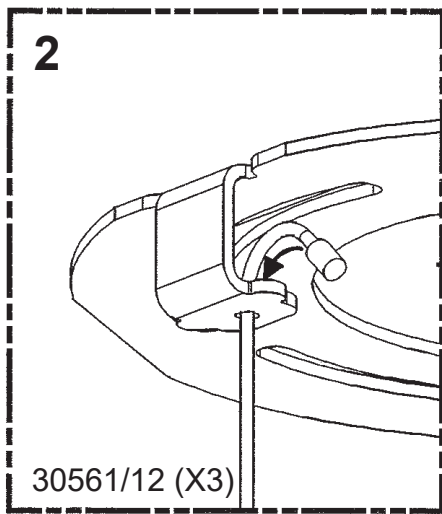
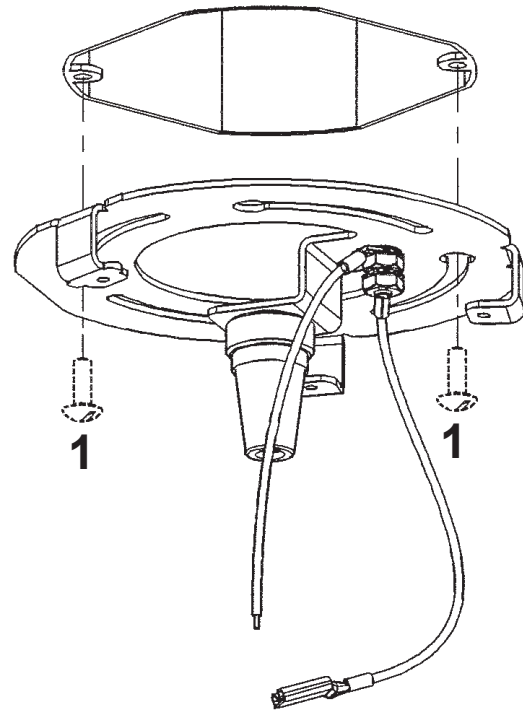

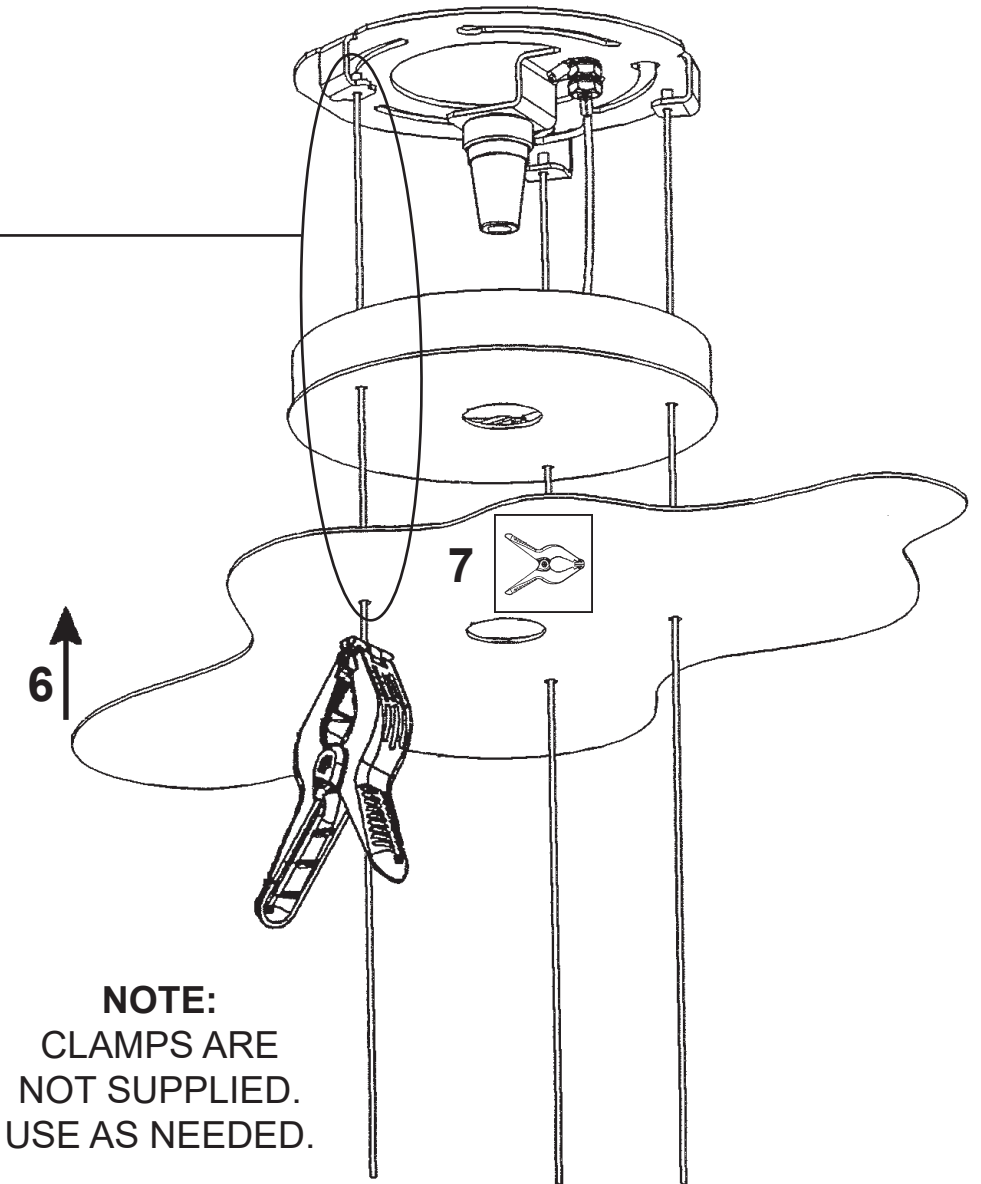
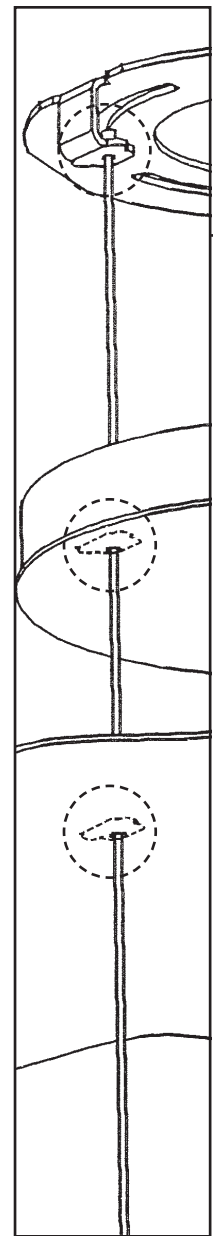
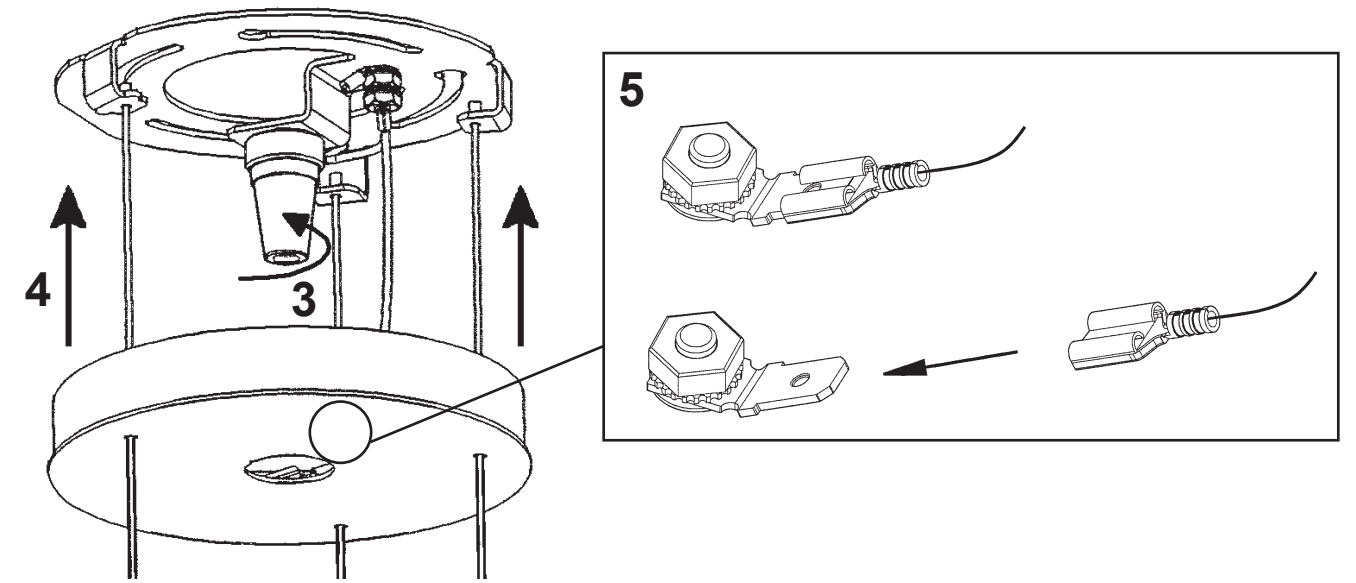
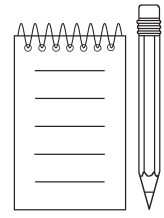

NOTE:
CLAMPS ARE
NOT SUPPLIED.
USE AS NEEDED.

