

TRILLIANE 5876- __ _ H

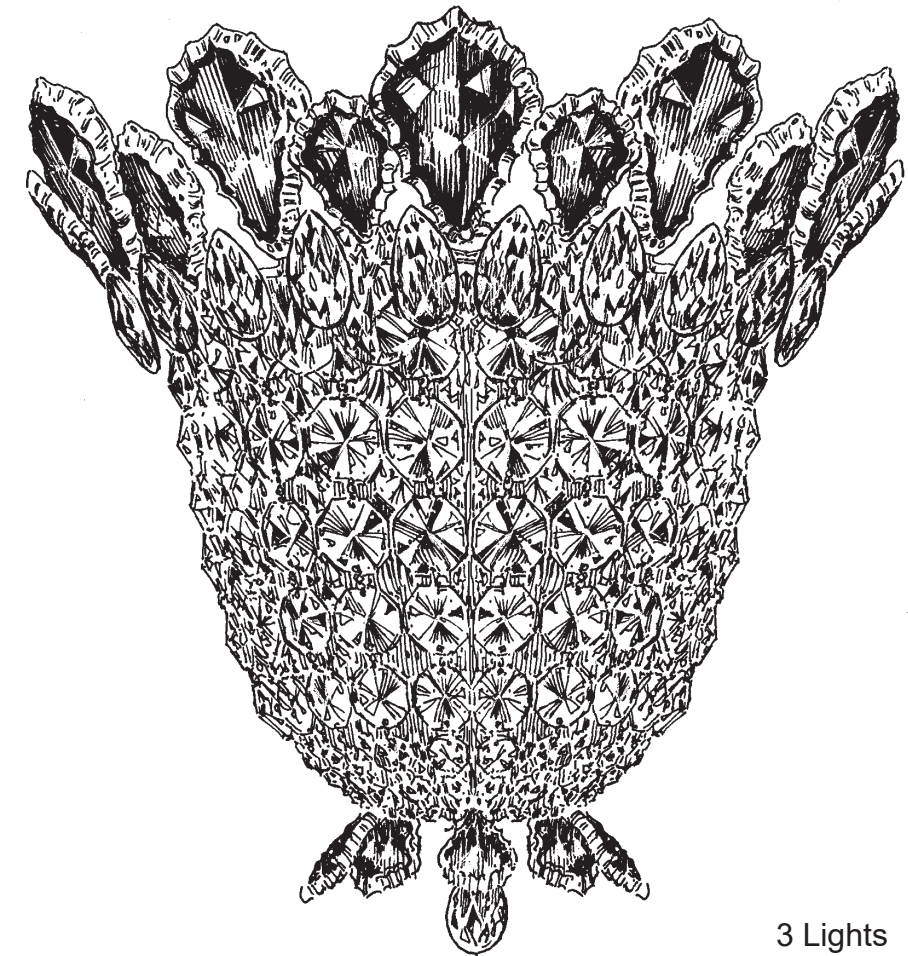











3 Lights
Diameter: 11-1/2"
Body Length: 10-1/2"
Extension: 6"
Hanging Weight: 5 lbs.

THIS DESIGN IS THE PROPRIETARY
TRADE DRESS/TRADEMARK OF
W SCHONBEK LLC.

 **SCHONBEK** | 1870

 **SCHONBEK** | 1870

								
MAX 40 W		110-120 V						

All electrical components must be installed by a licensed electrician in accordance with the National Electric Code and the appropriate local electrical codes.

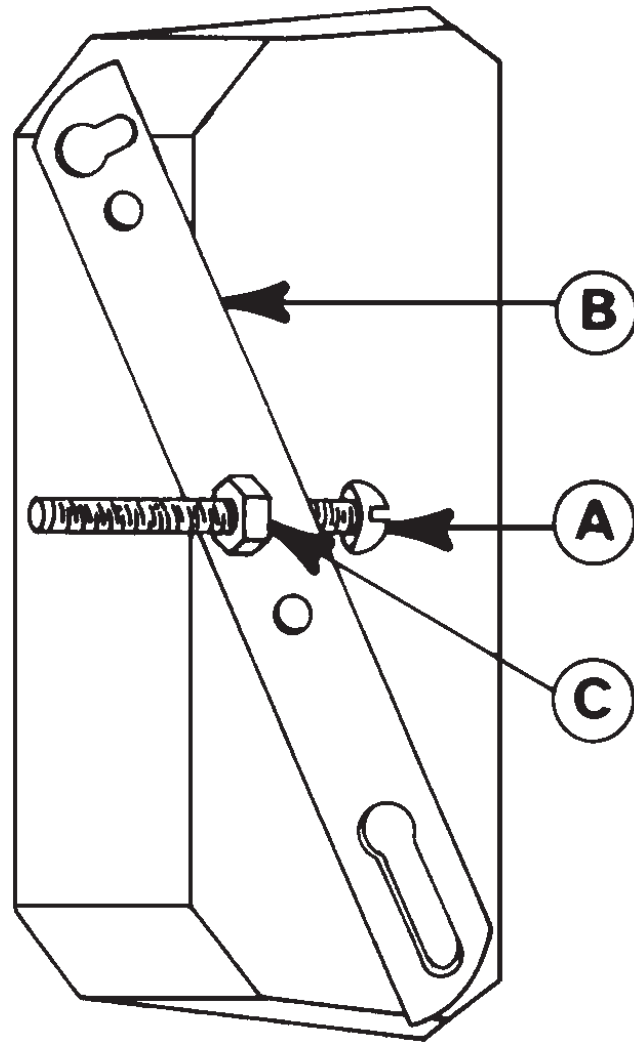

1 MAKE SURE THAT POWER TO THE OUTLET BOX IS DISCONNECTED!!

2 Thread long screw "A" through crossbar "B" and attach crossbar to outlet box using 2 screws round head 8-32 x 1" (not supplied with wall bracket.)

3 Test fit wall bracket by guiding it over screw "A". Adjust screw "A" so that it extends approximately 1/4" through wall bracket. Remove wall bracket. Thread nut "C" onto screw and tighten it against crossbar. (NOTE: In some installations, due to space, nut "C" might have to go on the other side of the crossbar.)

4 Connect the wires of the wall bracket to the power wires of the outlet box, guide wall bracket over screw "A" and secure with threaded half ball supplied.

5 Make sure wall bracket is level. Upper portion of wall bracket must be secured to the wall. Screw mounting screw through hole near ring #1 and by bottom finial until mirror touches wall. NOTE: Fixture MUST be grounded.

6 Screw bulbs into all sockets(s). Test power to insure proper wiring before hanging trim from fixture.

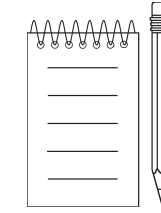

Installation of Crystal "H"

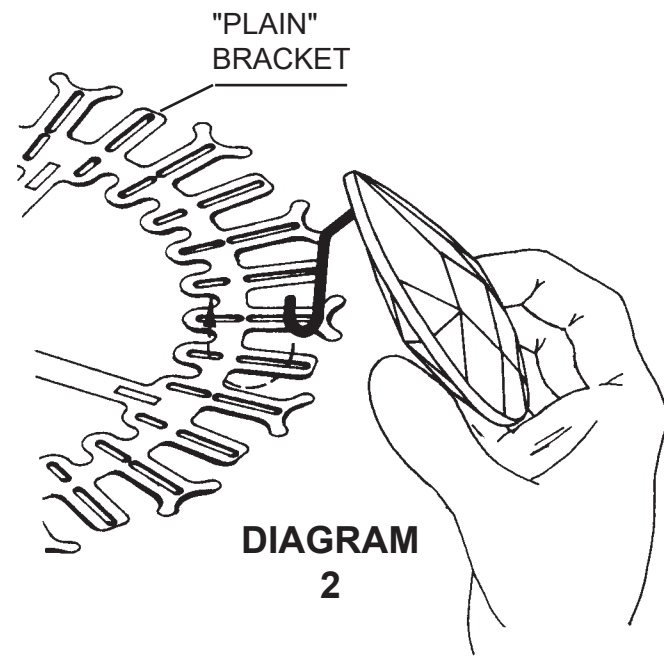

Position the crystal above the "plain" bracket so that the end of the hook enters the slot, gently push toward the center of the fixture and raise the crystal making sure that the end of the hook comes up through the inner slot, in line with the outer slot.

With the hook in the bracket, as shown, pivot the crystal downwards so that the hook rests in the end of the outer slot.



Installation of Crystal "C" and "D"

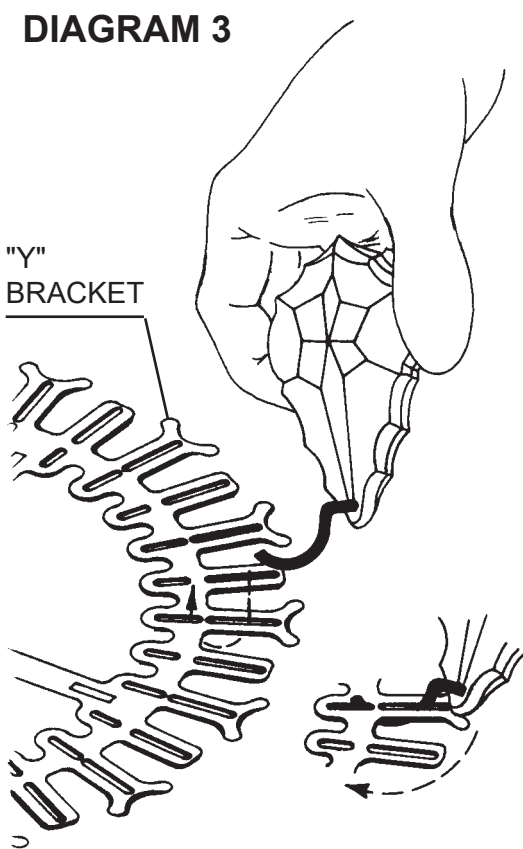

Position the crystal above the "Y" bracket so that the end of the hook enters the long slot, gently push toward the center of the fixture and raise the crystal making sure that the end of the hook comes up through the short slot, in line with the long slot.

With the hook in the bracket, as shown, pivot the crystal downwards so that the hook rests in the end of the long slot.

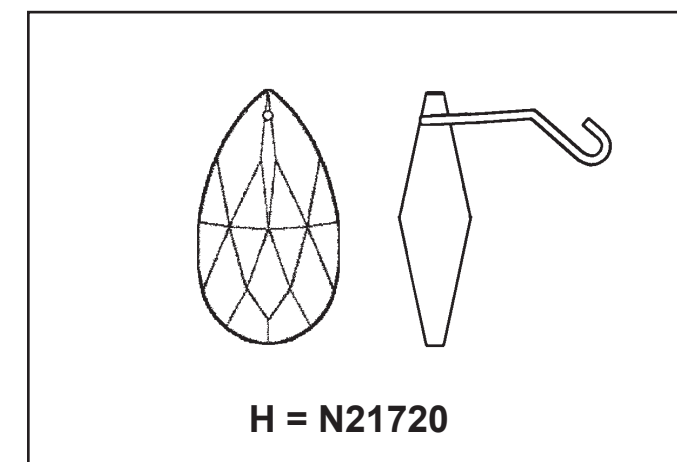
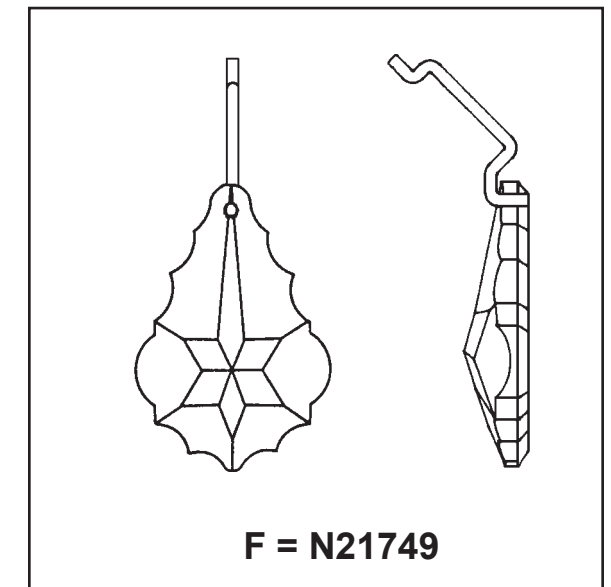
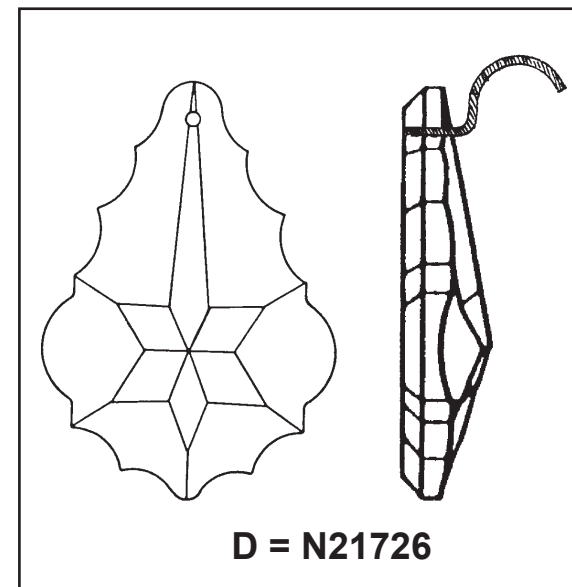
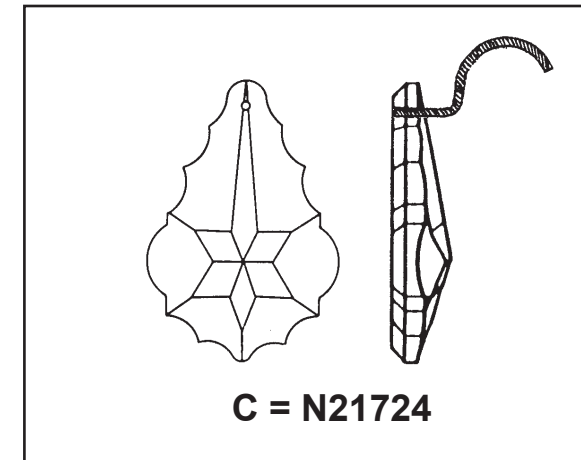



7

You will need 3 - B10
25 Watts Recommended
40 Watts Max

**Install bulbs and be sure
to test fixture BEFORE
trimming.**

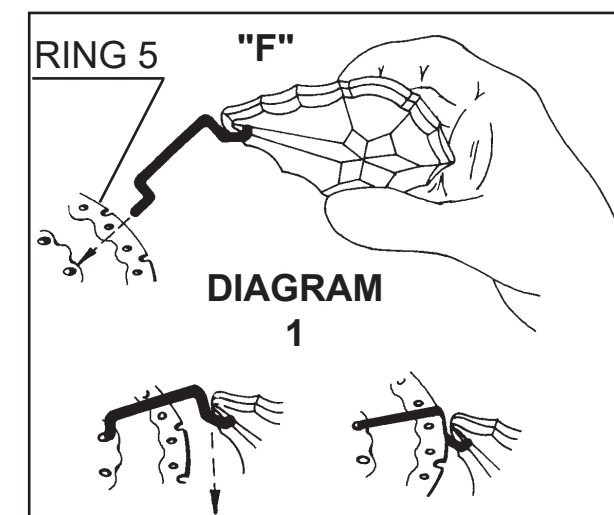

8 Hook Crystal Chain "E" into ring 4. See View "B"
Hook Crystal "F" into ring 5. (See diagram 1 for detailed
instructions.)

9 Hook the bottom of Chains "E" into the ring 5. Close
bottom hook after inserting into ring.

10 Hook Crystal Drop "G" into the knob located under
ring 5.

11 Hook Crystal "H" into the "plain" bracket of ring 3.
(See diagram 2 on page 6 for detailed instructions.)

12 Hook small Crystal "C" into every second "Y" bracket
of ring 3. NOTE: Start against wall. (See diagram 3 on page
6 for detailed instructions.)

13 Hook large Crystal "D" into the second
(remaining) "Y" brackets of ring 3. (See diagram 3 on page
6 for detailed instructions.)

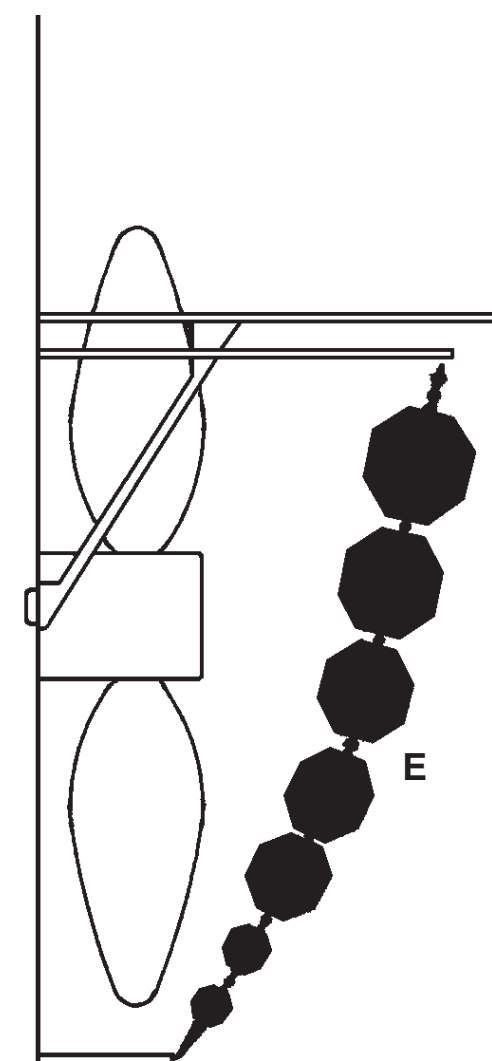
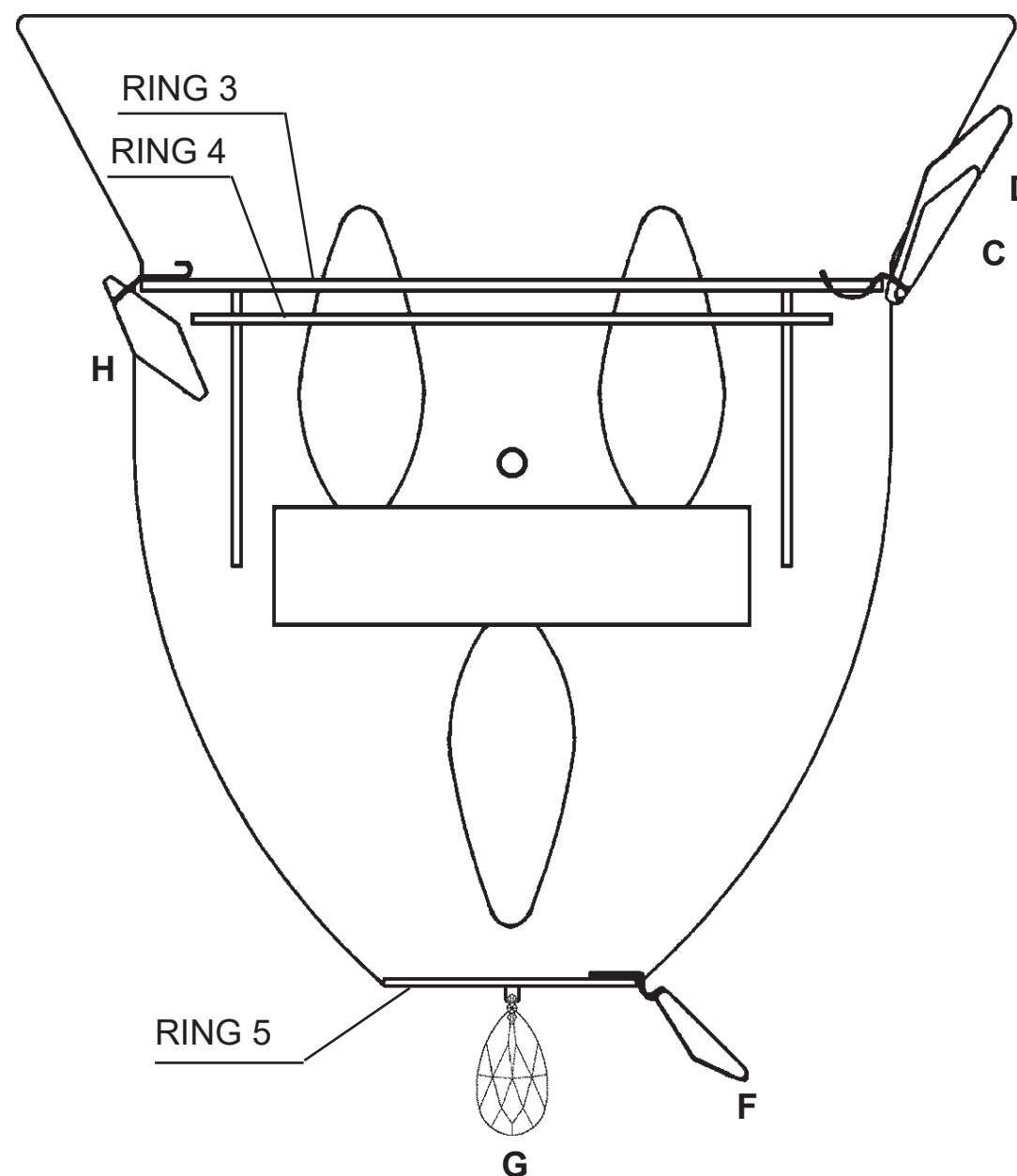

TRILLIANE 5876- __ _R

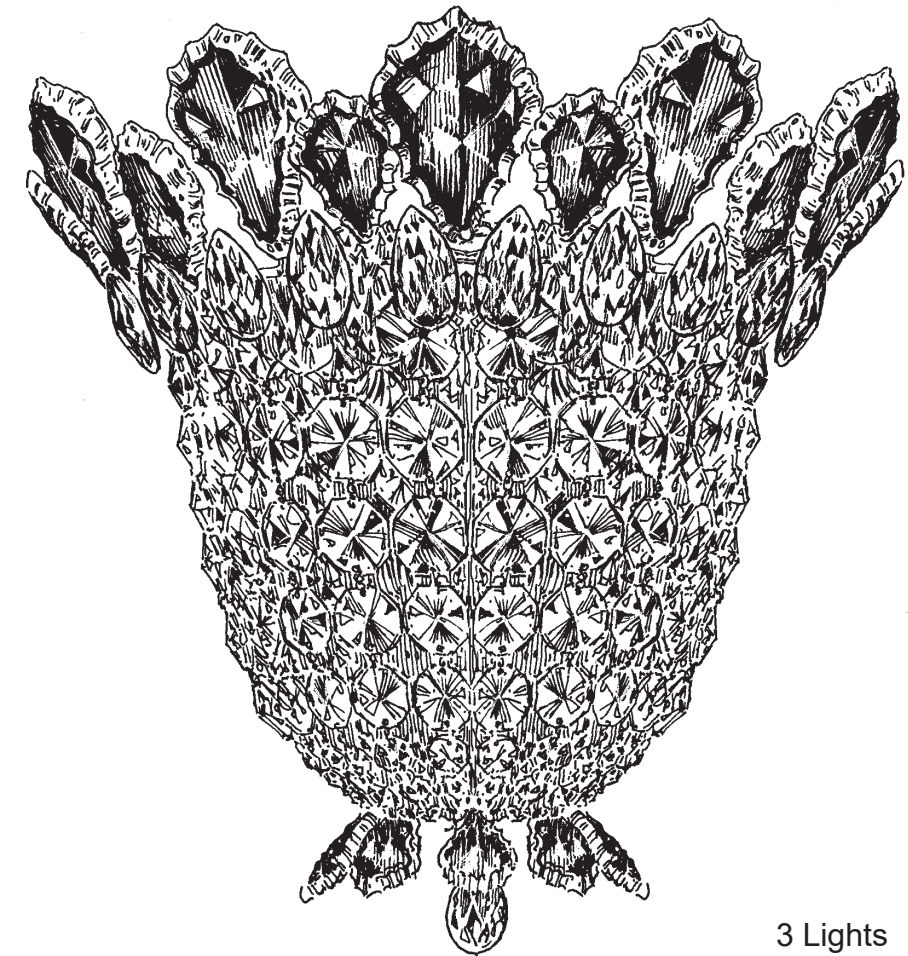











3 Lights
Diameter: 11-1/2"
Body Length: 10-1/2"
Extension: 6"
Hanging Weight: 5 lbs.

THIS DESIGN IS THE PROPRIETARY
TRADE DRESS/TRADEMARK OF
W SCHONBEK LLC.

 **SCHONBEK** | 1870

 **SCHONBEK** | 1870

								
MAX 40 W	110-120 V							

All electrical components must be installed by a licensed electrician in accordance with the National Electric Code and the appropriate local electrical codes.

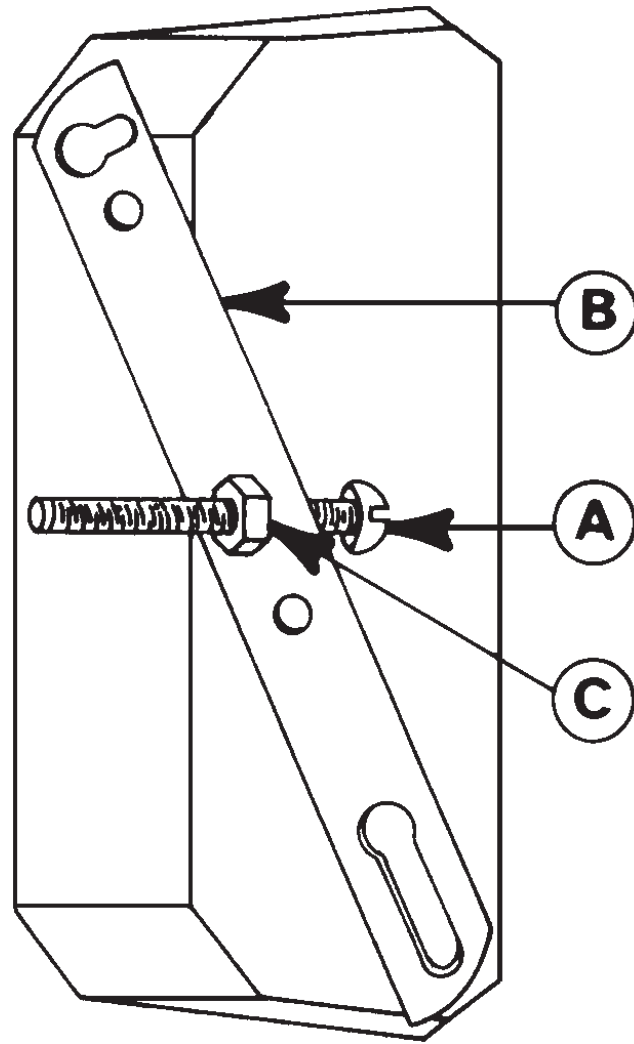

1 MAKE SURE THAT POWER TO THE OUTLET BOX IS DISCONNECTED!!

2 Thread long screw "A" through crossbar "B" and attach crossbar to outlet box using 2 screws round head 8-32 x 1" (not supplied with wall bracket.)

3 Test fit wall bracket by guiding it over screw "A". Adjust screw "A" so that it extends approximately 1/4" through wall bracket. Remove wall bracket. Thread nut "C" onto screw and tighten it against crossbar. (NOTE: In some installations, due to space, nut "C" might have to go on the other side of the crossbar.)

4 Connect the wires of the wall bracket to the power wires of the outlet box, guide wall bracket over screw "A" and secure with threaded half ball supplied.

5 Make sure wall bracket is level. Upper portion of wall bracket must be secured to the wall. Screw mounting screw through hole near ring #1 and by bottom finial until mirror touches wall. NOTE: Fixture MUST be grounded.

6 Screw bulbs into all sockets(s). Test power to insure proper wiring before hanging trim from fixture.

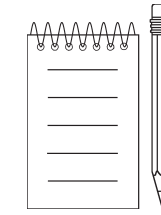

Installation of Crystal "H"

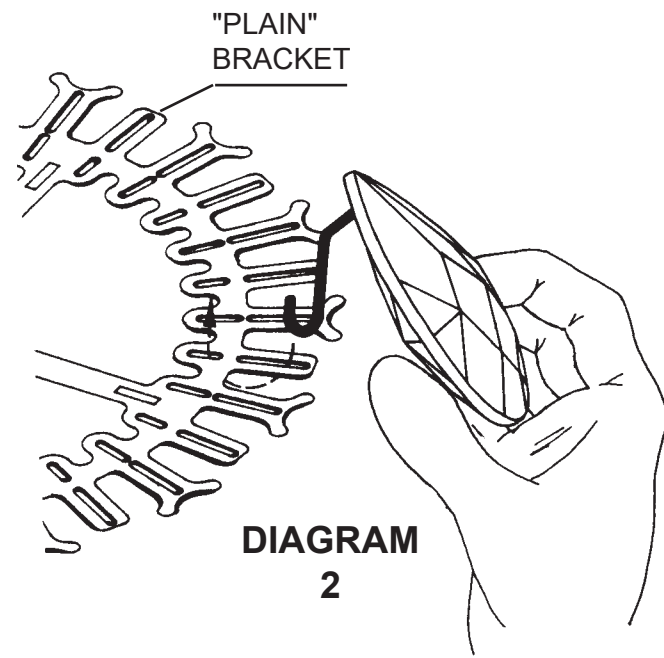

Position the crystal above the "plain" bracket so that the end of the hook enters the slot, gently push toward the center of the fixture and raise the crystal making sure that the end of the hook comes up through the inner slot, in line with the outer slot.

With the hook in the bracket, as shown, pivot the crystal downwards so that the hook rests in the end of the outer slot.



Installation of Crystal "C" and "D"

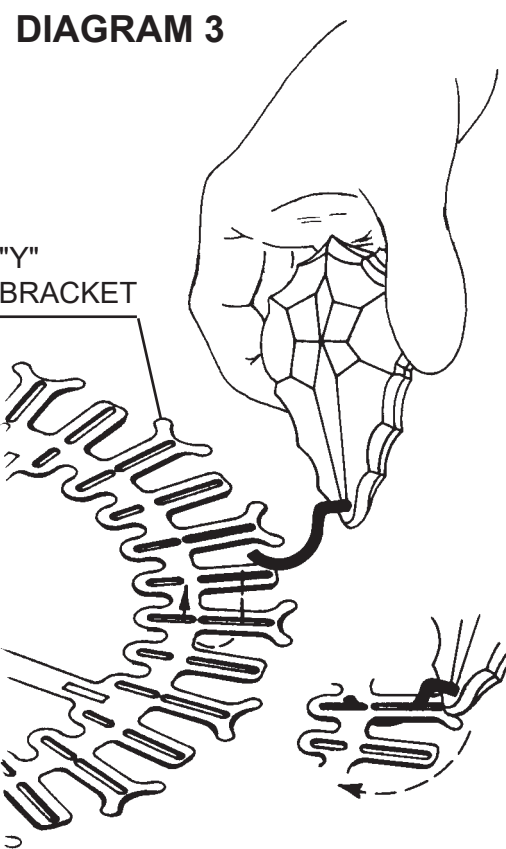

Position the crystal above the "Y" bracket so that the end of the hook enters the long slot, gently push toward the center of the fixture and raise the crystal making sure that the end of the hook comes up through the short slot, in line with the long slot.

With the hook in the bracket, as shown, pivot the crystal downwards so that the hook rests in the end of the long slot.

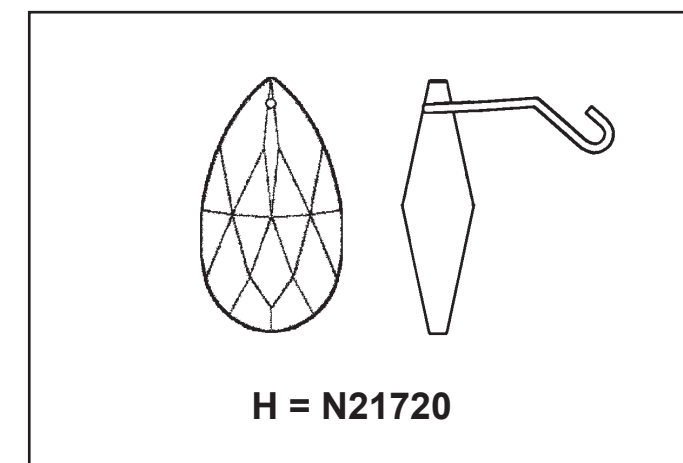
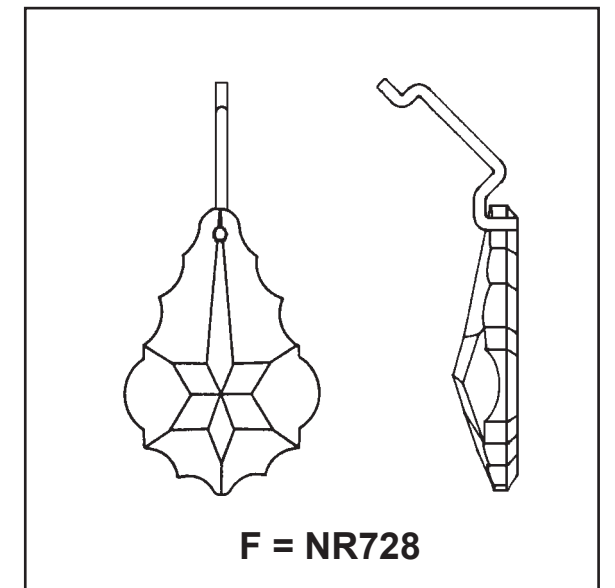
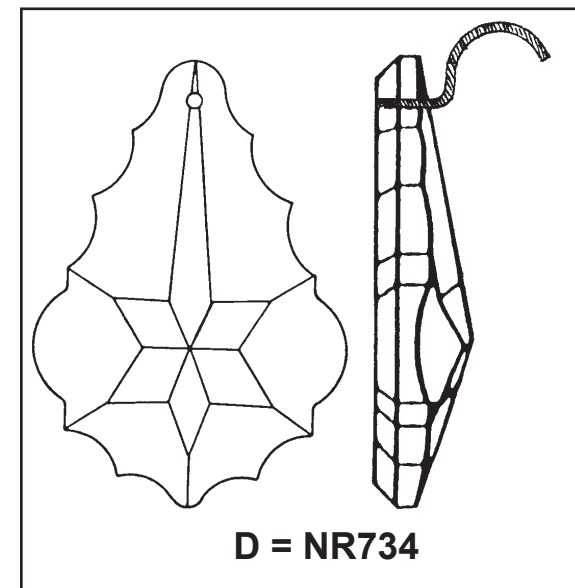
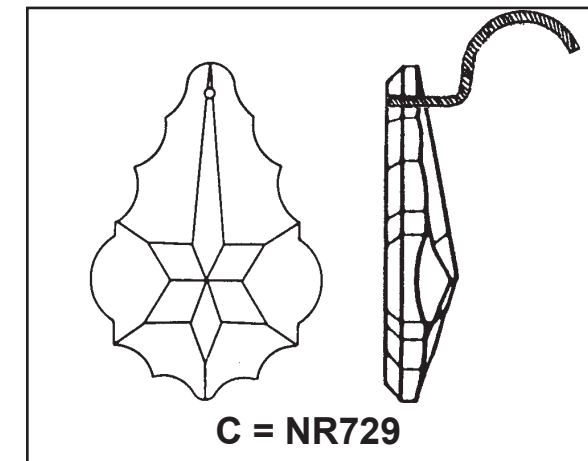



7

You will need 3 - B10
25 Watts Recommended
40 Watts Max

**Install bulbs and be sure
to test fixture BEFORE
trimming.**

8 Hook Crystal Chain "E" into ring 4. See View "B"
Hook Crystal "F" into ring 5. (See diagram 1 for detailed
instructions.)

9 Hook the bottom of Chains "E" into the ring 5. Close
bottom hook after inserting into ring.

10 Hook Crystal Drop "G" into the knob located under
ring 5.

11 Hook Crystal "H" into the "plain" bracket of ring 3.
(See diagram 2 on page 6 for detailed instructions.)

12 Hook small Crystal "C" into every second "Y" bracket
of ring 3. NOTE: Start against wall. (See diagram 3 on page
6 for detailed instructions.)

13 Hook large Crystal "D" into the second
(remaining) "Y" brackets of ring 3. (See diagram 3 on page
6 for detailed instructions.)

