

NOUVEAU RENAISSANCE RN3871N-__ __H

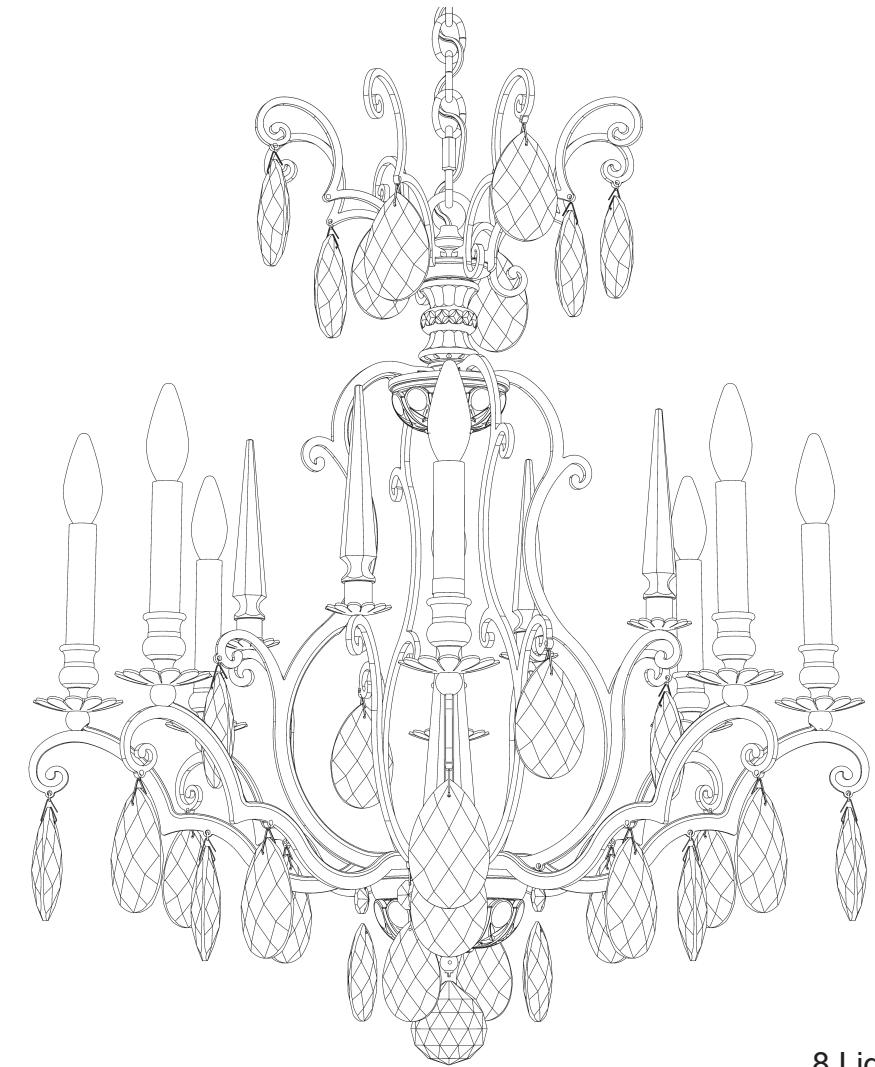











8 Lights
Diameter: 26-1/2"
Body Length: 31"
Hanging Weight: 31lbs.

THIS DESIGN IS THE PROPRIETARY
TRADE DRESS/TRADEMARK OF
W SCHONBEK LLC.

 **SCHONBEK** | 1870

 **SCHONBEK** | 1870

								
MAX 60 W	110-120 V							

All electrical components must be installed by a licensed electrician in accordance with the National Electric Code and the appropriate local electrical codes.

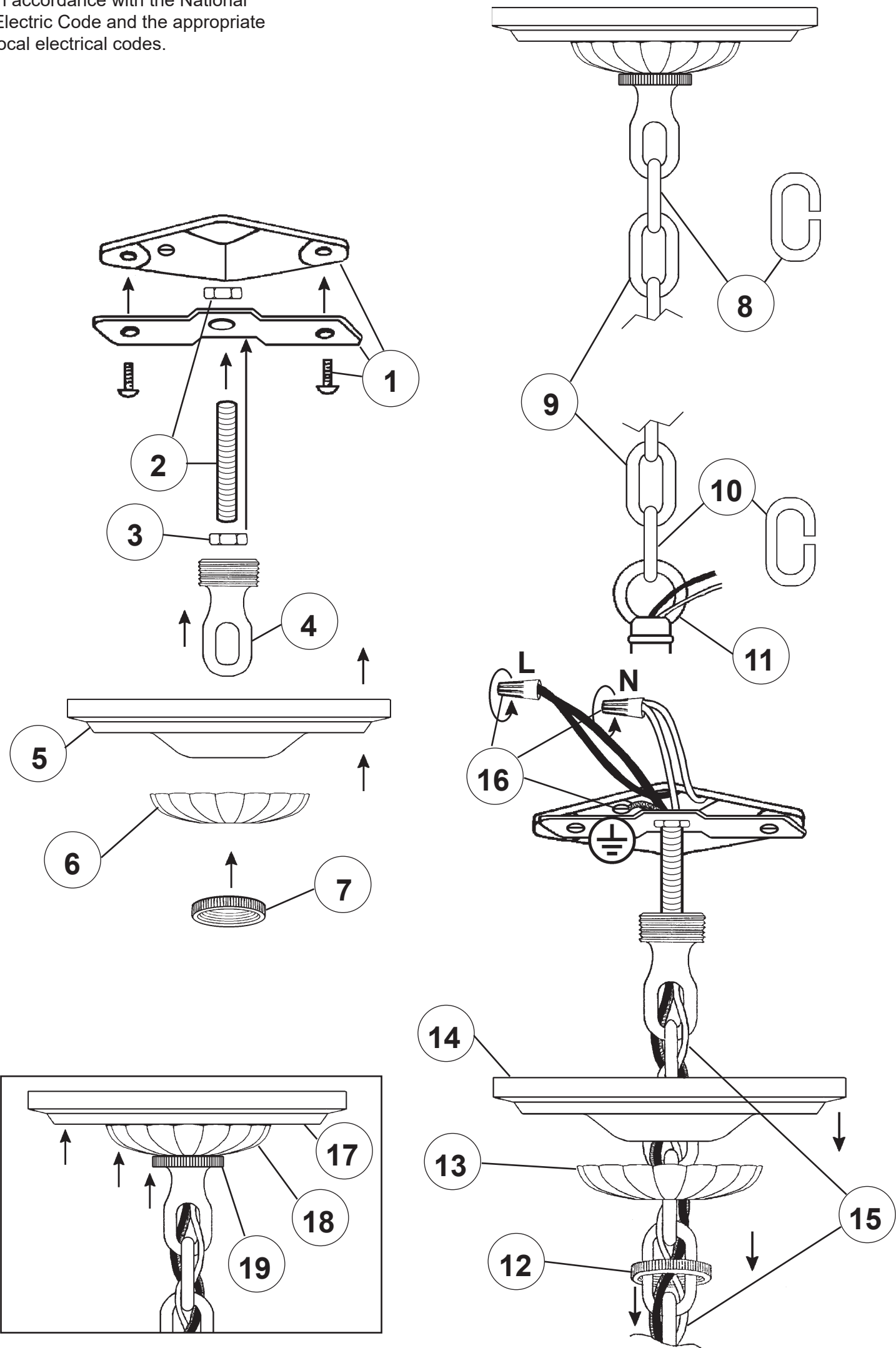

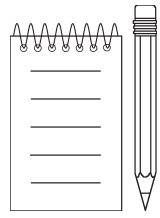

SET 1

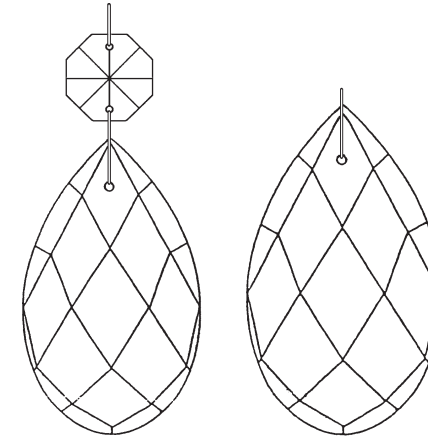

N4000
3"
76mm

N4001
3-1/2"
89mm

SET 2

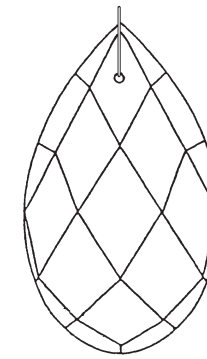

N4001
3-1/2"
89mm

20



You will need 8 - B10
25 Watts Recommended
60 Watts Max

Install bulbs and be sure
to test fixture **BEFORE**
trimming.

1 X : 400/16-**

Crystal Set 1 in Black

Crystal Set 2 in Black

