

NEW ORLEANS 3648- ___ _H













4 Lights
Diameter: 12"
Body Length: 16-1/2"
Hanging Weight: 4 lbs.

THIS DESIGN IS THE PROPRIETARY
TRADE DRESS/TRADEMARK OF
W SCHONBEK LLC.

 **SCHONBEK** | 1870

 **SCHONBEK** | 1870

								
MAX 60 W		110-120 V						

All electrical components must be installed by a licensed electrician in accordance with the National Electric Code and the appropriate local electrical codes.

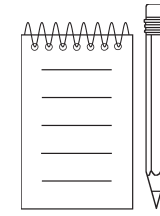
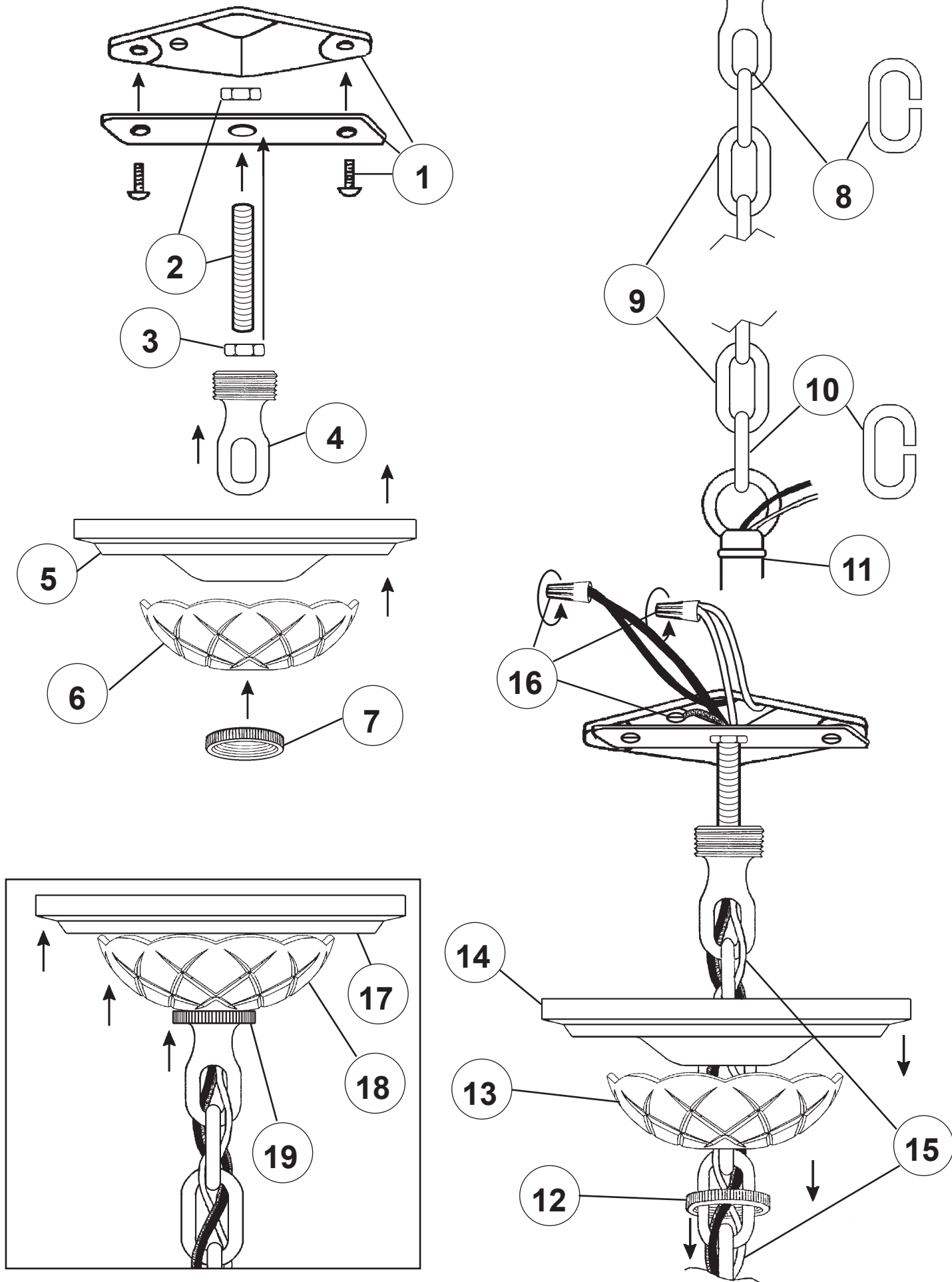



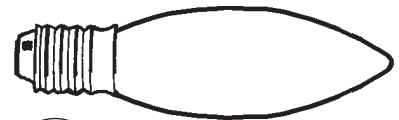

20

You will need 4 - B10
25 Watts Recommended
60 Watts Max

**Install bulb and be sure
to test fixture BEFORE
trimming.**

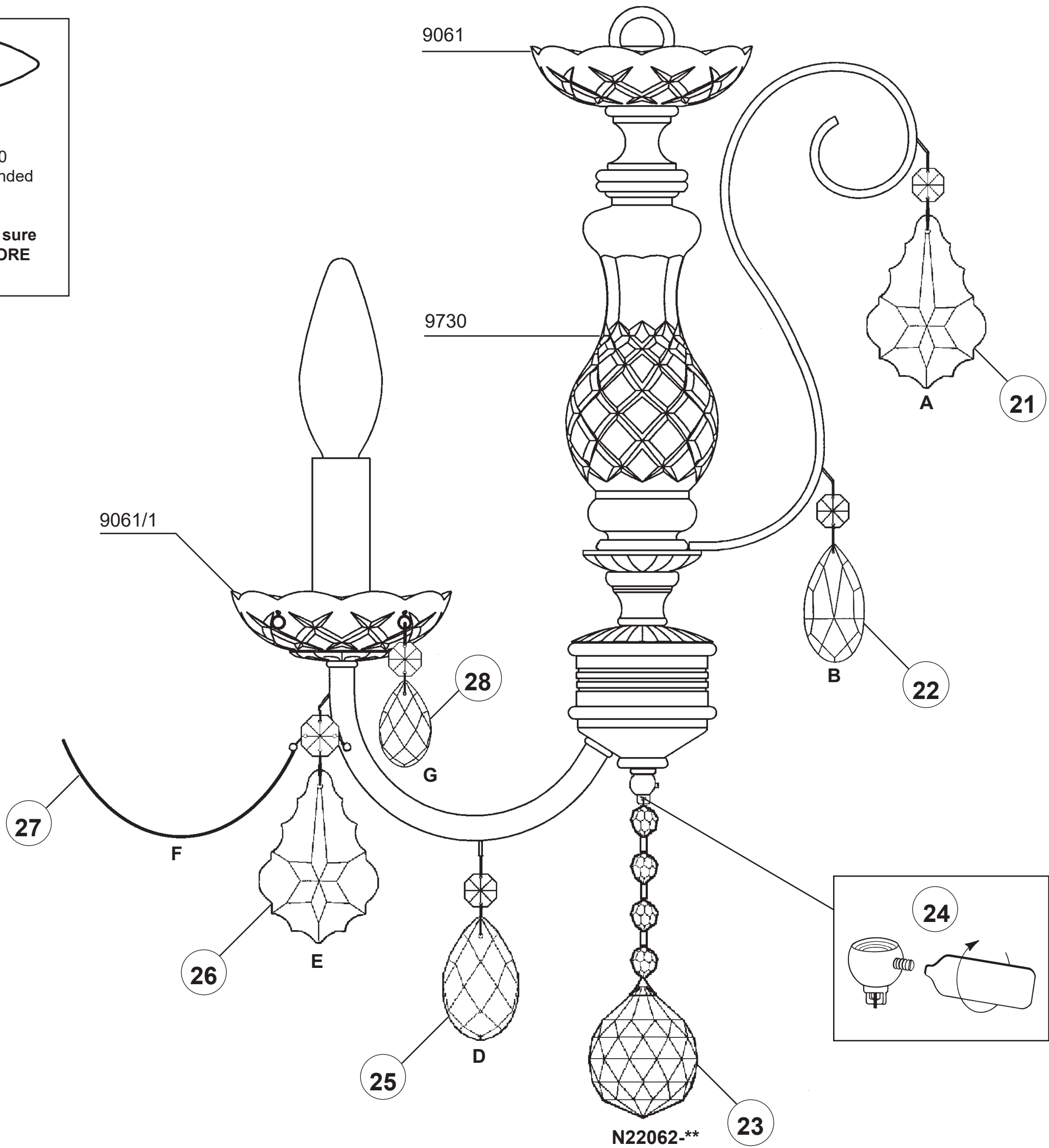

NEW ORLEANS 3648- __ __ R













4 Lights
Diameter: 12"
Body Length: 16-1/2"
Hanging Weight: 4 lbs.

THIS DESIGN IS THE PROPRIETARY
TRADE DRESS/TRADEMARK OF
W SCHONBEK LLC.

 **SCHONBEK** | 1870

 **SCHONBEK** | 1870

								
MAX 60 W		110-120 V						

All electrical components must be installed by a licensed electrician in accordance with the National Electric Code and the appropriate local electrical codes.

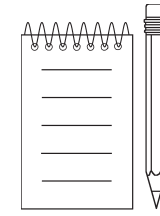
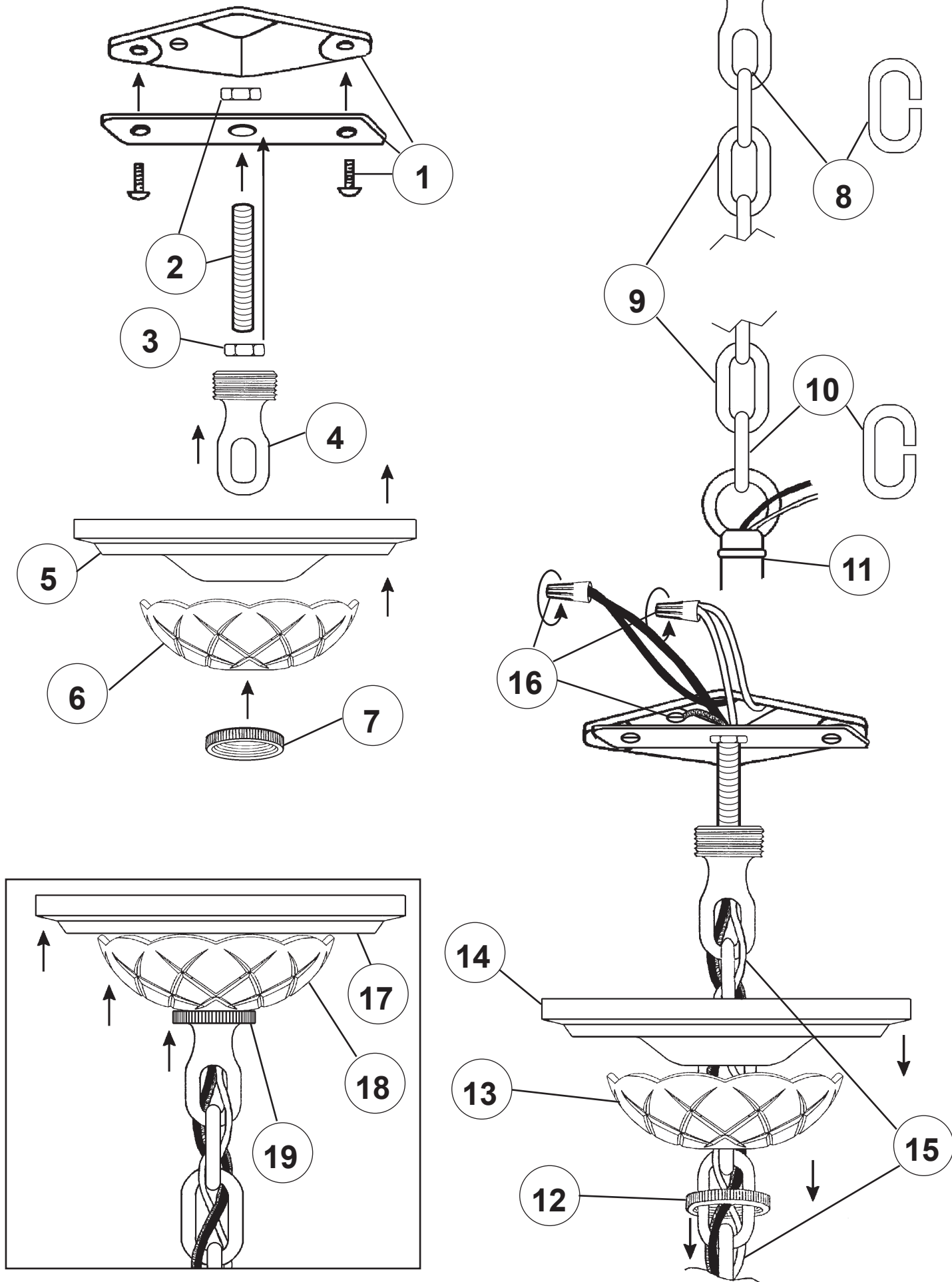

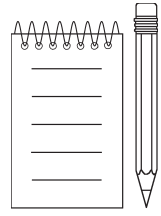

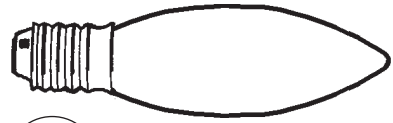

20

You will need 4 - B10
25 Watts Recommended
60 Watts Max

Install bulb and be sure
to test fixture **BEFORE**
trimming.

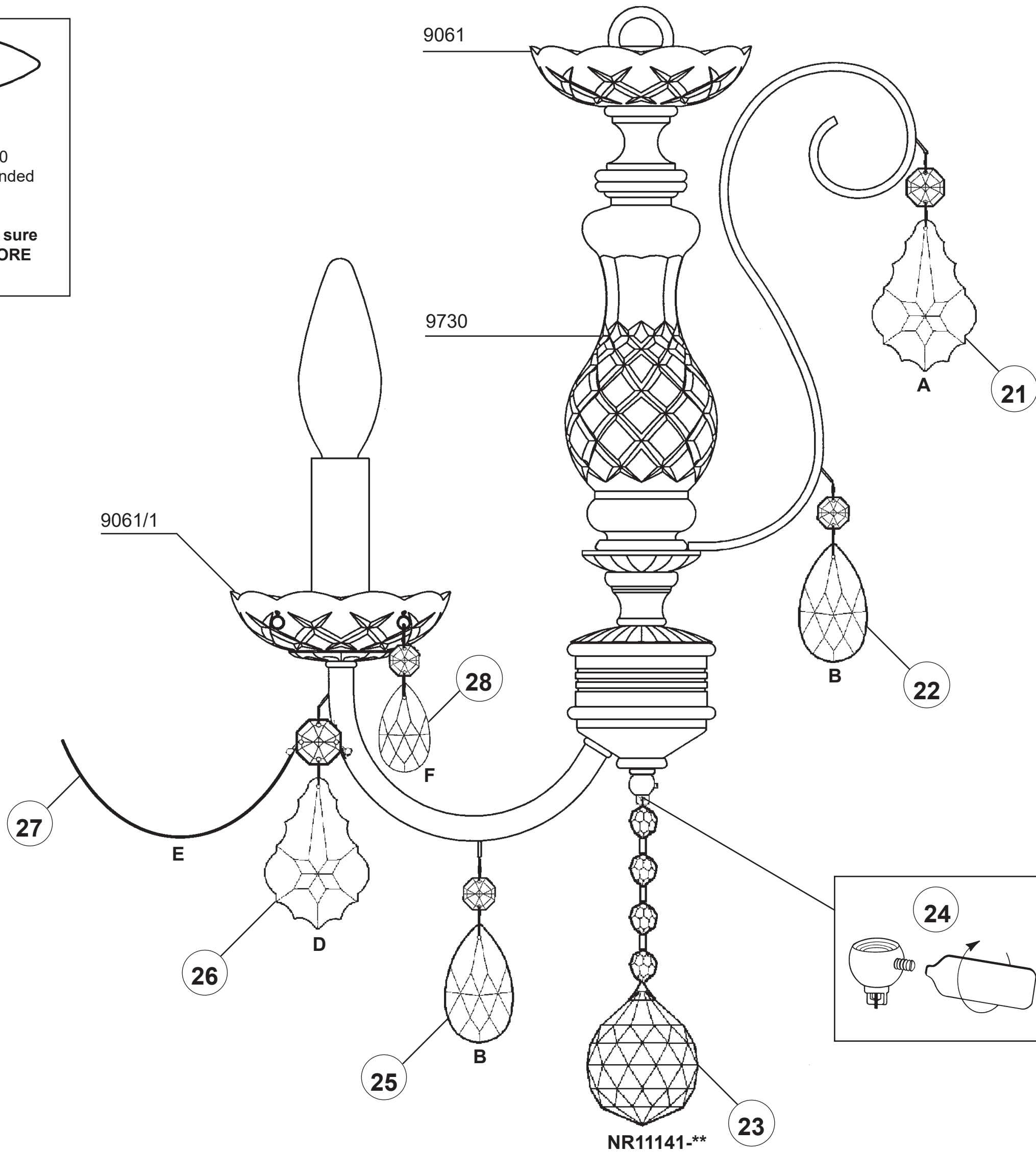

NEW ORLEANS 3648- ___ _S













4 Lights
Diameter: 12"
Body Length: 16-1/2"
Hanging Weight: 4 lbs.

THIS DESIGN IS THE PROPRIETARY
TRADE DRESS/TRADEMARK OF
W SCHONBEK LLC.

 **SCHONBEK** | 1870

 **SCHONBEK** | 1870

								
MAX 60 W		110-120 V						

All electrical components must be installed by a licensed electrician in accordance with the National Electric Code and the appropriate local electrical codes.

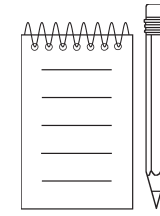
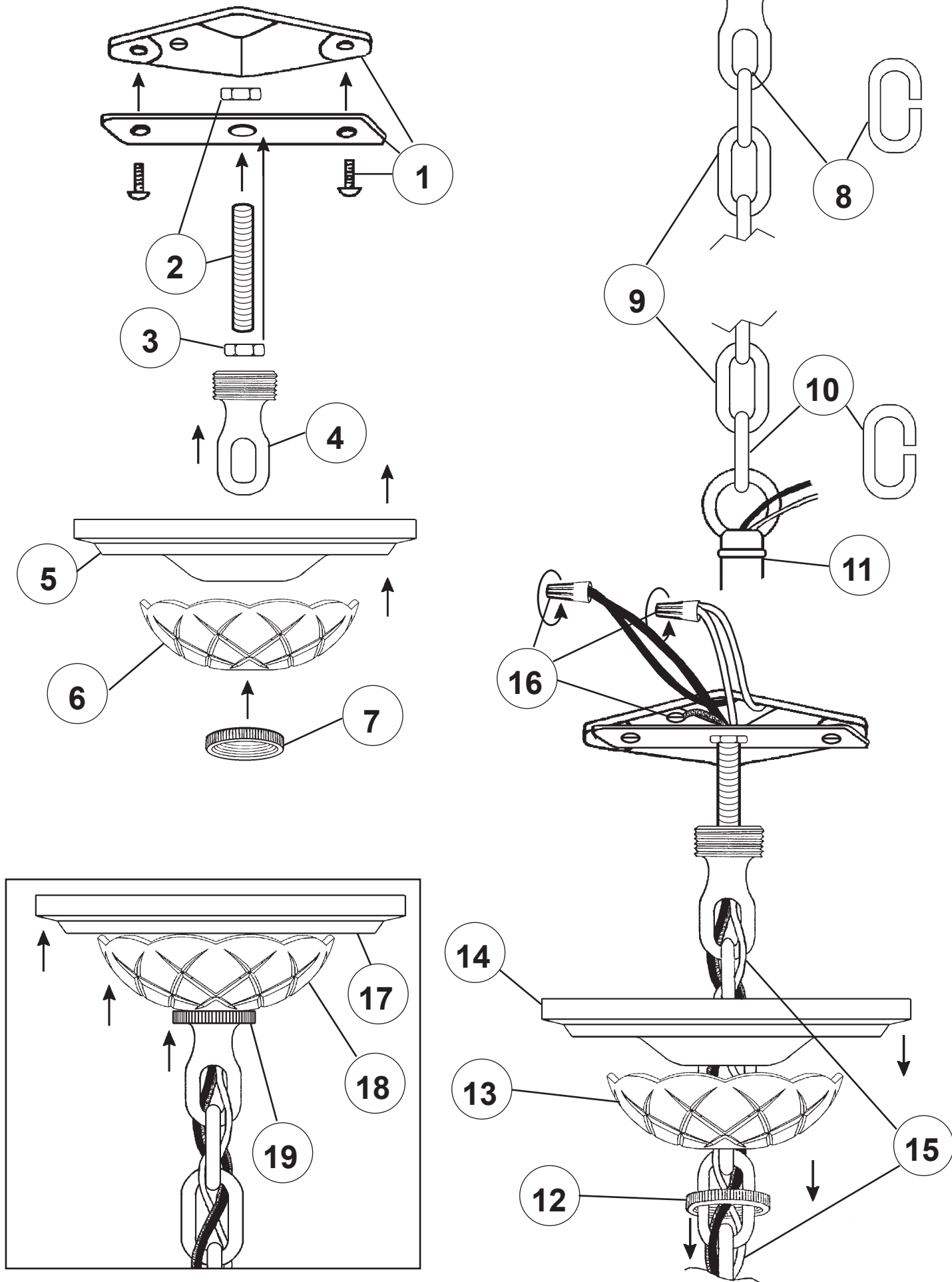



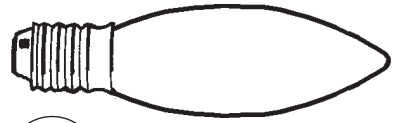

20

You will need 4 - B10
25 Watts Recommended
60 Watts Max

Install bulb and be sure
to test fixture **BEFORE**
trimming.

