

CRYSTORAMA

LIGHTING THE WAY FOR SIXTY YEARS



Crystorama.com

ASSEMBLY INSTRUCTION MODEL #WIN-616-BF-CL-MWP

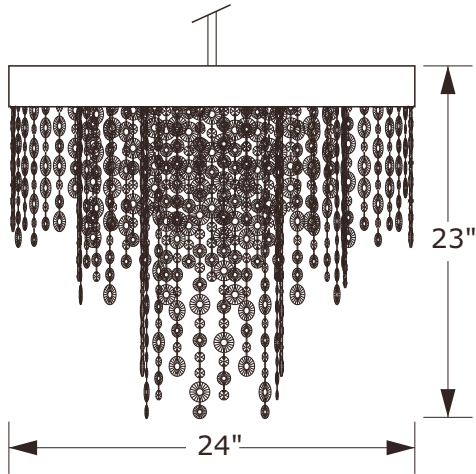

DETAILED ILLUSTRATION

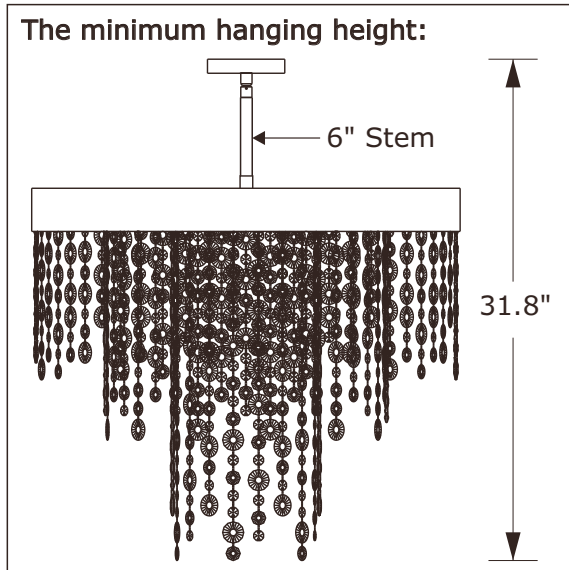

WARNING:



Electrical Danger Turn Power Off

All electrical components must be installed by a licensed electrician in accordance with the National Electric Code and the appropriate local electrical codes.



You will need 6 -Candelabra Base Bulb

40 Watts Recommended 60 Watts Max.

USE LED BULBS FOR EXTENDED USE
THIS FIXTURE IS DAMP RATED

How to Install

1. Do a complete inventory of all parts and components before you start installation.
2. Attach all four stems together, making sure the 6" stem is installed and located at the top.
3. Feed fixtures wiring through the stem assembly prior to connection.
4. Now take the bottom of the stem assembly (12" stem) and connect it to the fixture frame.
5. The top side of the stem assembly (6" stem), will then be attached to the swivel.
6. Insert recommended bulb (not included).
7. Dress the fixture with crystal as illustrated.

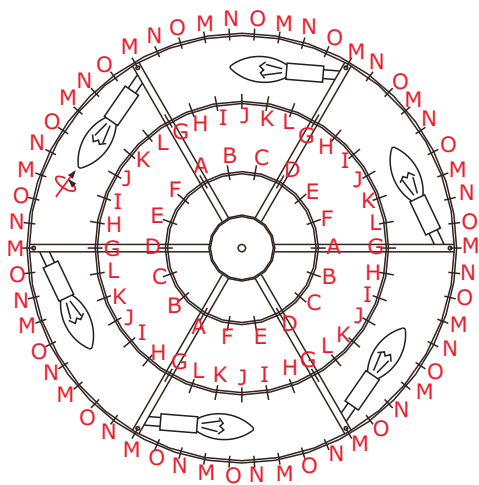

SUGGESTED CRYSTAL PLACEMENT TOP VIEW
PLEASE REFERENCE CRYSTAL KEY

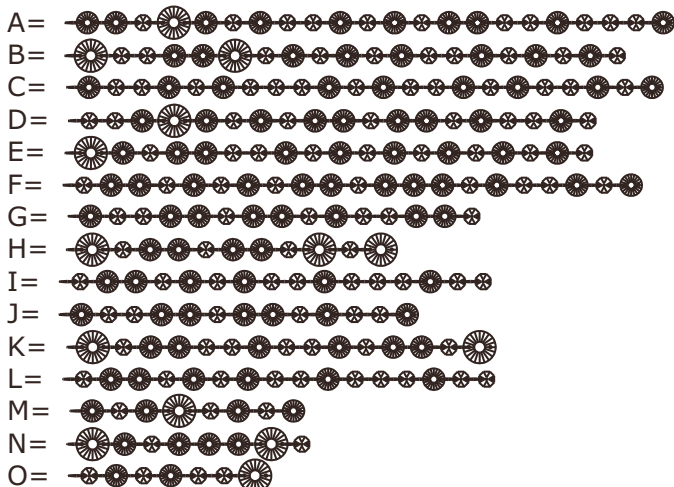

Crystal Key

- | | |
|--|---|
| A.3 Sets.
(11)14mm + (10)20mm + (1)30mm | H.6 Sets.
(4)14mm + (4)20mm + (3)30mm |
| B.3 Sets.
(10)14mm + (8)20mm + (2)30mm | I.6 Sets.
(10)14mm + (6)20mm |
| C.3 Sets.
(13)14mm + (9)20mm | J.6 Sets.
(6)14mm + (7)20mm |
| D.3 Sets.
(9)14mm + (9)20mm + (1)30mm | K.6 Sets.
(7)14mm + (6)20mm + (2)30mm |
| E.3 Sets.
(9)14mm + (9)20mm + (1)30mm | L.6 Sets.
(10)14mm + (6)20mm |
| F.3 Sets.
(9)14mm + (12)20mm | M.18 Sets.
(3)14mm + (4)20mm + (1)30mm |
| G.6 Sets.
(7)14mm + (8)20mm | N.18 Sets.
(2)14mm + (4)20mm + (2)30mm |
| | O.18 Sets.
(4)14mm + (2)20mm + (1)30mm |

WARNING: This product can expose you to Lead, which is known to the State of California to cause cancer and/or birth defects or reproductive harm. For more information go to www.P65Warnings.ca.gov.



PART NUMBER MODEL #WIN-616-BF-CL-MWP

Part Number

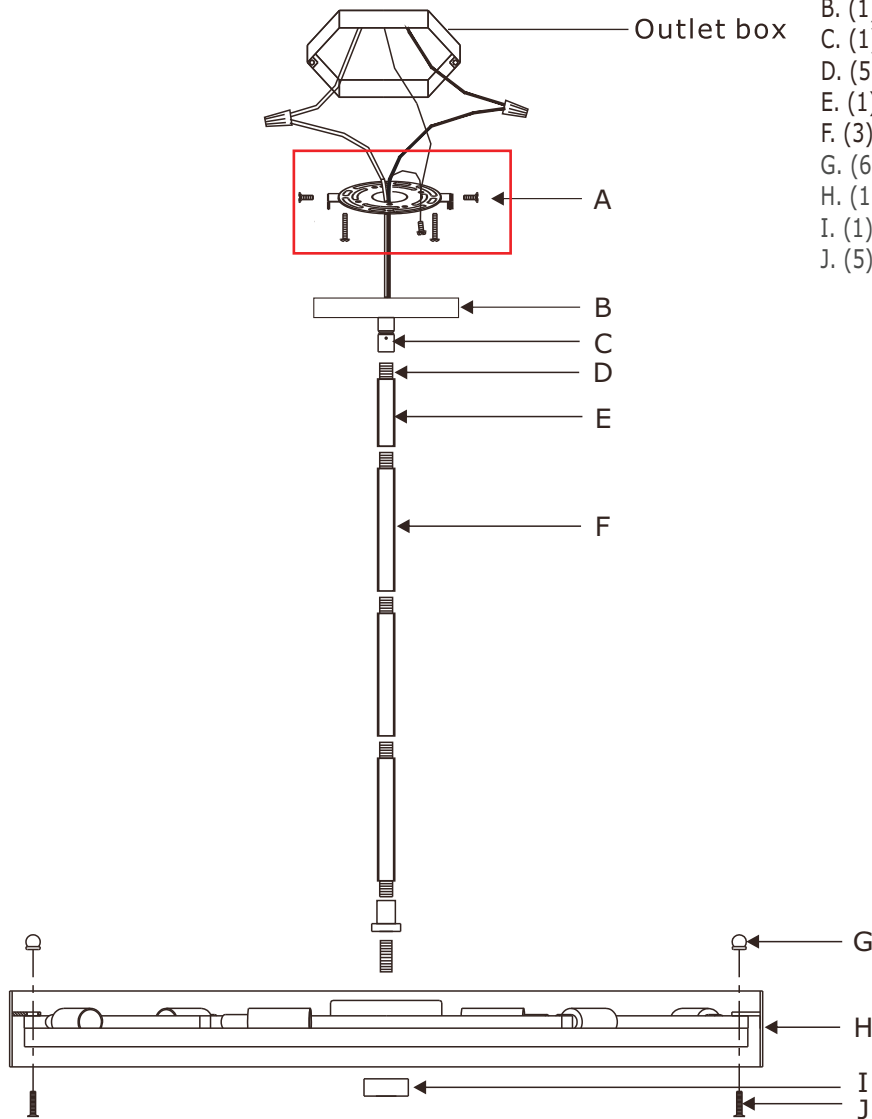

- A. (1) - Mounting Hardware
- B. (1) - Canopy(W5",H0.79") #XRE616BFCAN5IN
- C. (1) - Swivel
- D. (5) - Threaded Pipe
- E. (1) - Hanging Stem(6",15.9mm) #XRE615BFROD6IN
- F. (3) - Hanging Stem(12",15.9mm) #XRE615BFROD12IN
- G. (6) - Ball Nut # XRE612BFBANUT
- H. (1) - Metal Frame
- I. (1) - Finial # XRE615BFFIN
- J. (5) - Flat Screw