

# RENAISSANCE 3780- \_\_\_\_\_

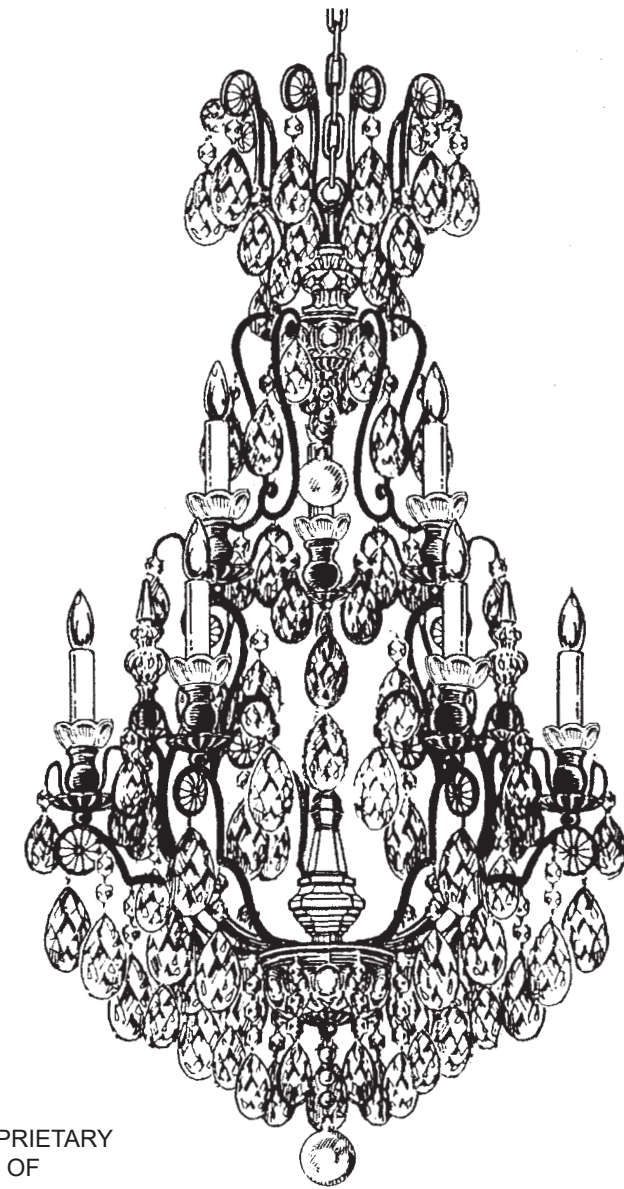











9 + 1 Lights  
Diameter: 21"  
Body Length: 40"  
Hanging Weight: 38 lbs.

**T**HIS DESIGN IS THE PROPRIETARY  
TRADE DRESS/TRADEMARK OF  
W SCHONBEK LLC.

 **SCHONBEK** | 1870

 **SCHONBEK** | 1870

								
MAX 60 W	MAX 15 W	110-120 V						

All electrical components must be installed by a licensed electrician in accordance with the National Electric Code and the appropriate local electrical codes.

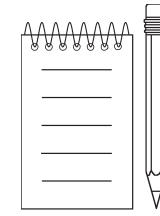
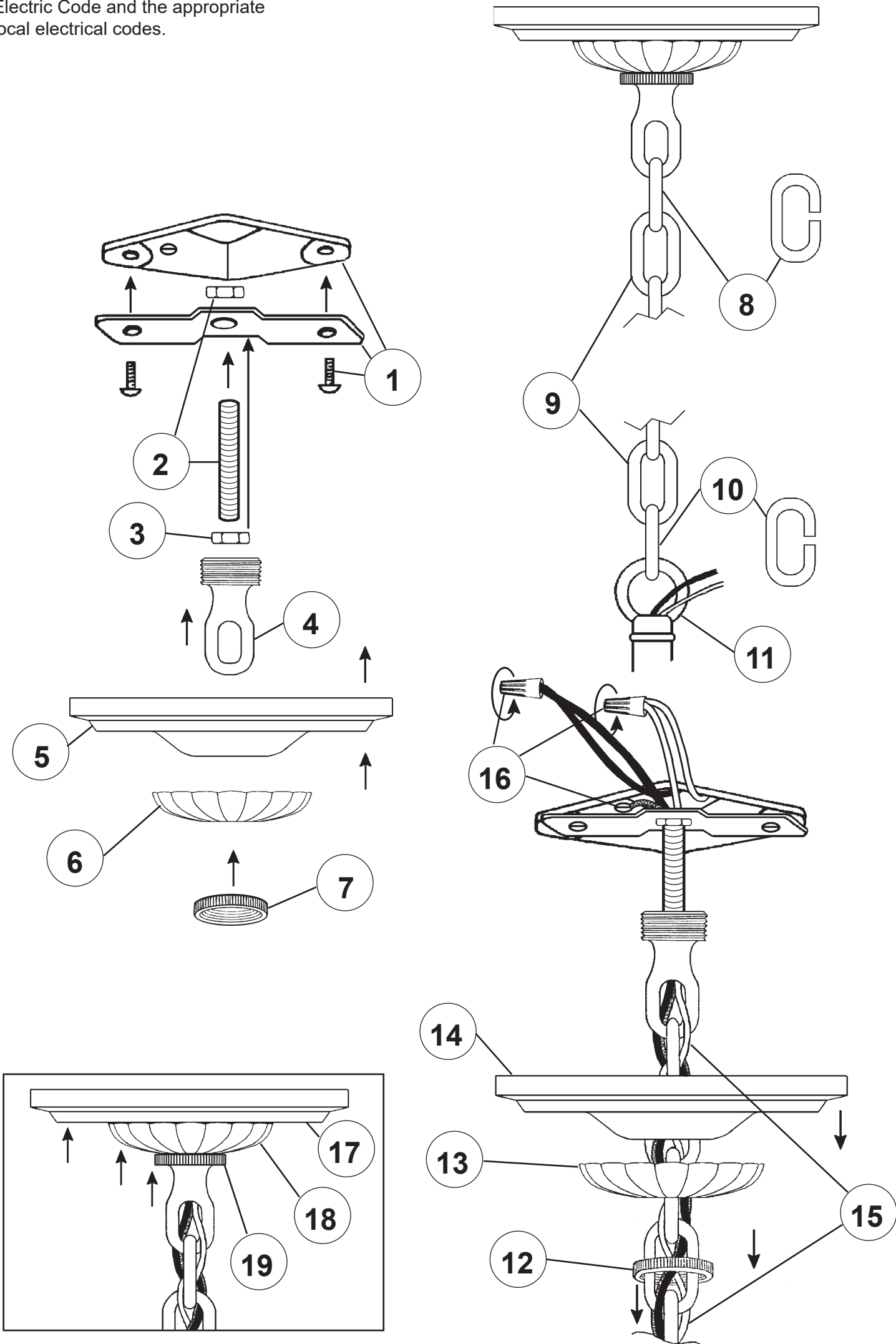

**Crystal Set 3 in Black**

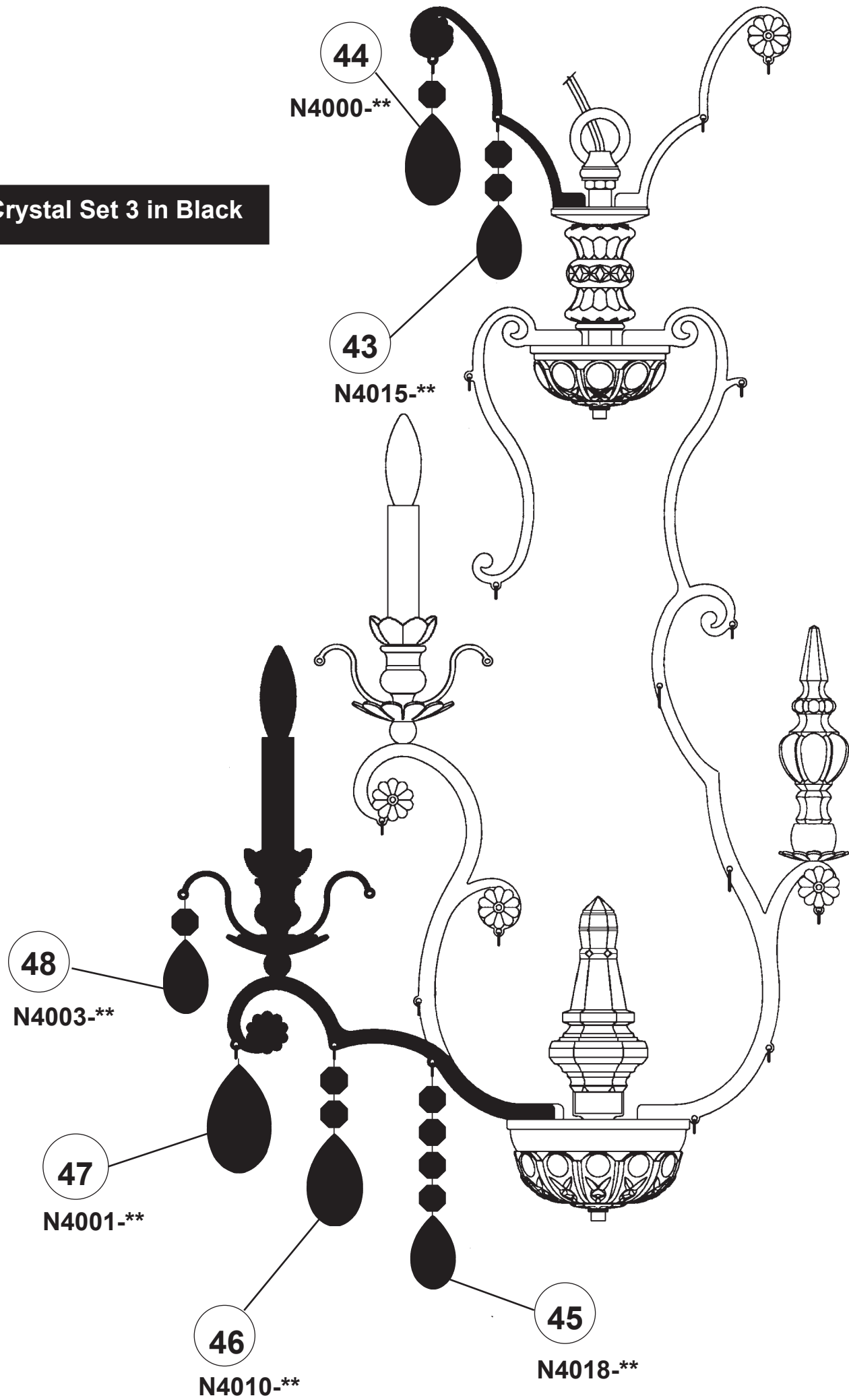

**SET 1**

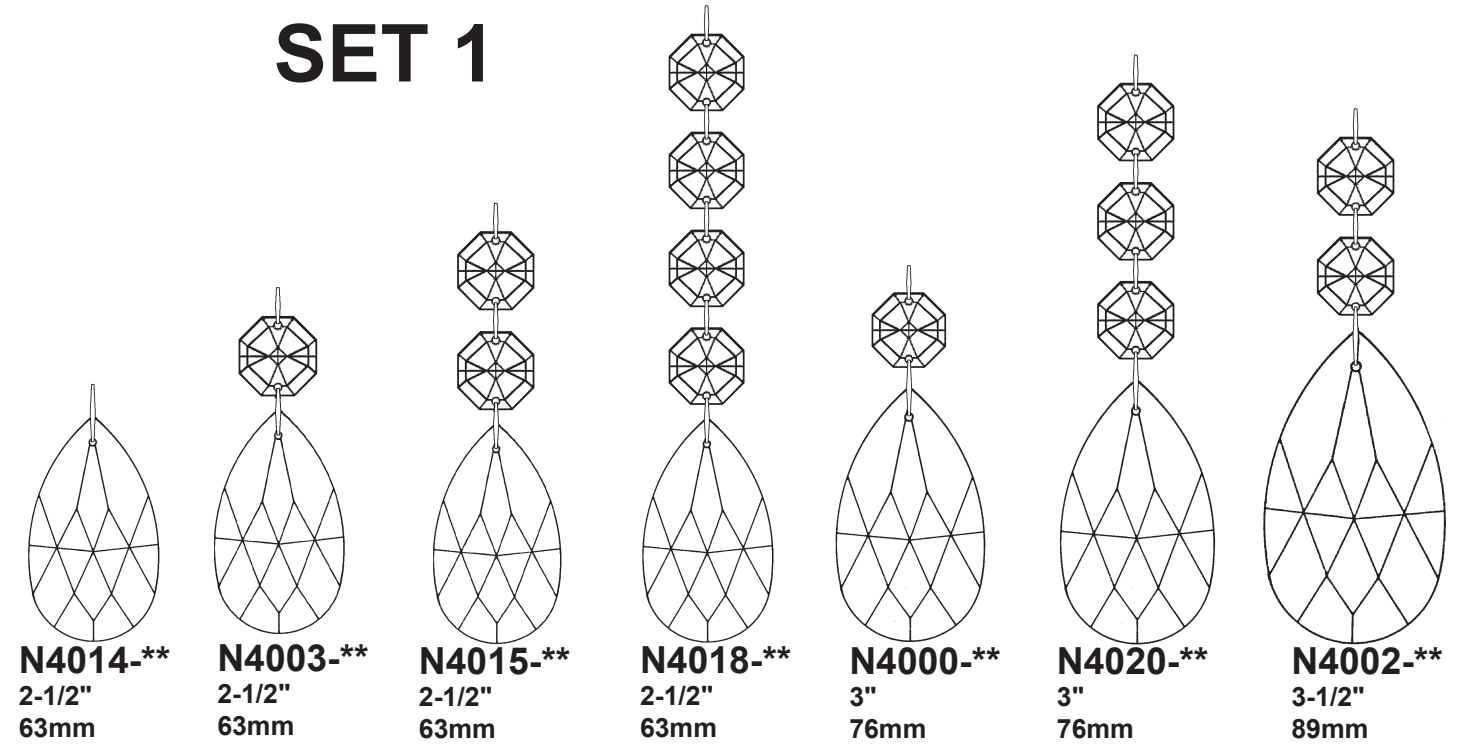

**SET 2**

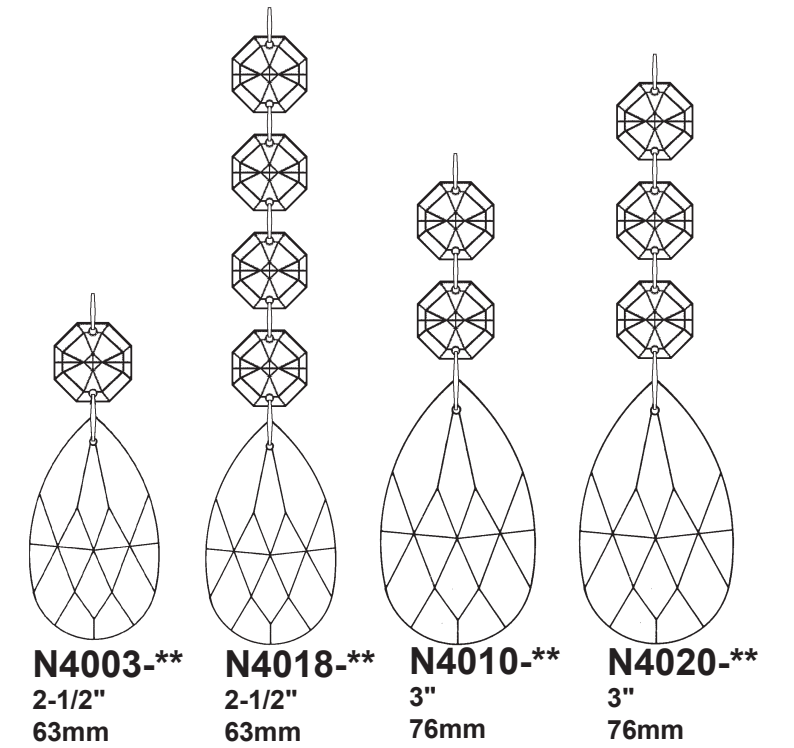

**SET 3**

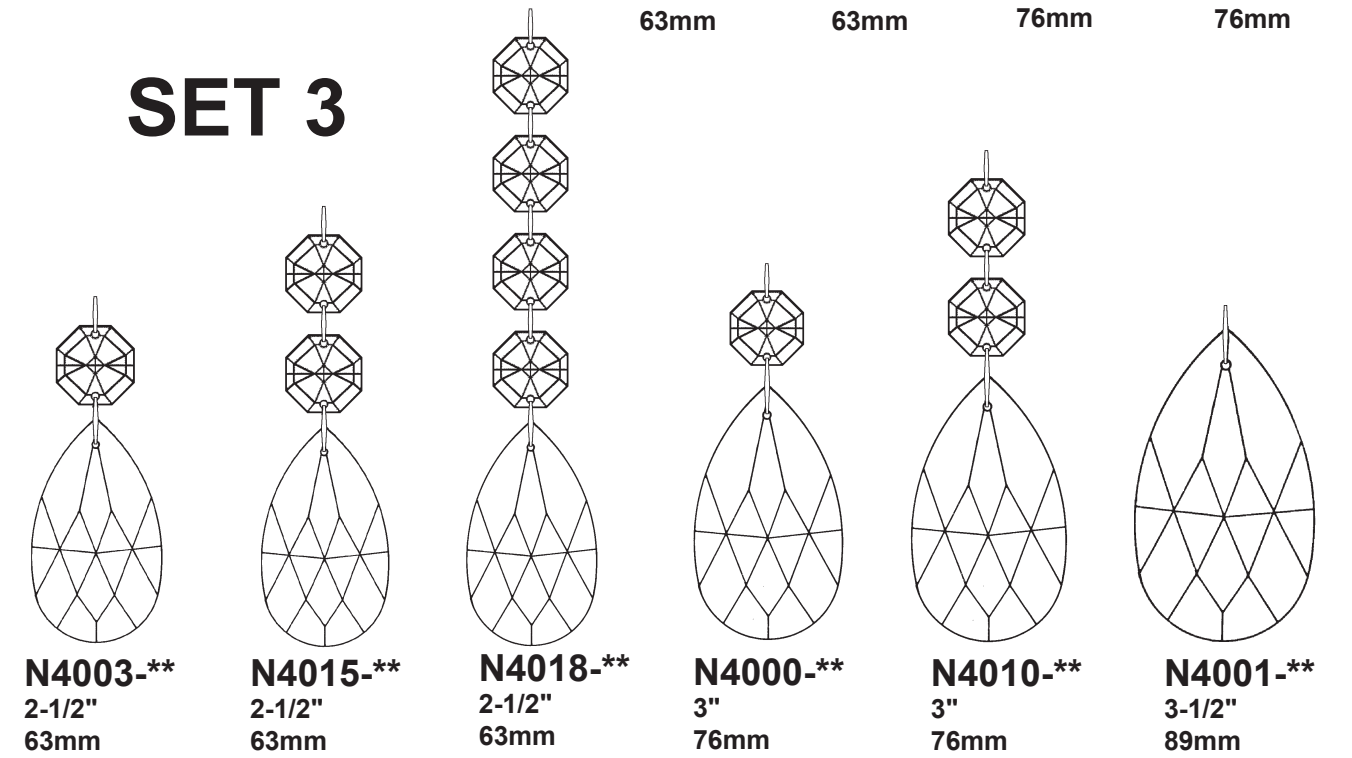

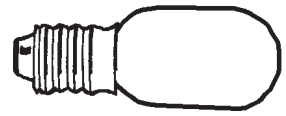

You will need 1 - T7  
15 Watts Max  
(Center Light)

21



You will need 9 - B10  
25 Watts Recommended  
60 Watts Max

Install bulbs and be sure  
to test fixture BEFORE  
trimming.

**Crystal Set 2 in Black**

**Crystal Set 1 in Black**

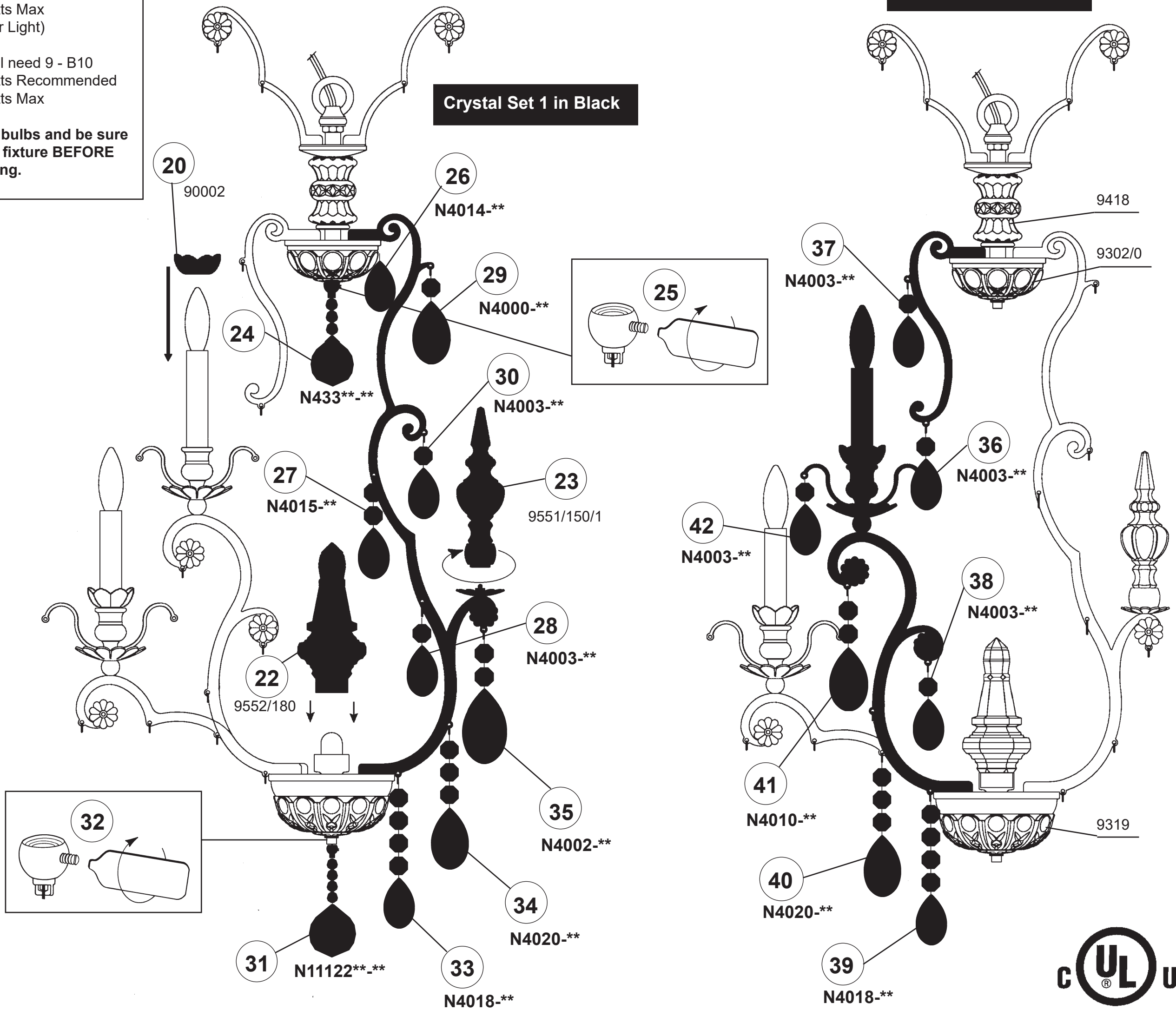

# RENAISSANCE 3780- \_\_\_\_

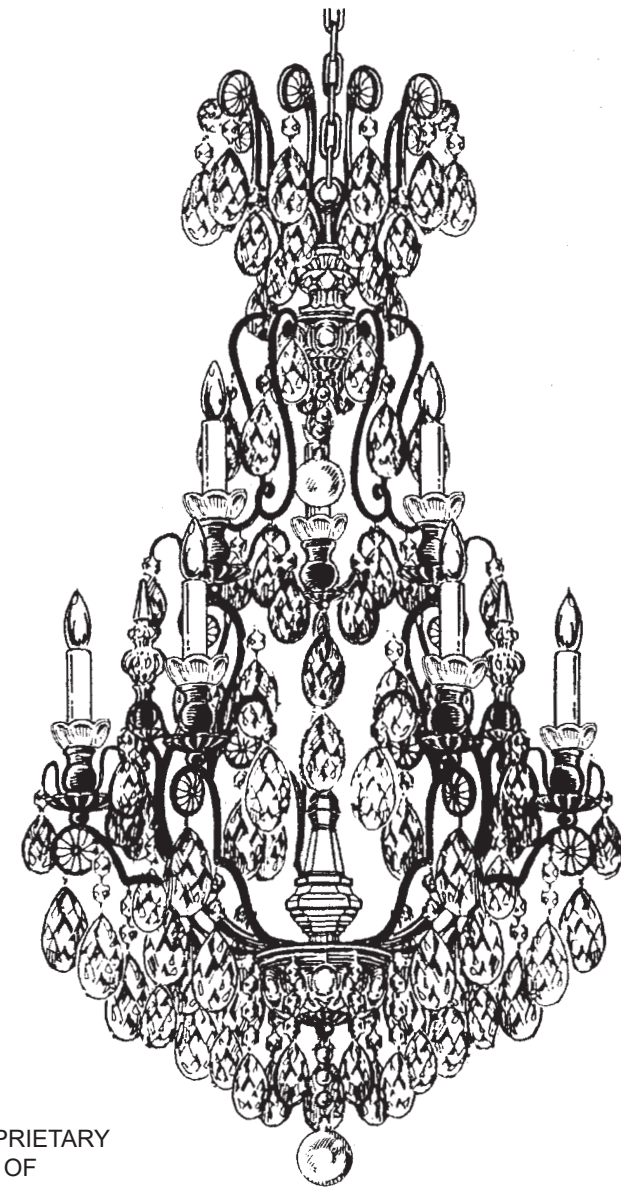











9 + 1 Lights  
Diameter: 21"  
Body Length: 40"  
Hanging Weight: 38 lbs.

**T**HIS DESIGN IS THE PROPRIETARY  
TRADE DRESS/TRADEMARK OF  
W SCHONBEK LLC.

 **SCHONBEK** | 1870

 **SCHONBEK** | 1870

								
MAX <b>60</b> W	MAX <b>15</b> W	110-120 V						

All electrical components must be installed by a licensed electrician in accordance with the National Electric Code and the appropriate local electrical codes.

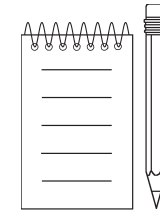
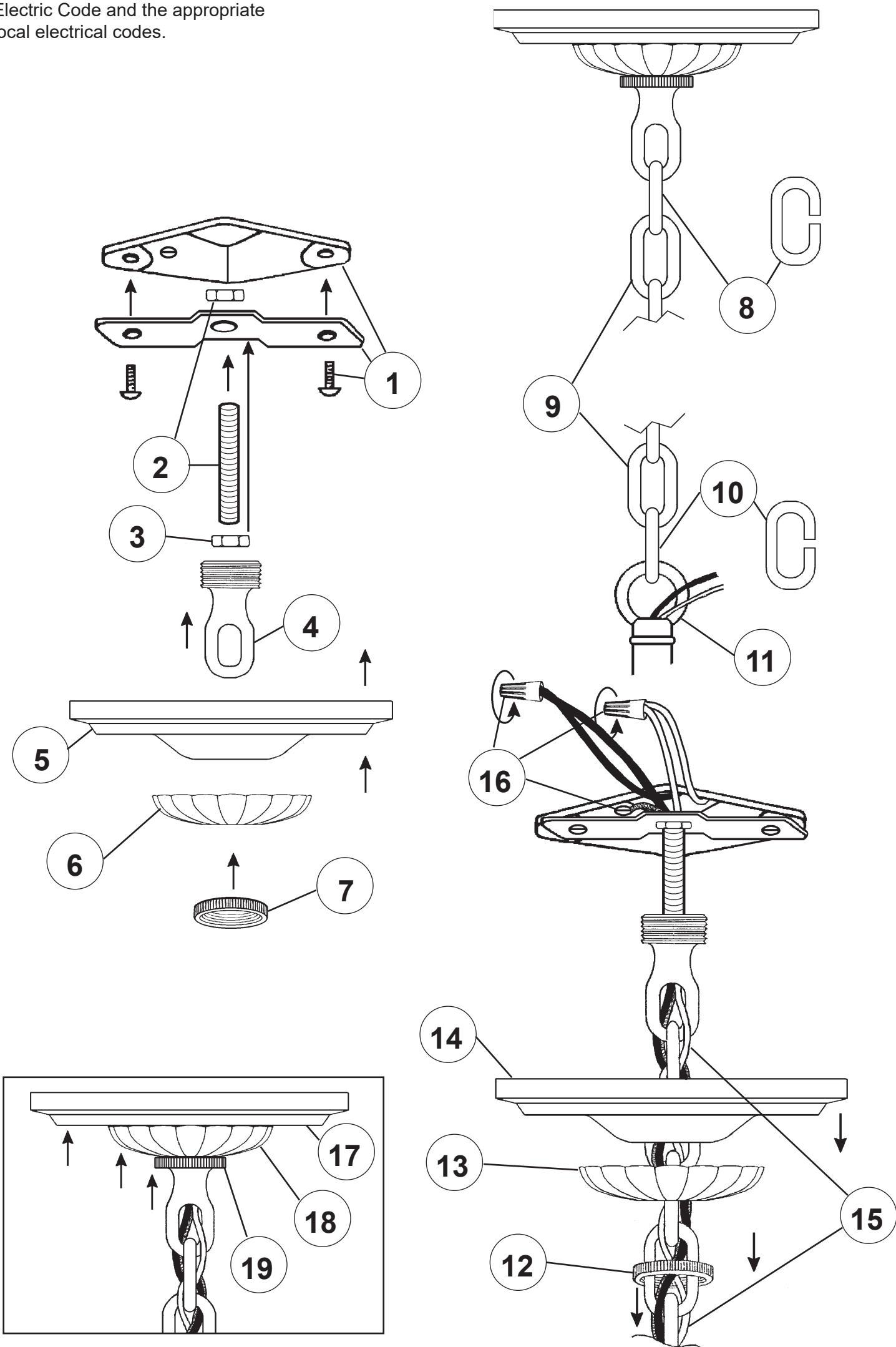

**Crystal Set 3 in Black**

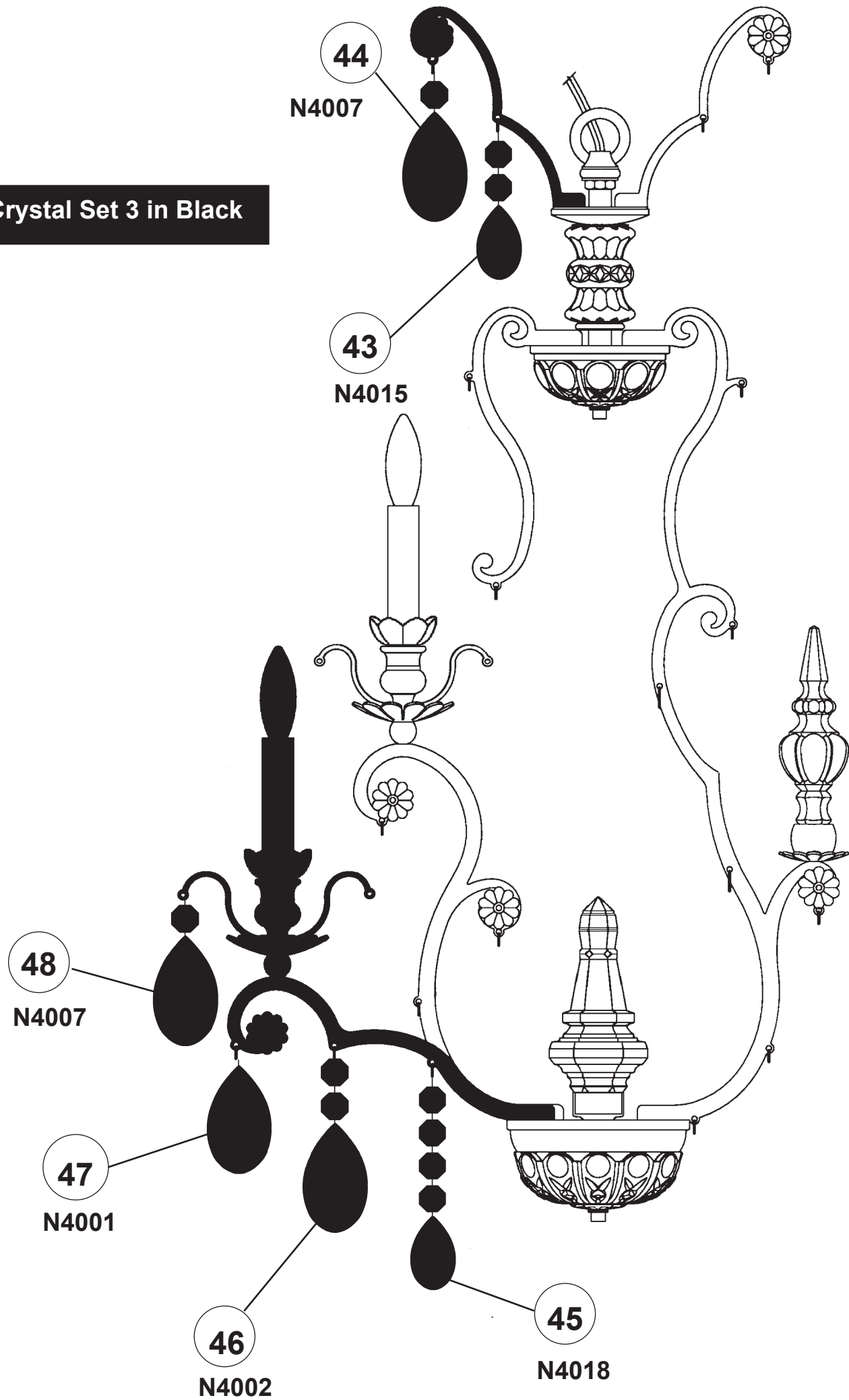

44  
N4007

43  
N4015

48  
N4007

47  
N4001

46  
N4002

45  
N4018

**SET 1**

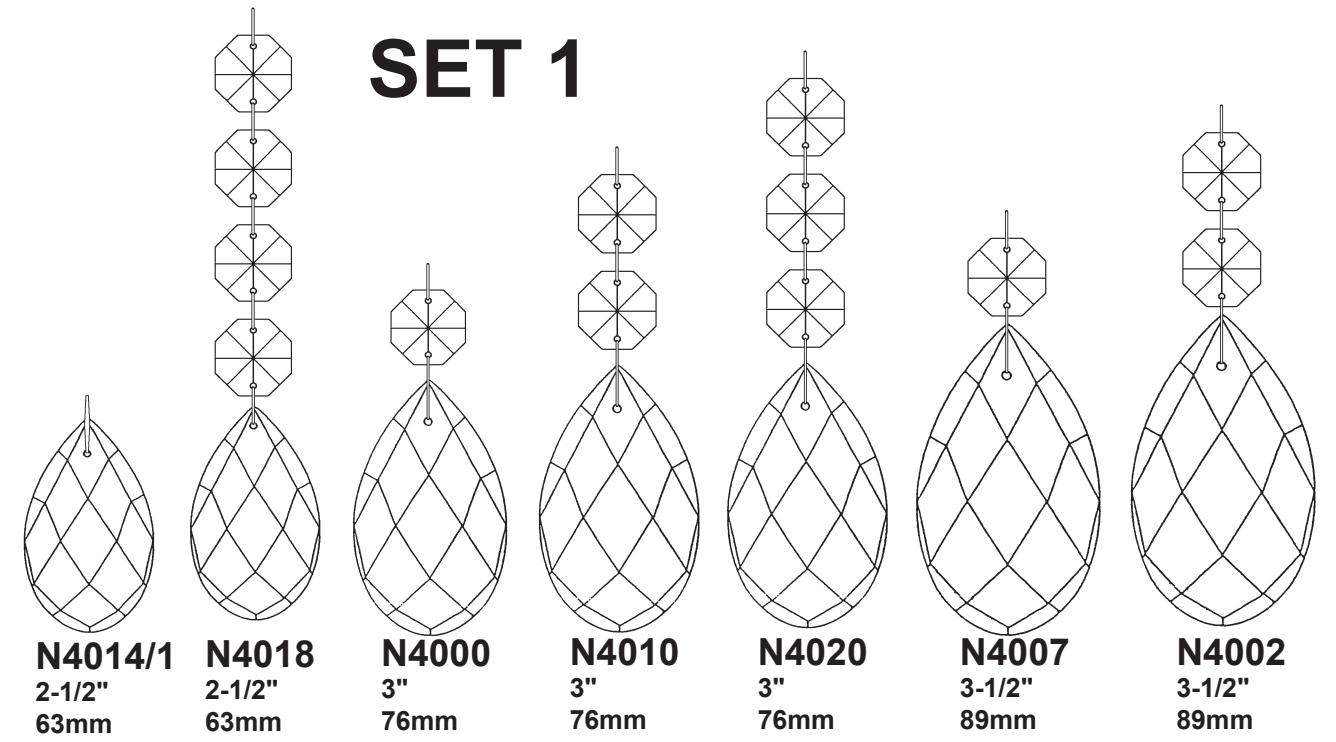

<b>N4014/1</b> 2-1/2" 63mm	<b>N4018</b> 2-1/2" 63mm	<b>N4000</b> 3" 76mm	<b>N4010</b> 3" 76mm	<b>N4020</b> 3" 76mm	<b>N4007</b> 3-1/2" 89mm	<b>N4002</b> 3-1/2" 89mm
----------------------------------	--------------------------------	----------------------------	----------------------------	----------------------------	--------------------------------	--------------------------------

**SET 2**

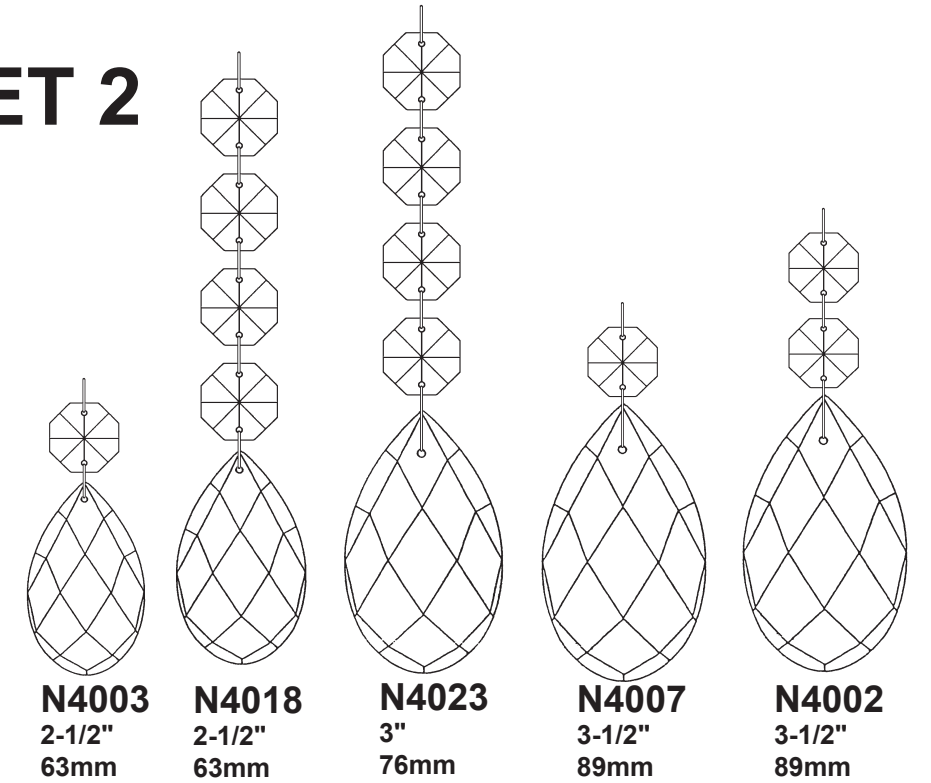

<b>N4003</b> 2-1/2" 63mm	<b>N4018</b> 2-1/2" 63mm	<b>N4023</b> 3" 76mm	<b>N4007</b> 3-1/2" 89mm	<b>N4002</b> 3-1/2" 89mm
--------------------------------	--------------------------------	----------------------------	--------------------------------	--------------------------------

**SET 3**

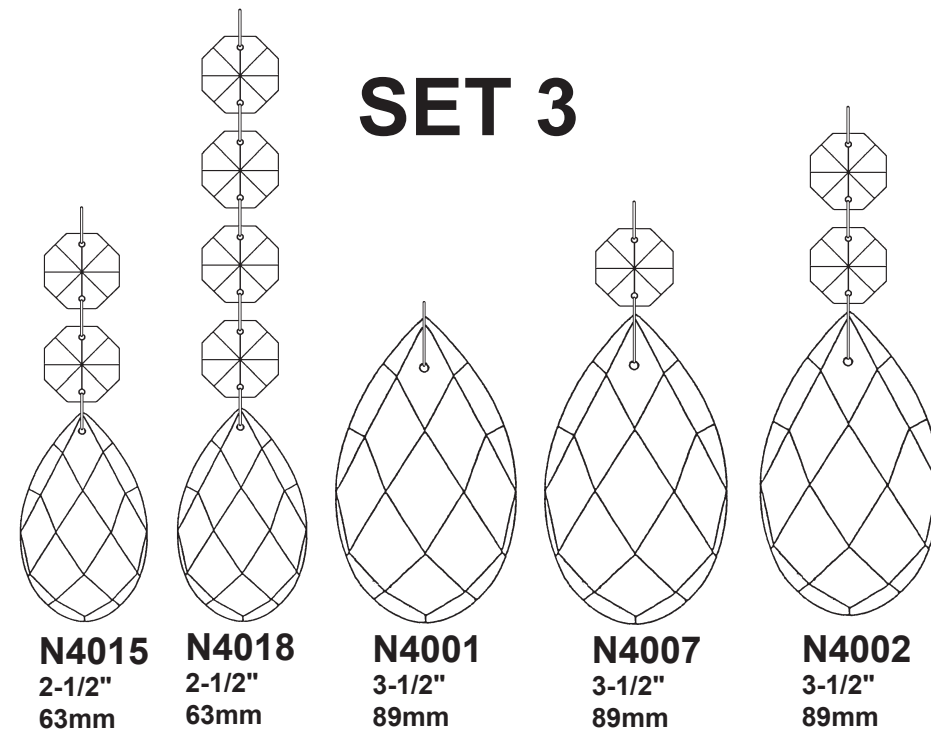

<b>N4015</b> 2-1/2" 63mm	<b>N4018</b> 2-1/2" 63mm	<b>N4001</b> 3-1/2" 89mm	<b>N4007</b> 3-1/2" 89mm	<b>N4002</b> 3-1/2" 89mm
--------------------------------	--------------------------------	--------------------------------	--------------------------------	--------------------------------

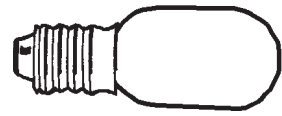

You will need 1 - T7  
15 Watts Max  
(Center Light)

21



You will need 9 - B10  
25 Watts Recommended  
60 Watts Max

Install bulbs and be sure  
to test fixture BEFORE  
trimming.

**Crystal Set 2 in Black**

**Crystal Set 1 in Black**

