

CONCETTA
S24529- __ __ R

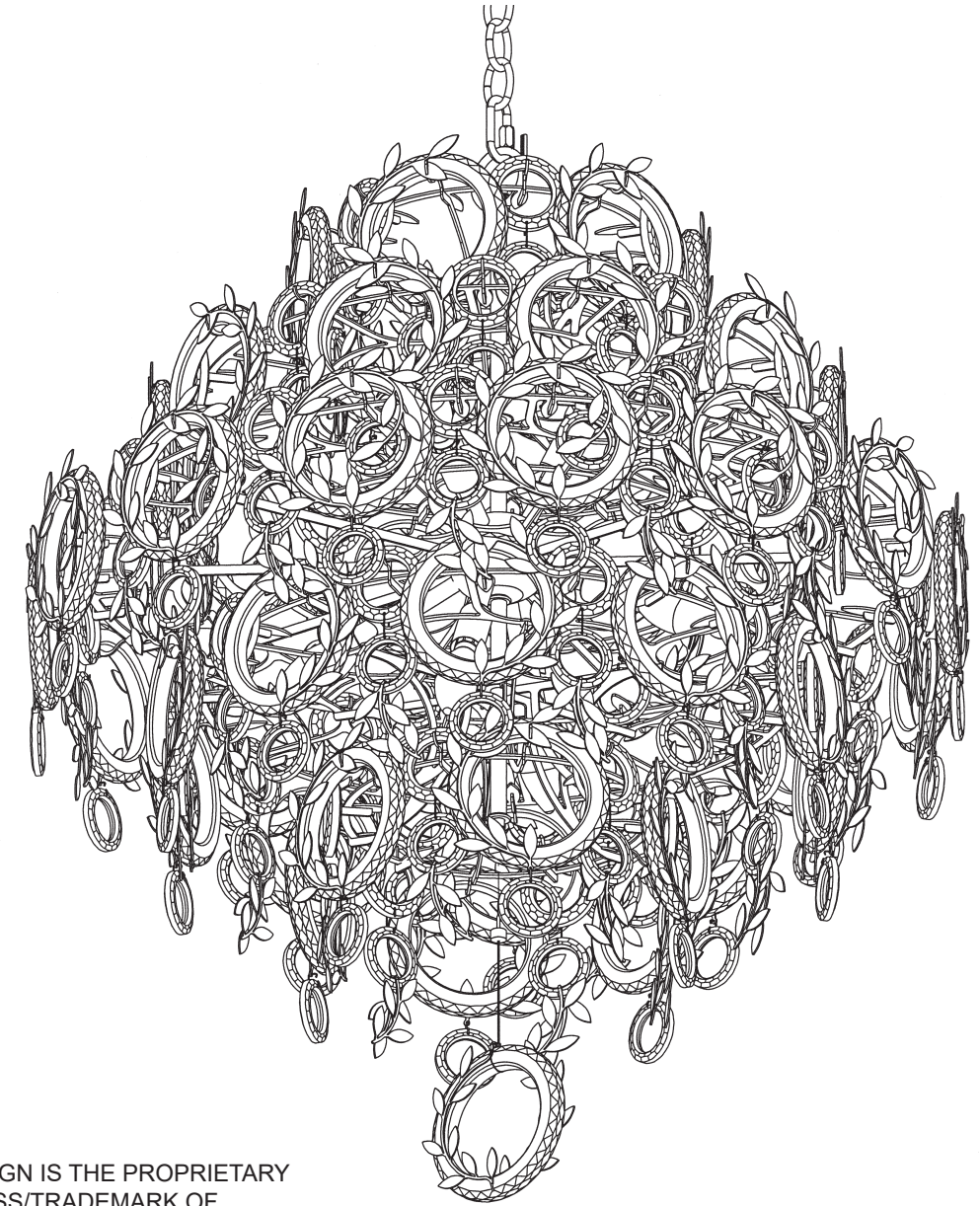

THIS DESIGN IS THE PROPRIETARY
TRADE DRESS/TRADemark OF
W SCHONBEK LLC.

SCHONBEK
*Signature*TM

SCHONBEK
*Signature*TM

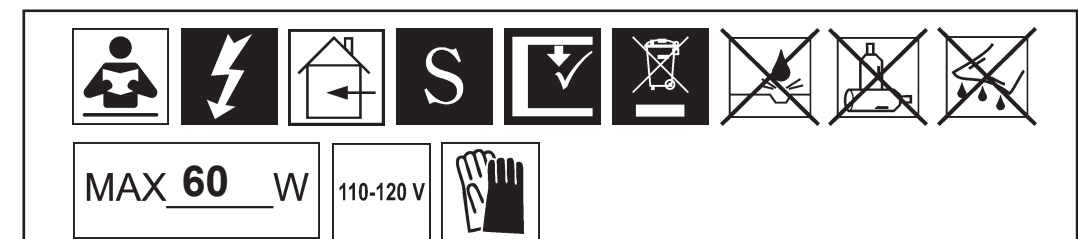

WARNING:

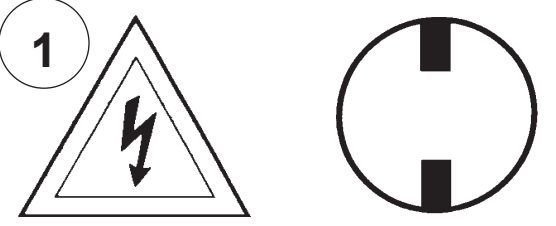
1 

Electrical Danger Turn Power Off

All electrical components must be installed by a licensed electrician in accordance with the National Electric Code and the appropriate local electrical codes.

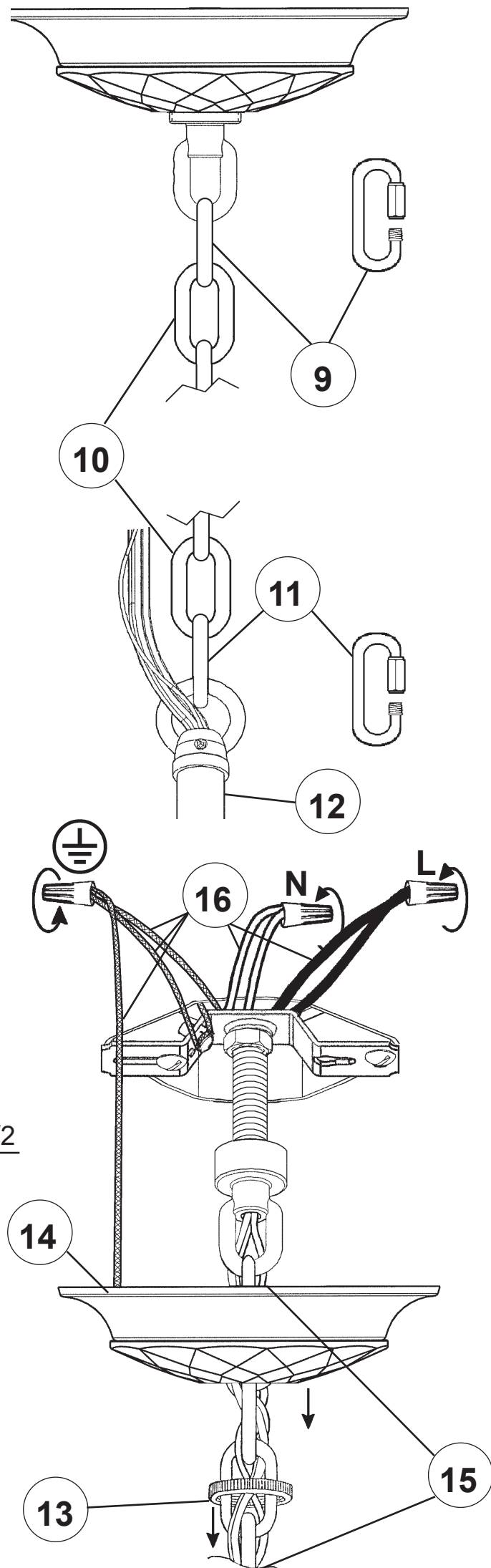
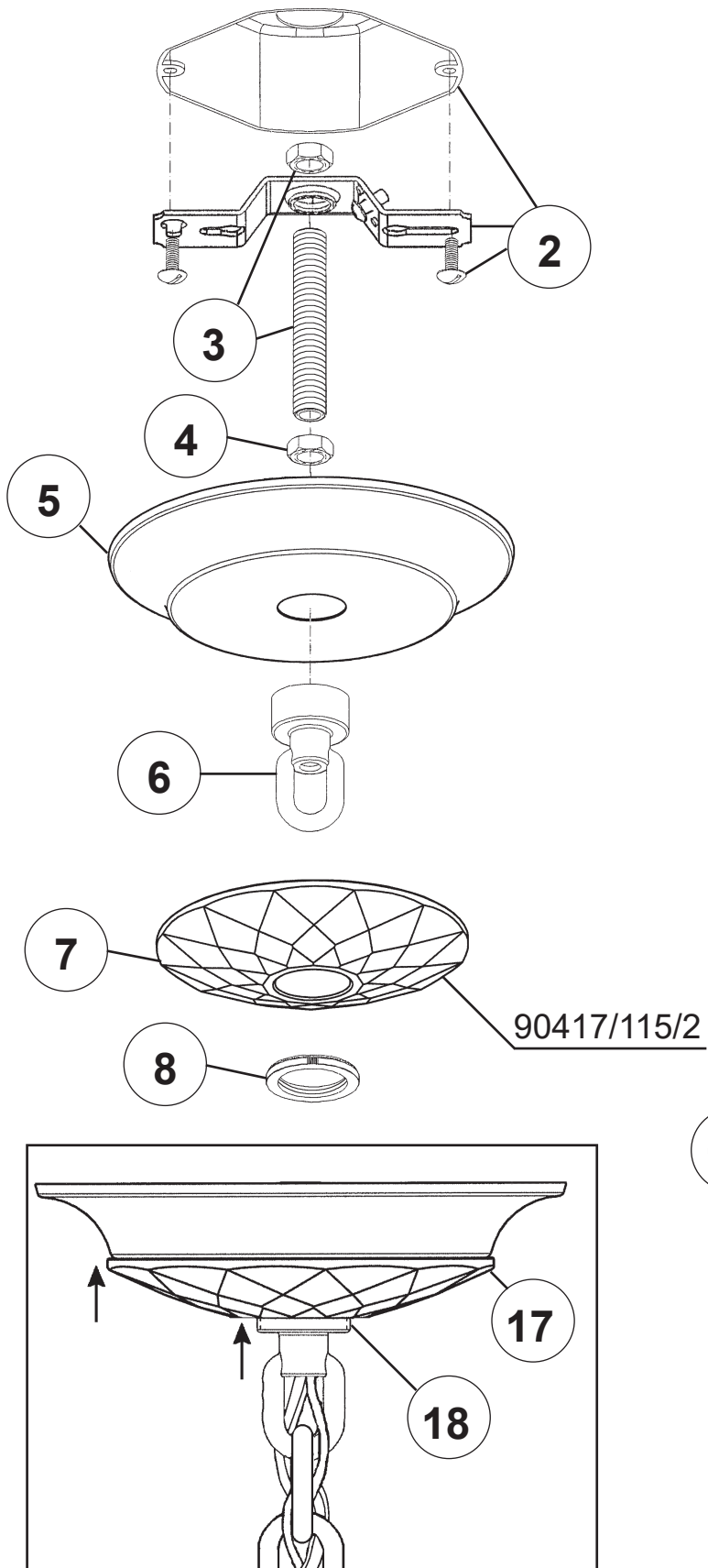

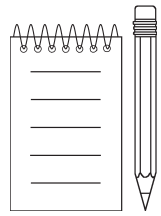

19

You will need 6 - B10
25 Watts Recommended
60 Watts Max

**Install bulbs and be sure
to test fixture BEFORE
trimming.**

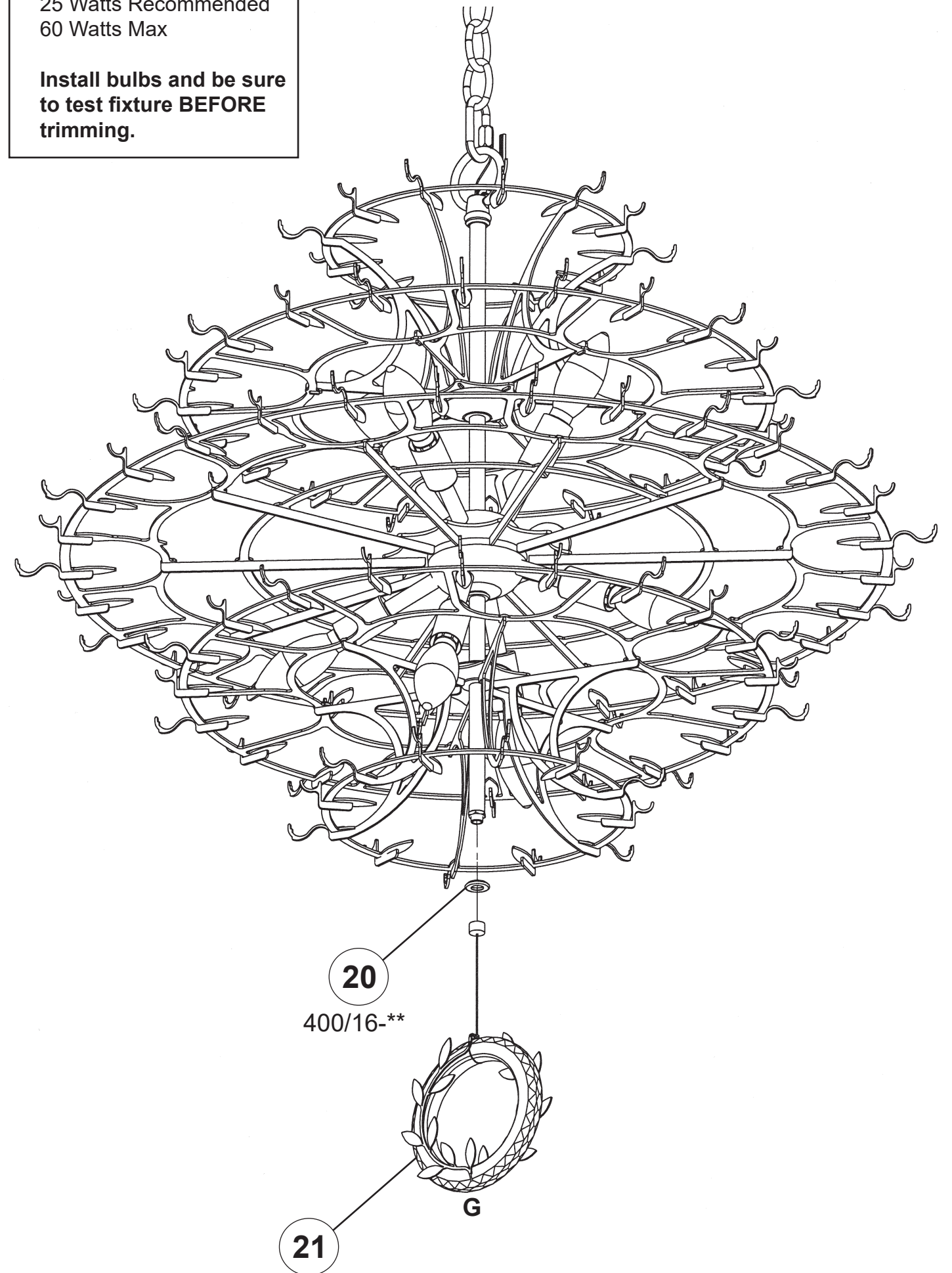
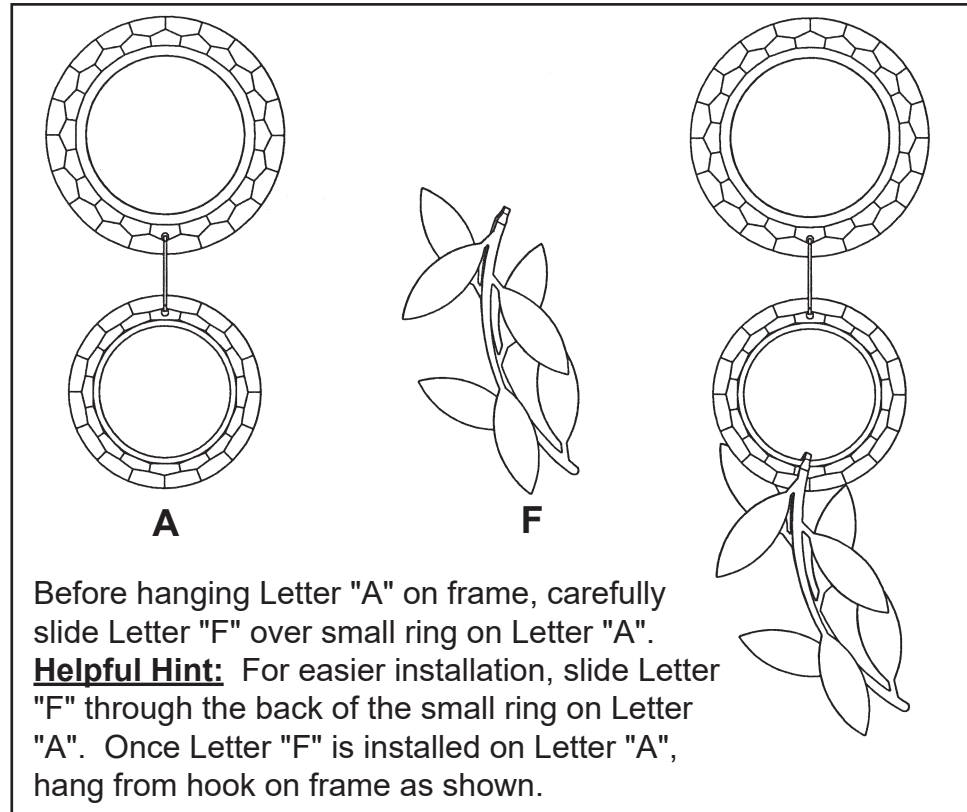
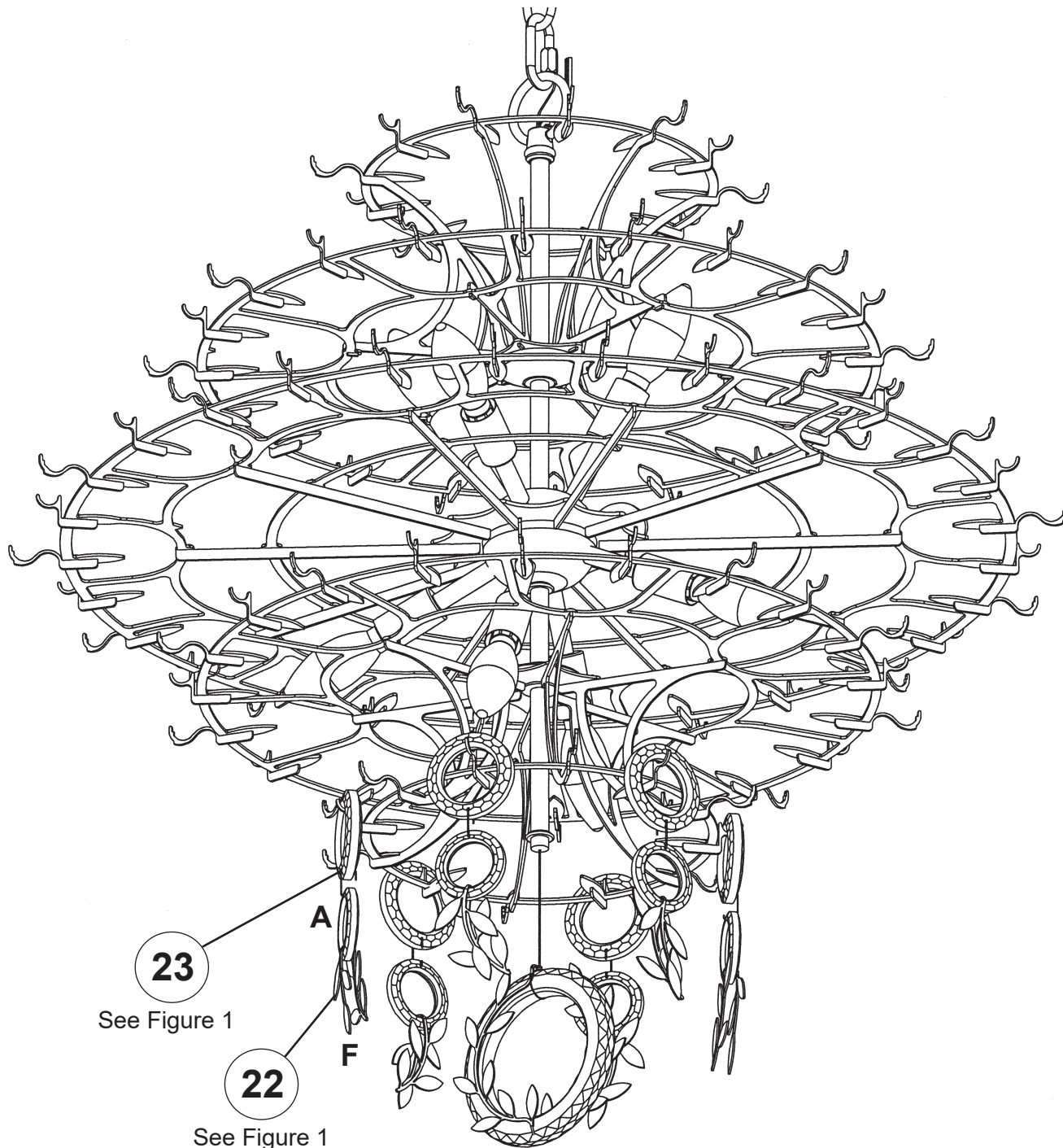

FIGURE 1



Before hanging Letter "A" on frame, carefully slide Letter "F" over small ring on Letter "A".
Helpful Hint: For easier installation, slide Letter "F" through the back of the small ring on Letter "A". Once Letter "F" is installed on Letter "A", hang from hook on frame as shown.



NOTE: REFERENCE FIGURE 2 ON PAGE 5 FOR DETAILED INSTALLATION OF LETTERS "B" AND "E".

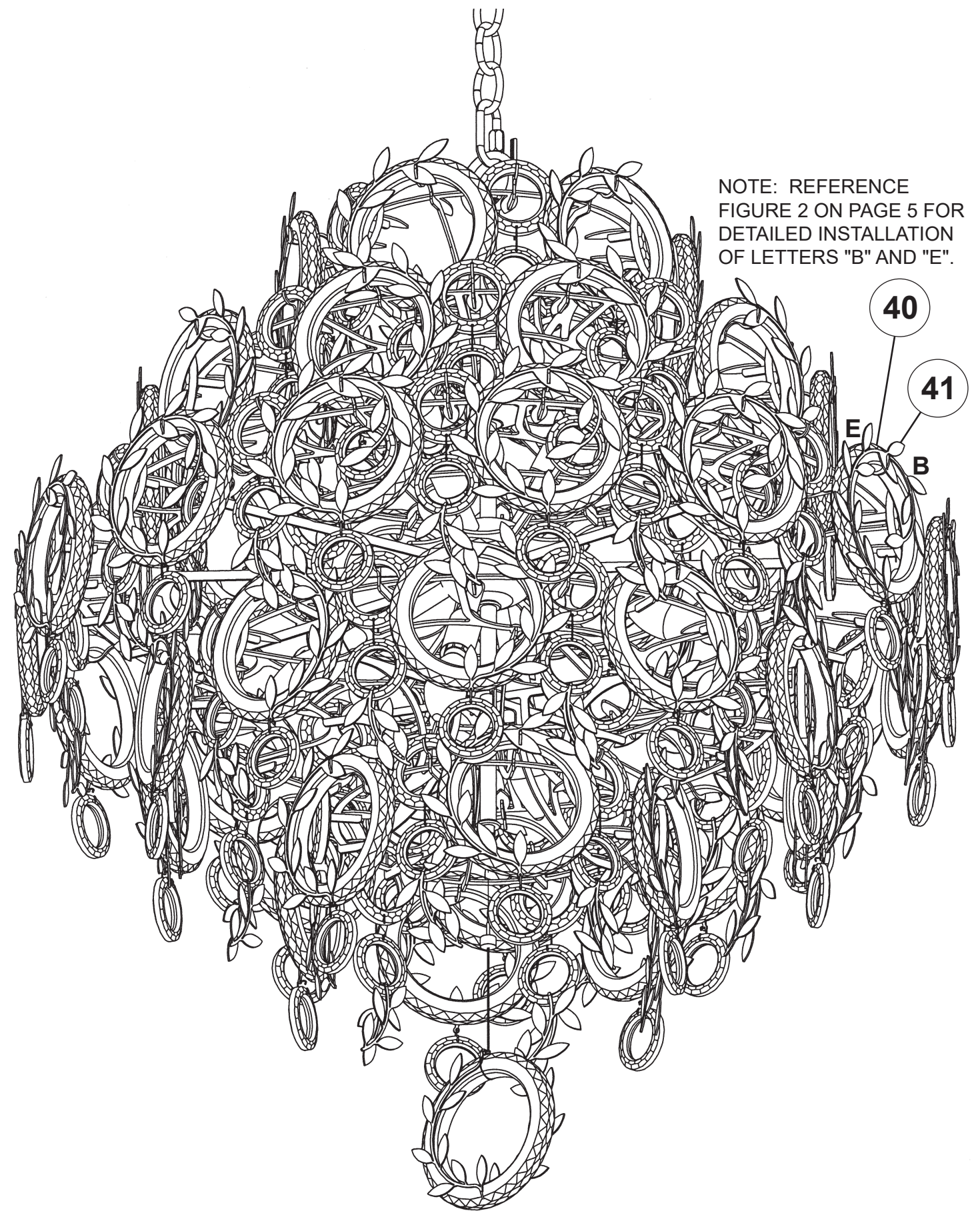

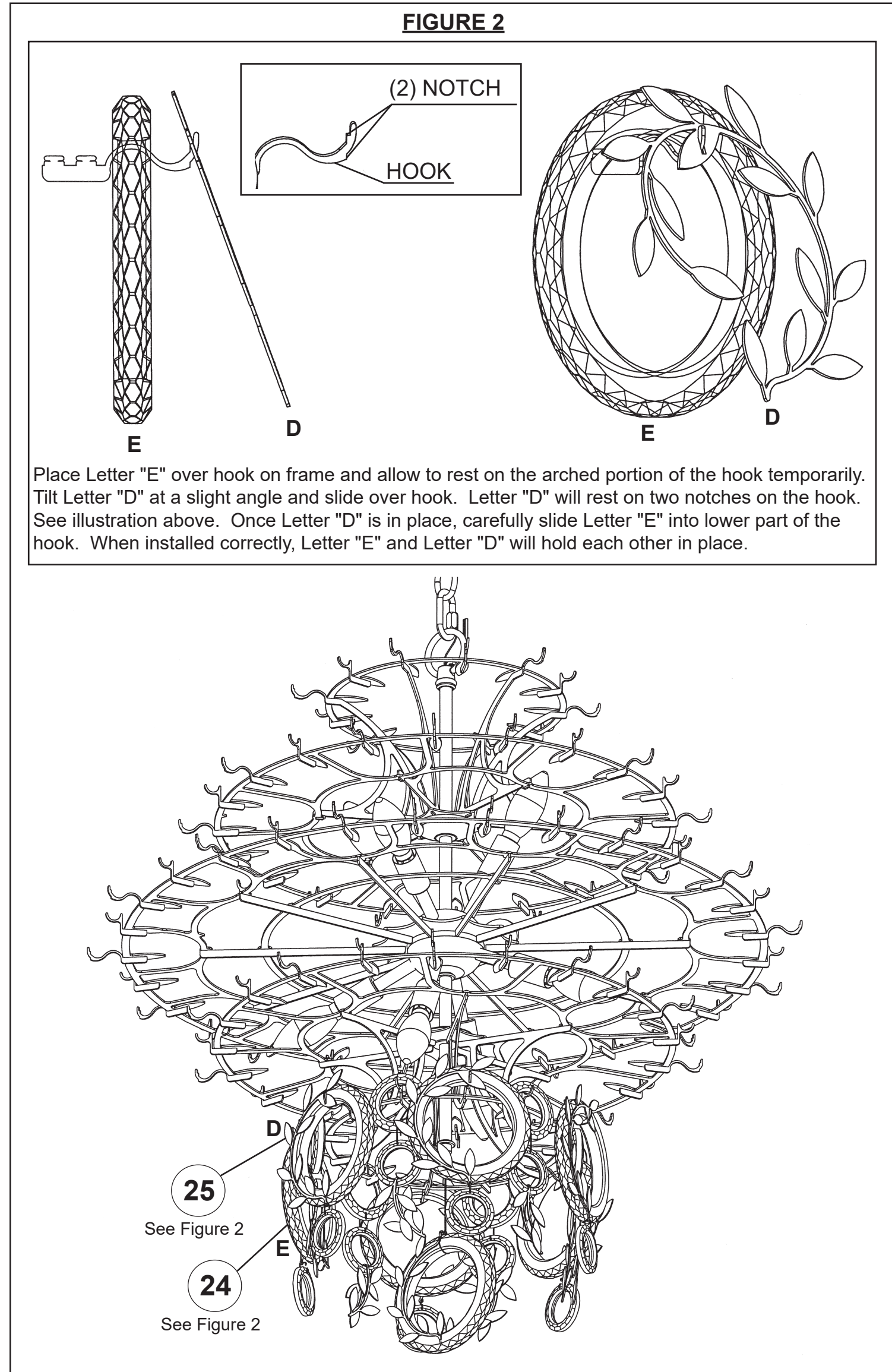
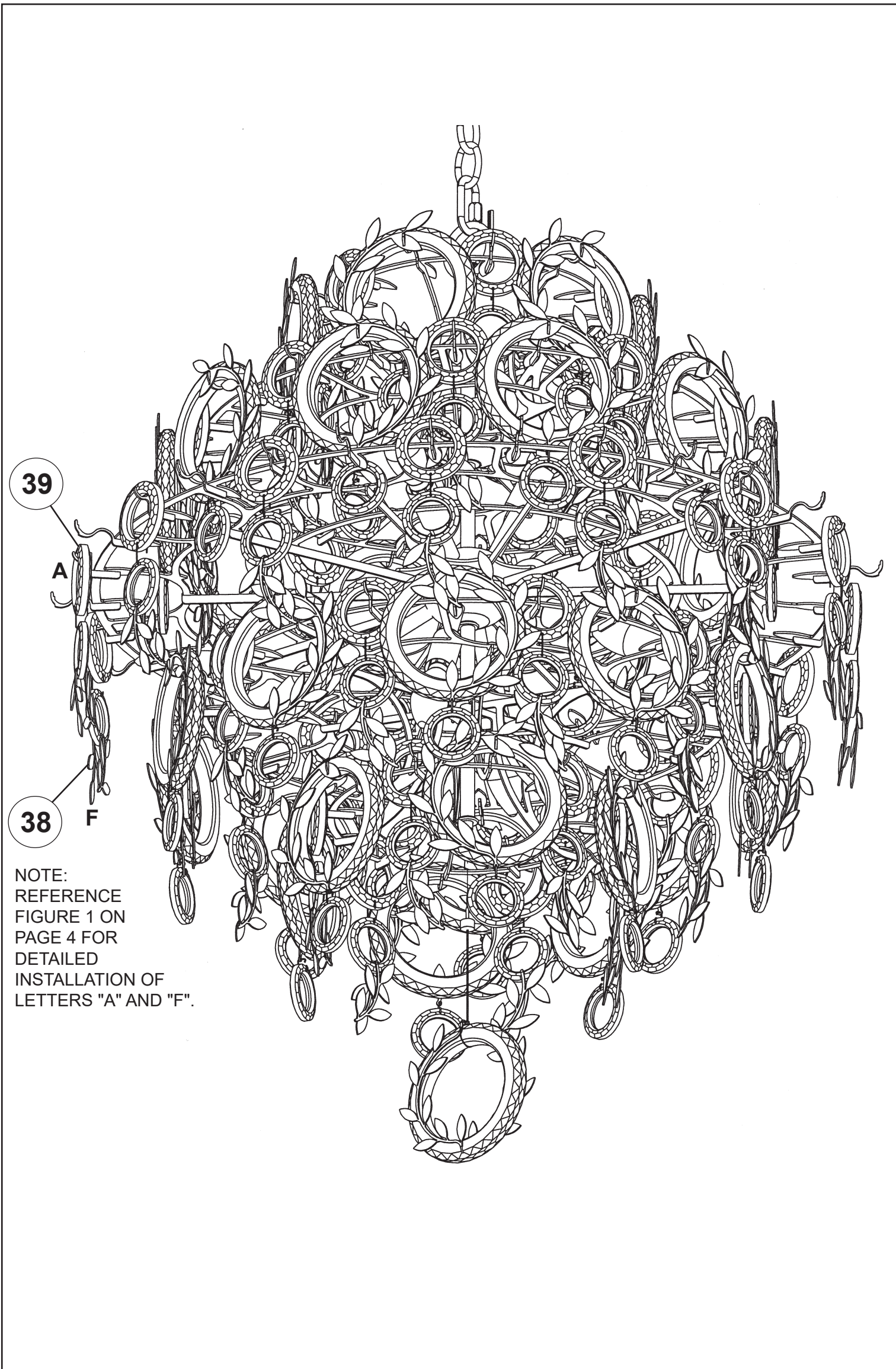

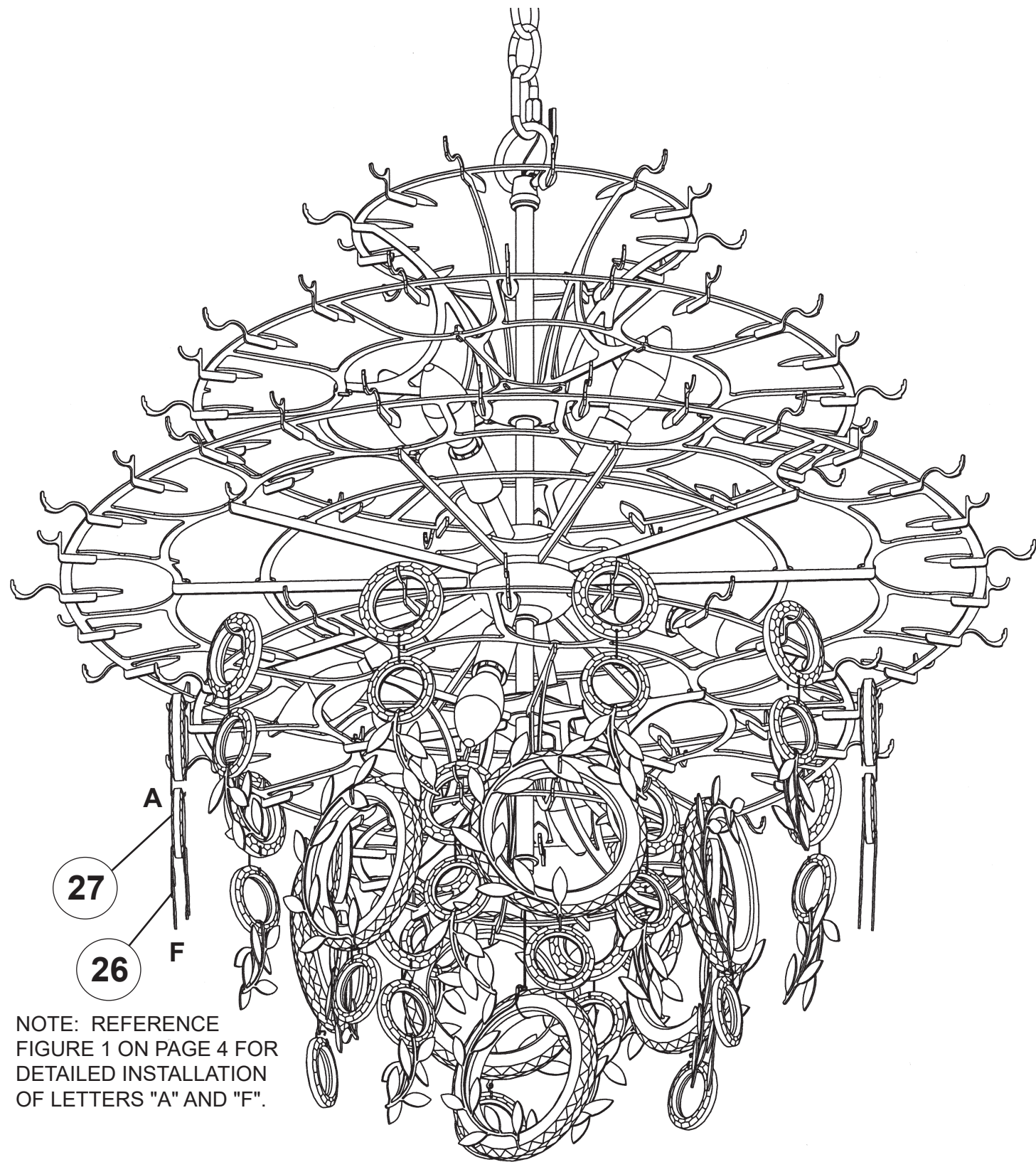

NOTE: REFERENCE
FIGURE 1 ON PAGE 4 FOR
DETAILED INSTALLATION
OF LETTERS "A" AND "F".

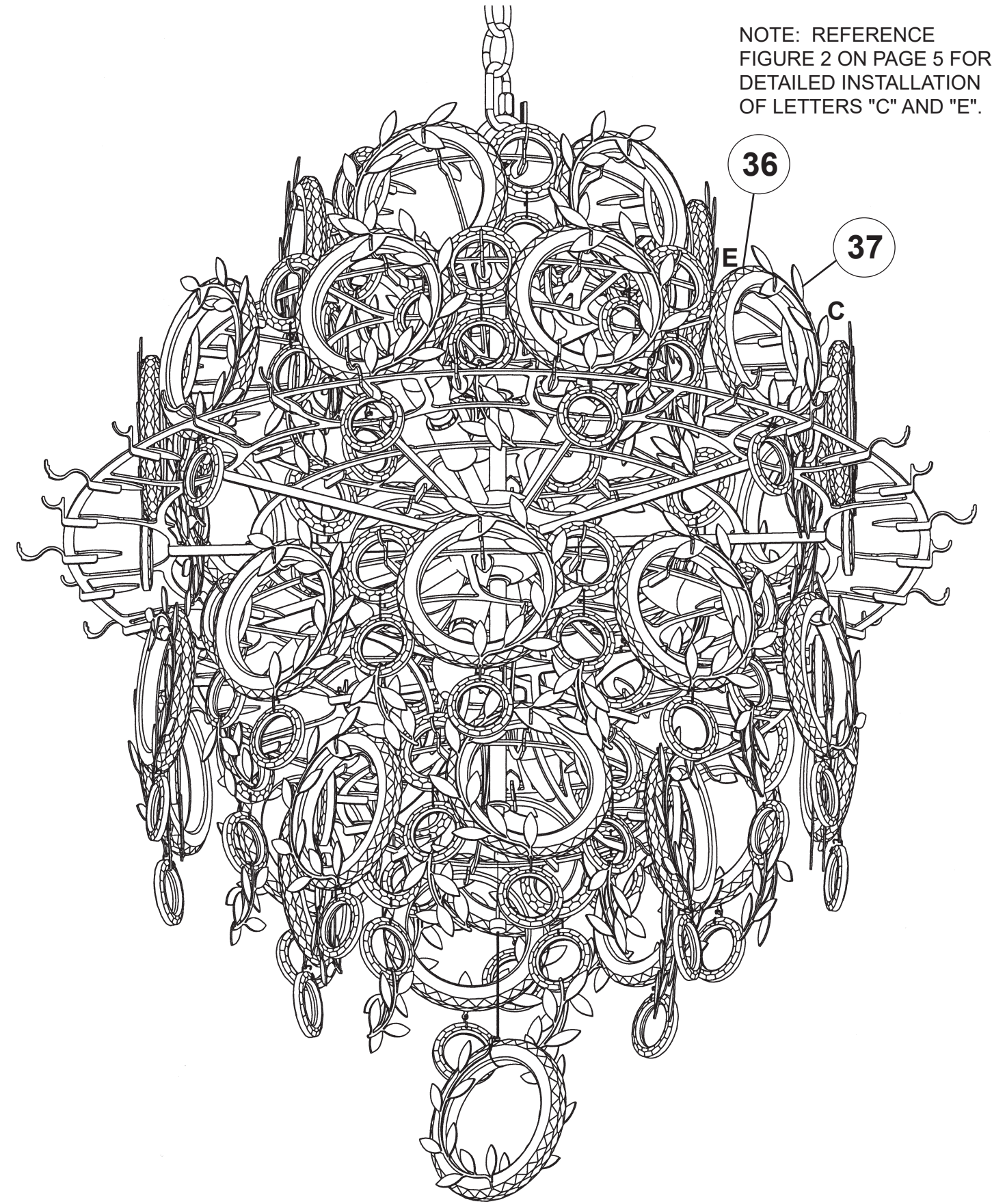

NOTE: REFERENCE
FIGURE 2 ON PAGE 5 FOR
DETAILED INSTALLATION
OF LETTERS "C" AND "E".

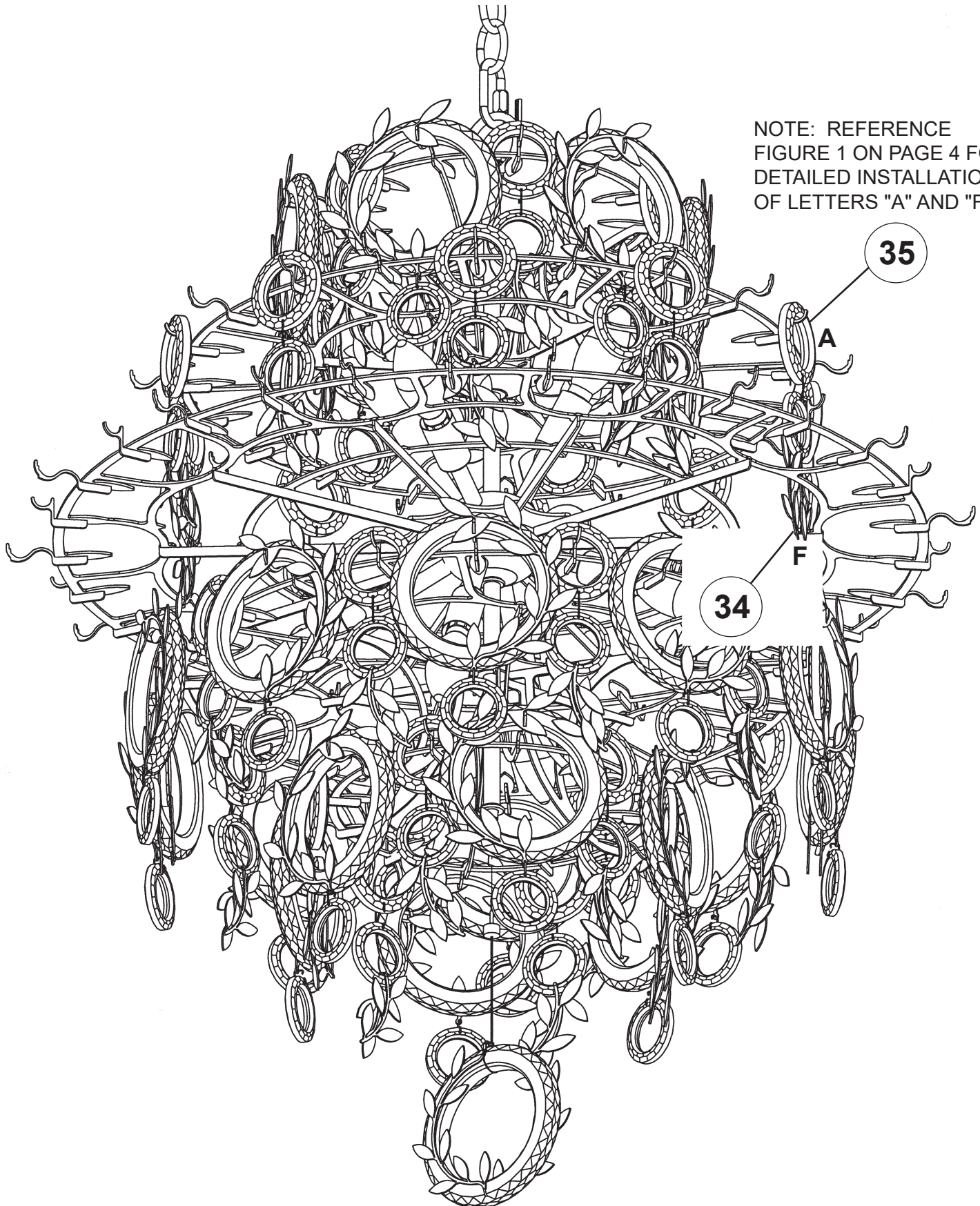

NOTE: REFERENCE
FIGURE 1 ON PAGE 4 FOR
DETAILED INSTALLATION
OF LETTERS "A" AND "F".

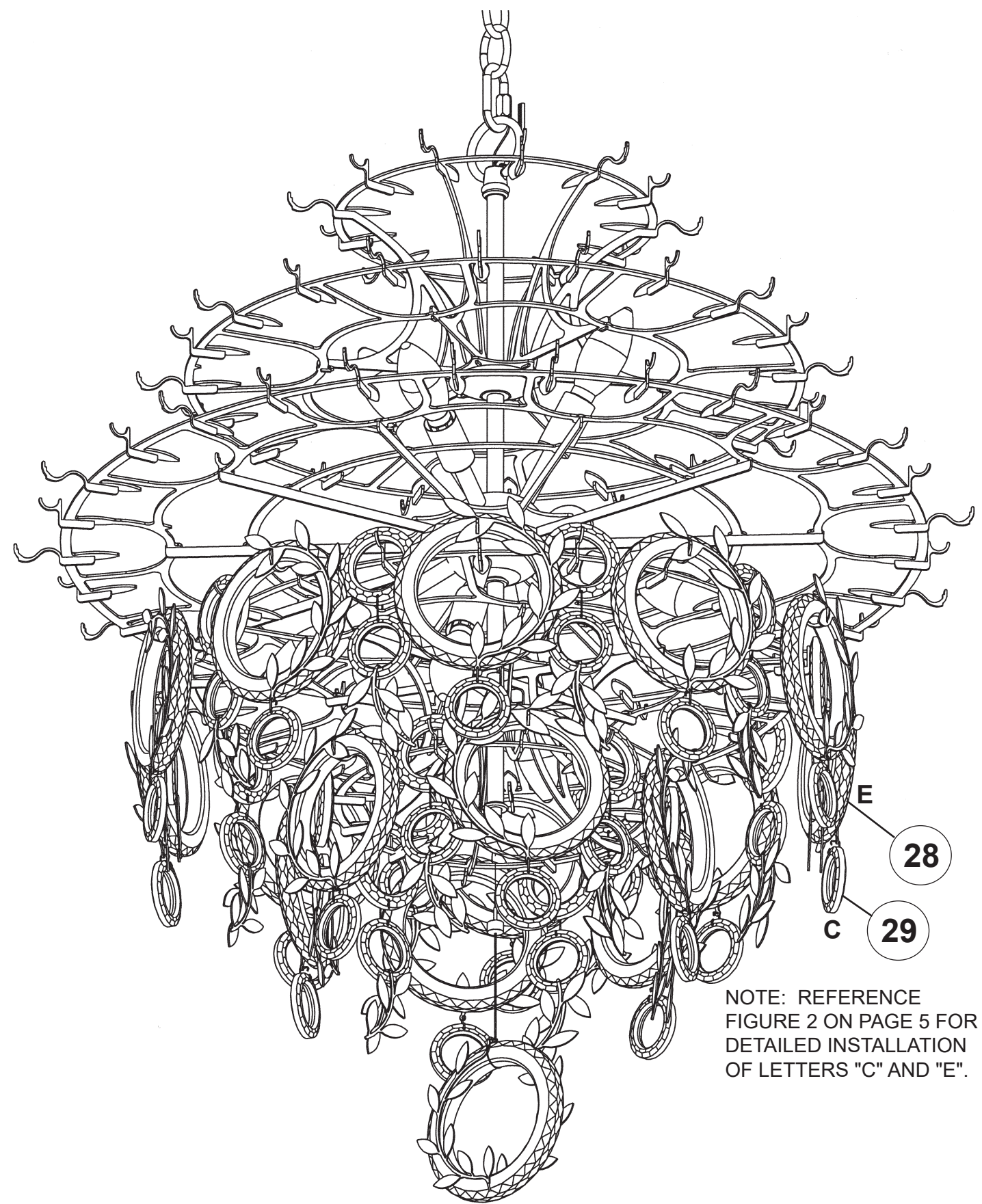

NOTE: REFERENCE
FIGURE 2 ON PAGE 5 FOR
DETAILED INSTALLATION
OF LETTERS "C" AND "E".

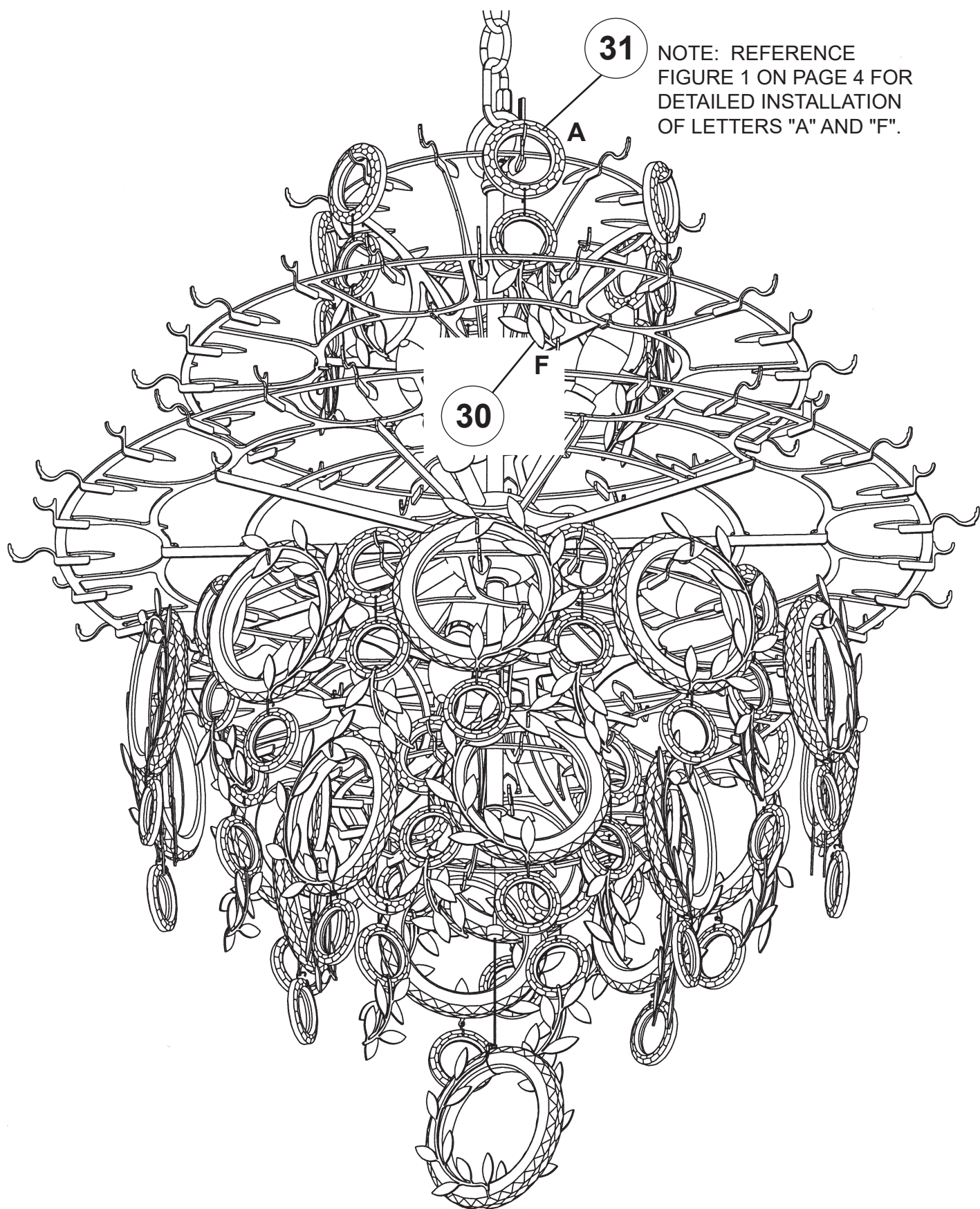

31 NOTE: REFERENCE
FIGURE 1 ON PAGE 4 FOR
DETAILED INSTALLATION
OF LETTERS "A" AND "F".

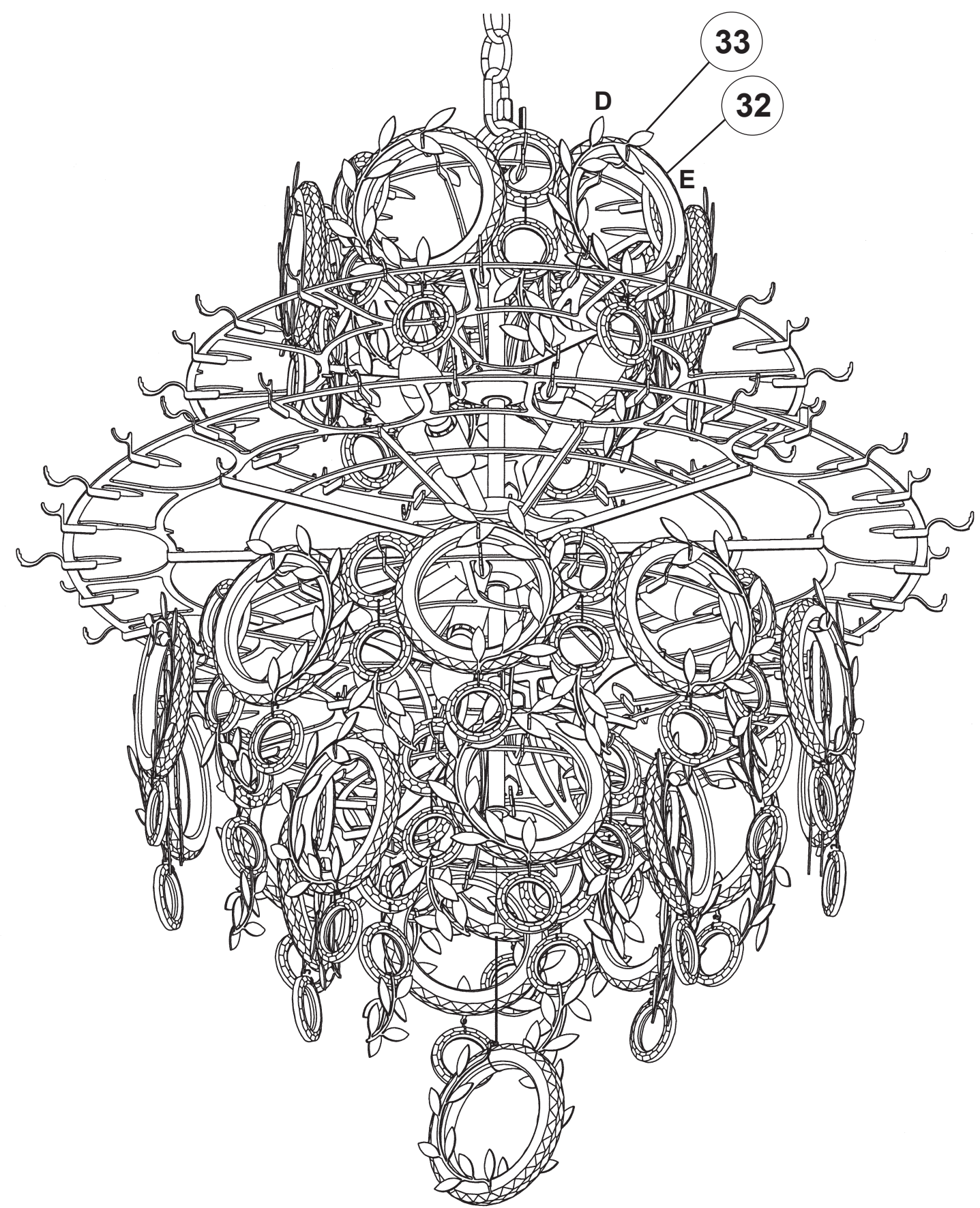

NOTE: REFERENCE
FIGURE 2 ON PAGE 5 FOR
DETAILED INSTALLATION
OF LETTERS "D" AND "E".