

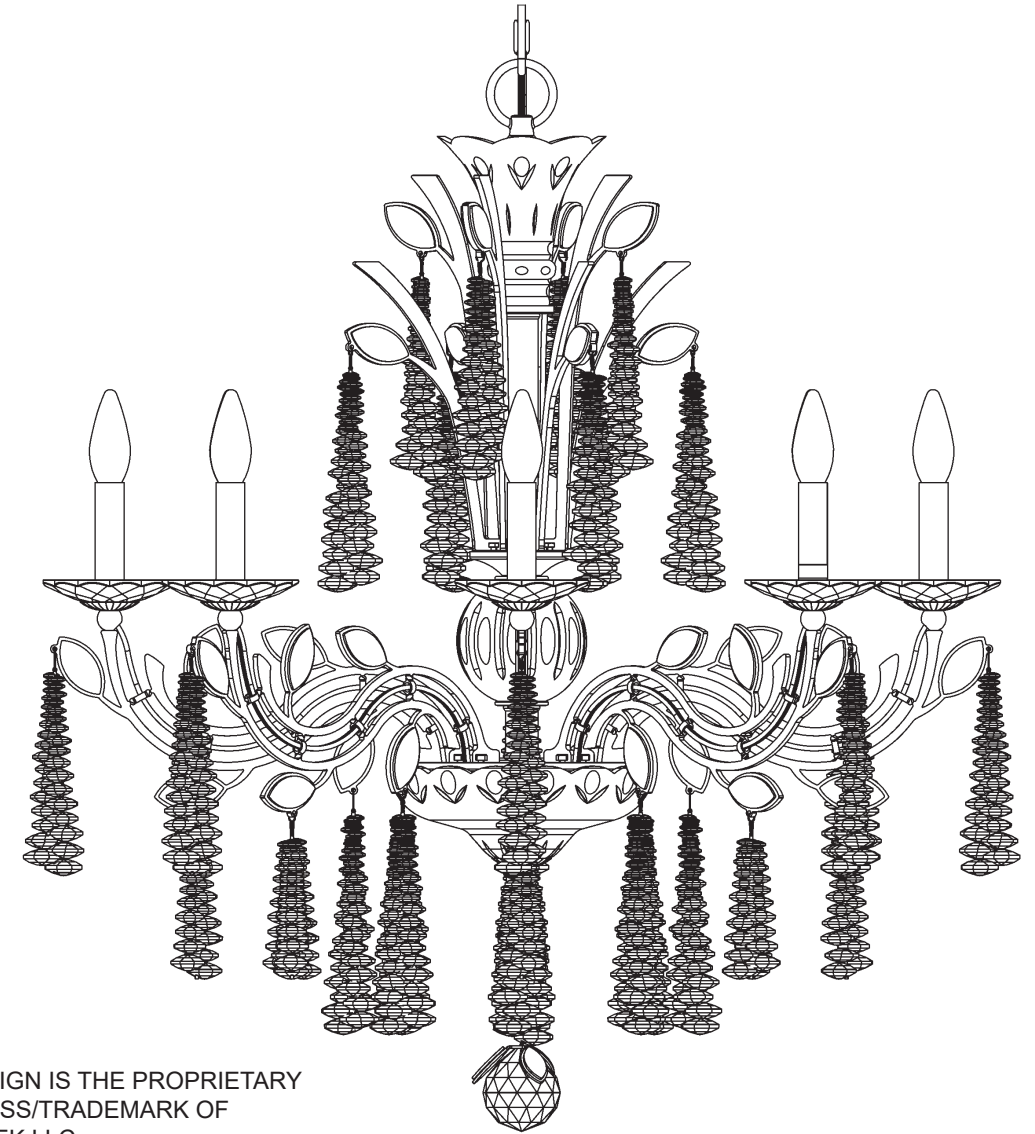









SCHONBEK
Signature[™]

MACLYN
S58508-__ __R



THIS DESIGN IS THE PROPRIETARY
TRADE DRESS/TRADEMARK OF
W SCHONBEK LLC.

SCHONBEK
Signature[™]

								
MAX <u>60</u> W	110-120 V							

WARNING:

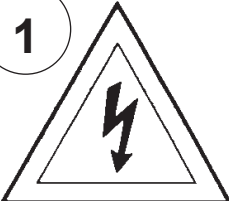
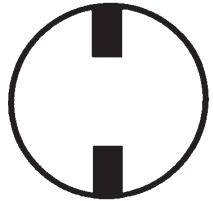
1  

Electrical Danger Turn Power Off

All electrical components must be installed by a licensed electrician in accordance with the National Electric Code and the appropriate local electrical codes.

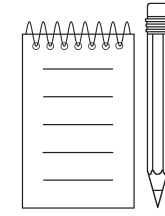
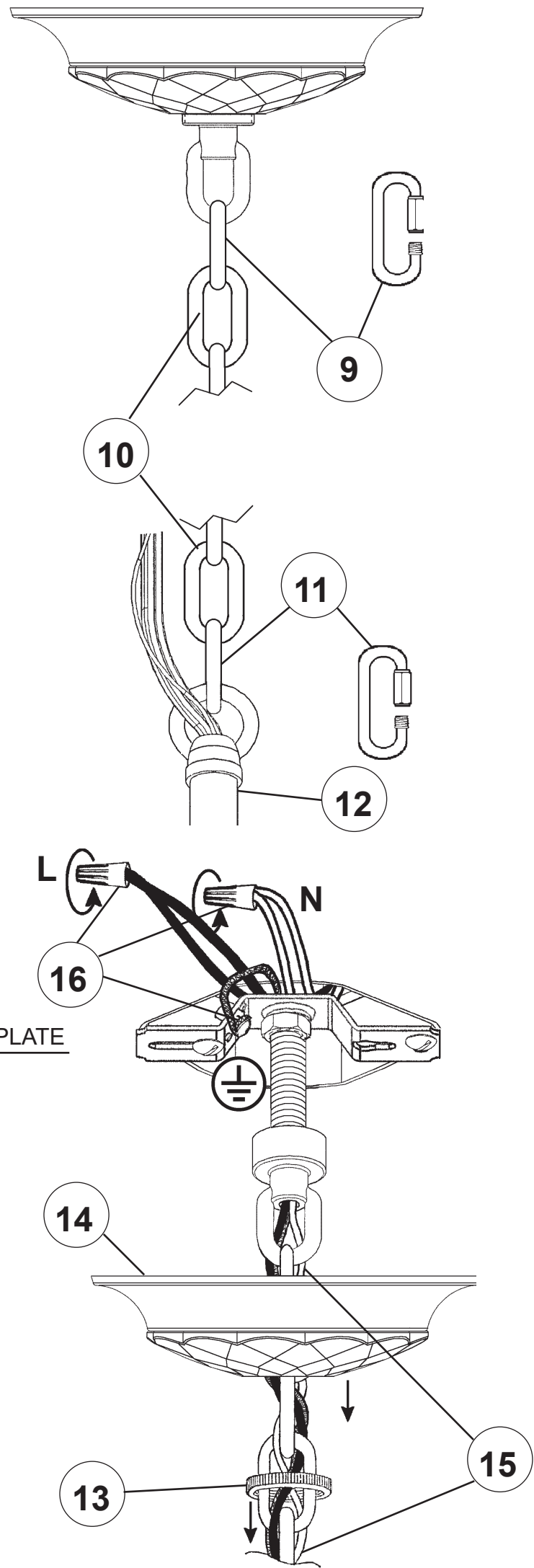
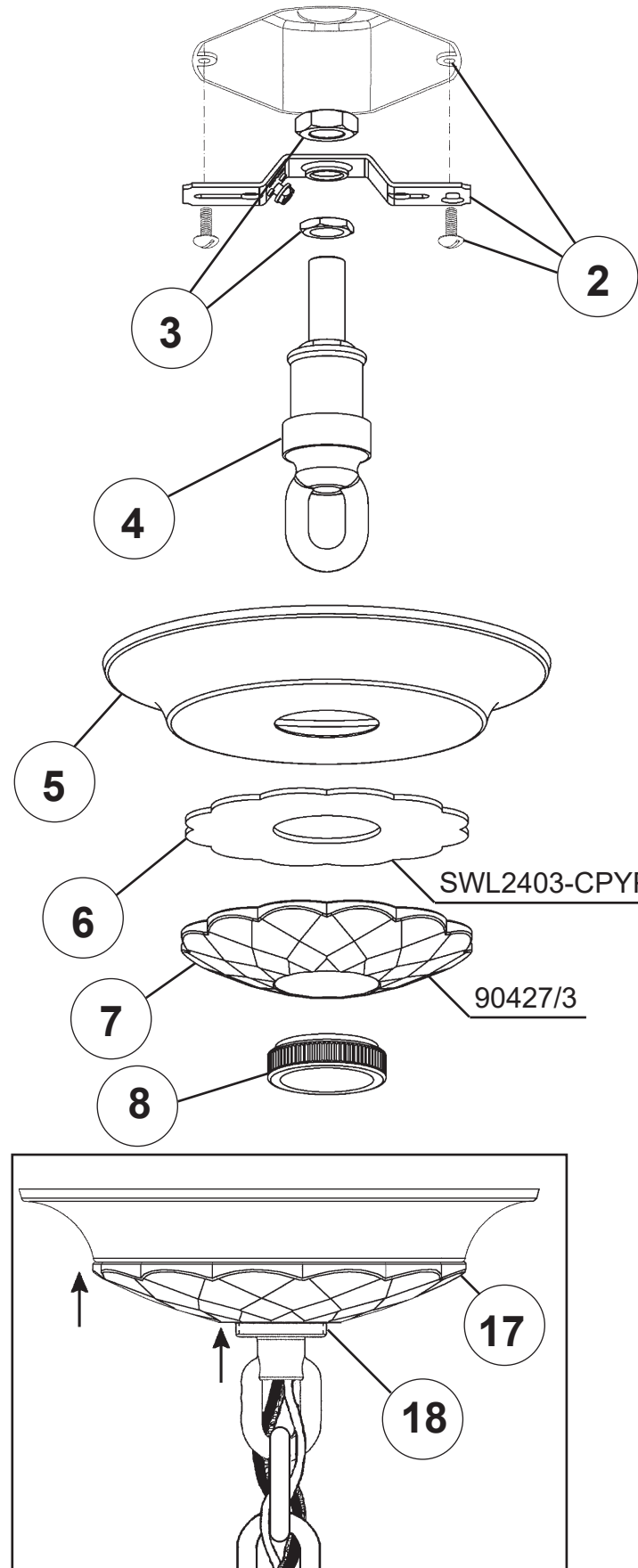

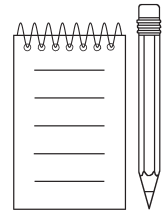

20

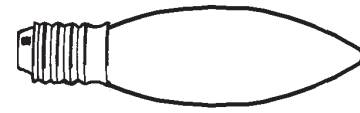

You will need 8 - B10
25 Watts Recommended
60 Watts Max

