

LED Product Information and Warnings

Important

- **Always disconnect the power before installing or replacing bulbs and before cleaning or other maintenance.**
- **Consult a qualified, licensed electrician to ensure correct branch circuit conductor.**
- Please read all included assembly instructions and warnings carefully before installation. Contact Customer Service if you have any questions or concerns. Before installation, please confirm that the fixture is compatible with your supply voltage and dimming system, if present.
- LEDs are highly sensitive electronic devices, and must be treated with care. Do not open any factory sealed compartments, and avoid touching the LEDs with your hands or any object.
- Although all our fixtures are equipped with protective devices, LED fixtures are vulnerable to power surges and supply variations. Do not install LED fixtures on the same circuit as any motors, appliances, or HVAC systems.
- Do not remove or bypass any LED Driver or Transformer that is provided with the fixture, and do not replace or substitute with another power supply.
- Remote LED Driver or Transformer installation must be done by a licensed electrician and in accordance with local codes. Remote installations should be in an accessible location, as close to the fixture as possible.
- Fixtures must be wired in parallel on independent leads; do not "daisy chain" multiple fixtures together or wire them in series.
- All factory-made splices and connections must remain intact. LED circuits are carefully designed and built, and improper connections may damage the fixture.
- The ends of coaxial pendant cords have been precisely stripped and split at the factory and must not be field cut. Excess cord or cable should be neatly coiled and reserved in the fixture canopy.
- Any mounting hardware is provided for your convenience and should be used with discretion. Always use the appropriate hardware for the mounting surface.

December 31, 2016

Assembly Instructions

CPY.2976

INSTRUCTIONS D'INSTALLATION
6 Light Canopy with Tri-Spreader Kit

Important

- Always disconnect the power before installing or replacing bulbs and before cleaning or other maintenance.
 - Consult a qualified, licensed electrician to ensure correct branch circuit conductor.
- Consulter un électricien qualifié pour vous assurer que les conducteurs de la dérivation sont adéquats.*

1. Shut off power to the outlet box (A).
2. Assemble the spreader (B) on a flat surface using the screws (C) (Fig. 1).
3. Refer to the corresponding pendant assembly instructions for any pendant preparation steps (if applicable).
4. Use the screwdriver (D) to loosen the set screws (E). Loop the outer cords (F) around the outer spacers (G) (Fig. 2) and feed them through the bushings (H) in the canopy (J). Adjust the cords to the desired length. Tighten the set screws to set.
5. Feed the inner cords (K) over the inner spacers (L) (Fig. 3) and feed them through the bushings (H) in the canopy (J). Adjust the cords (F&K) to the desired length.
6. Connect the fixture wires to the lever nuts (M) by pulling up on the lever for an empty slot (Fig. 4), inserting the wire, and pushing the lever back down to lock. The white inner conductor (N) and black outer conductor (P) on each cord (F&K) must be connected to separate lever nuts, as shown (Fig. 5).
7. Reserve transformer (Q), extra cords (F&K), and lever nuts (M) in canopy (J).
8. Make appropriate electrical connections using wire nuts:
 - a. Connect the transformer's (Q) live wire (black) to the live outlet box wire.
 - b. Connect the transformer's (Q) neutral wire (white) to the neutral outlet box wire.
 - c. Connect fixture's ground wire (green or uncoated) to the ground outlet box wire.
 - d. Carefully place connections in outlet box (A).
9. Attach mounting plate (R) to the outlet box (A), secure with outlet box screws (S).
10. Attach canopy (J) to nipple (T), secure with finial (U).
11. Adjust spreader (B) to desired height and level.

To raise spreader arm, pull down gently on the cord (F) just above the outer spacer (G), while lifting up on the end of the spreader arm. To lower spreader arm, lift up on the cord just below the outer spacer, while pulling down on the end of the spreader arm.

NOTE: Cords should be max 45 degrees from vertical above the spreader.
12. Complete fixture assembly per the corresponding pendant assembly instructions.

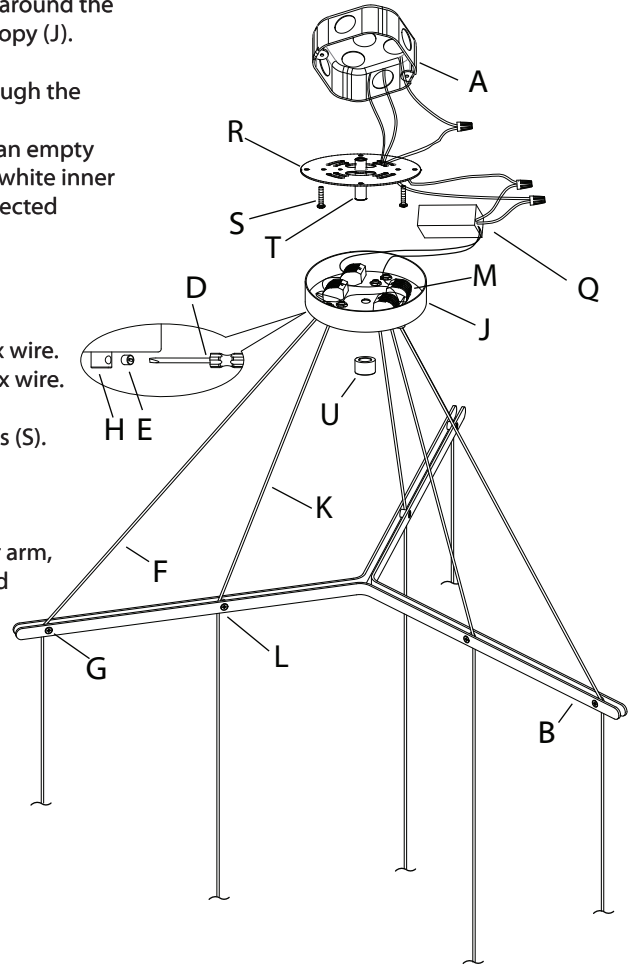

Note

- This fixture is dimmable with Electronic Low Voltage (Trailing-Edge) type dimmers only.

Care Instructions

- **Dusting:** Use a clean, dry cloth.
- **Cleaning:** To protect the finish, avoid any harsh abrasives or chemicals.

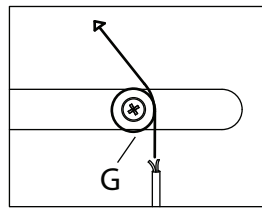
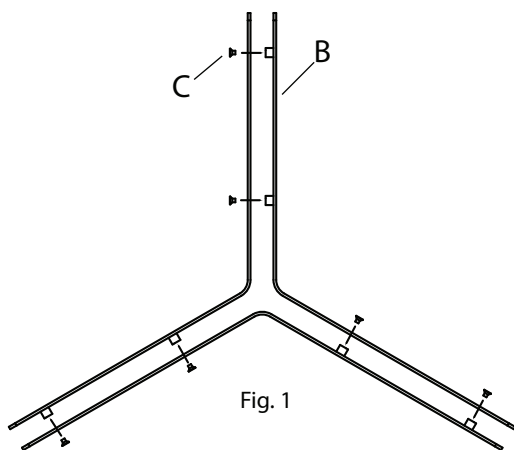

Fig. 2

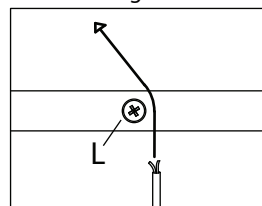

Fig. 3

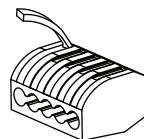

Fig. 4

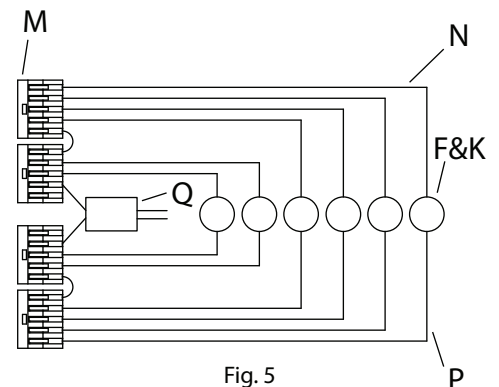

Fig. 5

Assembly Instructions

INSTRUCTIONS D'INSTALLATION

Cantina Series - Small Cordset, Medium Cordset, Large Cordset

CST.2990-SML
CST.2990-MED
CST.2990-LRG

Important

- Always disconnect the power before installing or replacing bulbs and before cleaning or other maintenance.
- Consult a qualified, licensed electrician to ensure correct branch circuit conductor.
Consulter un électricien qualifié pour vous assurer que les conducteurs de la dérivation sont adéquats.

1. Shut off power to the outlet box.
2. Install canopy and spreader (if applicable) using the corresponding assembly instructions.
3. Install included G4 LED Bulb (A).
4. Install glass (B) onto the fixture (C) using the threaded pins (D).
5. Restore power to the fixture.

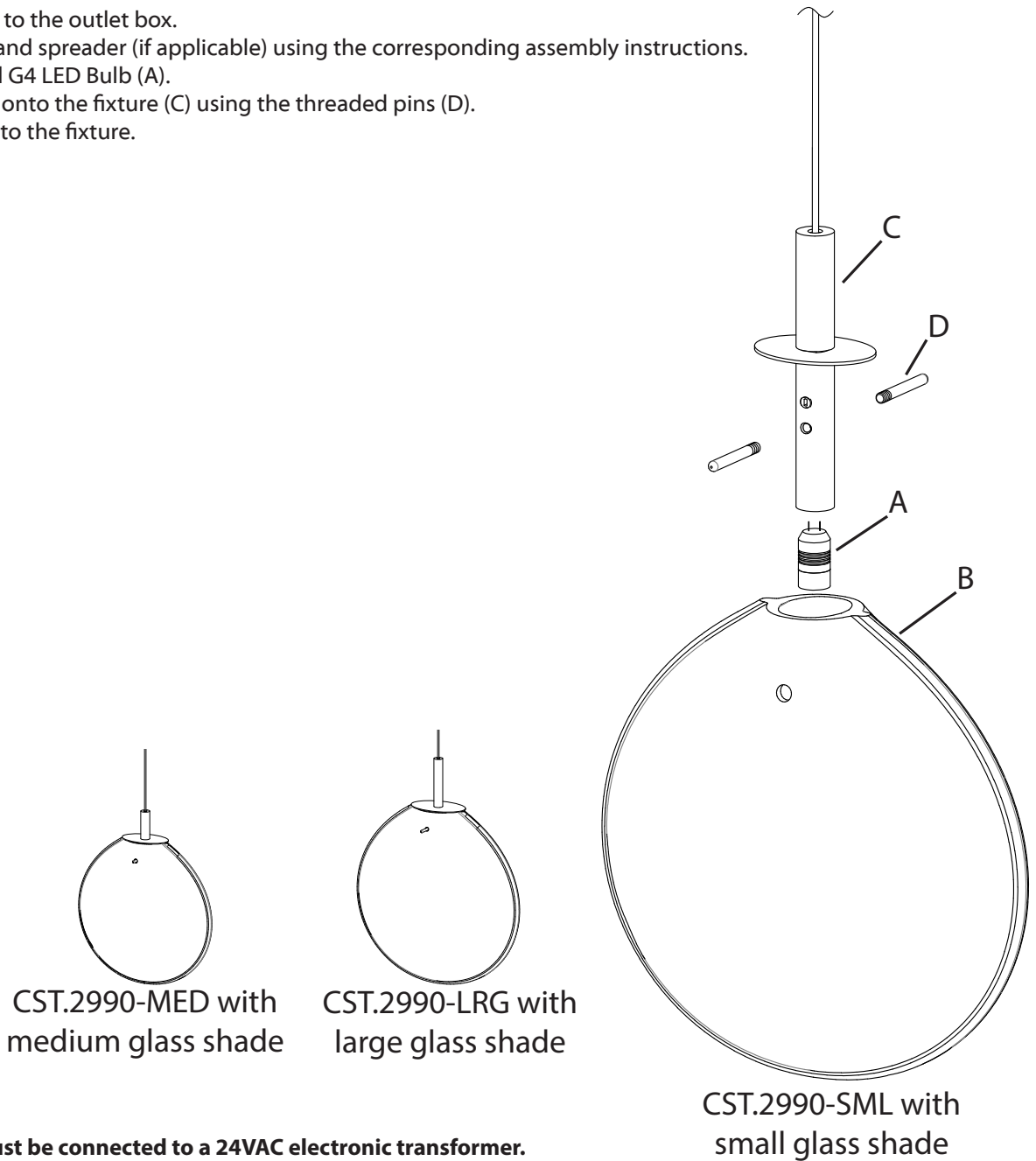

Note

- This fixture must be connected to a 24VAC electronic transformer.

Care Instructions

- **Dusting:** Use a clean, dry cloth.
- **Cleaning:** To protect the finish, avoid any harsh abrasives or chemicals.