

ELEMENT™ 3" LED

SHALLOW ADJUSTABLE DOWNLIGHT

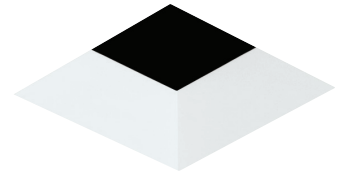

SHOWN IN FLANGELESS BEVEL SQUARE

The ELEMENT 3" LED Shallow Adjustable Downlight provides a beautiful architectural appearance and high lumen performance for shallow ceiling plenum installations. Designed with a shallow 3" housing with the same trims as the entire ELEMENT 3" platform for a consistent aesthetic. Ideal for space-constrained environments such as elevators and healthcare soffits. Featuring full adjustability with lockable, hot-aiming with 0°-40° tilt and 361° rotation to eliminate dead spots. Flangeless in wood ceiling option allows for a smooth appearance using any flangeless trim.

- Lockable, hot aiming with 0-40° tilt and 361° rotation
- Trims match the ELEMENT 3" platform
- Solite Soft Focus lens option
- Includes integral junction box approved for branch circuit through wiring
- IC-Rated, Airtight, Chicago Plenum
- Damp Listed, Shower version Wet Listed

LUMEN MULTIPLIER (CRI/CCT)

CCT	80 CRI MULTIPLIER	90 CRI MULTIPLIER
2700K	0.95	0.80
3000K	1.00	0.85
3500K	1.05	0.90

Lumen output will vary by CCT and CRI.
See photometric charts for output information.

SPECIFICATIONS

	STATIC WHITE				WARM DIM	
	HIGH OUTPUT		LOW OUTPUT		HIGH OUTPUT	LOW OUTPUT
DELIVERED LUMENS	1800	1450	1319	1124	1300	900
WATTS	17	17	12	12	17	12
EFFICACY	106	85	110	94	76	75
CRI	80+	90+	80+	90+	90+	
CBCP	10° - 19,414 18° - 5,848 25° - 5,416 40° - 3,230 60° - 2,305				18° - N/A 25° - N/A 40° - 1,622 60° - N/A	
CCT	2700K, 3000K, or 3500K				3000K - 1800K	
COLOR CONSISTENCY	2-step				3-step	
VOLTAGE	120V or 277V					
DIMMING ¹	Standard reverse-phase, forward-phase, TRIAC, and 0-10V dimming (down to 1%)					
POWER SUPPLY	Constant current driver with +.9 power factor and +80% efficiency					
OPTICS	Field changeable: 10°, 18°, 25°, 40°, or 60° TIR				Field changeable: 18°, 25°, 40°, or 60° TIR	
ADJUSTABILITY	Lockable, hot-aiming, 0-40° tilt, 361° rotation					
CEILING APPEARANCE	Flanged, flangeless or flangeless in wood ceiling					
CEILING THICKNESS	Flanged: Up to 2-1/2" Flangeless: No ceiling thickness limitations Flangeless in wood ceiling: 1/2" to 1-1/2" Note: Thicker ceilings impact light cutoff					
CEILING APERTURE	3-7/8" ceiling cutout					
HOUSING	IC Rated, Airtight, Chicago Plenum. IC suitable up to R60 spray foam insulation. Sauna/steam-room use available only with combination of H shower trim, LO Low output housing and S IC Airtight housing rating.					
CONSTRUCTION	Housing: Heavy-gauge, cold-rolled steel Trim: Die-cast aluminum					
FINISH	Housing: Black powder coat Trim: Antique Bronze, Black, Satin Nickel, or White (paintable)					
GENERAL LISTINGS	ETL Listed. Damp Location. Shower version Wet Listed.					
CALIFORNIA TITLE 24	Registered CEC Appliance Database. Complies with CEC 2019 Title 24 Part 6 (JA8-2016, JA8-2019) (for 90 CRI versions).					
L70	50,000 hours min					
WARRANTY ²	5 years					

Data in chart reflect 3000K/80 CRI values unless noted.

Custom output/custom RAL/custom CCT available, contact Quotes Department

Ordering grids available on page 2.

Accepts two optical controls and an optional trim-mounted lens.

¹See visualcomfort.com for dimmer compatibility.

²Visit visualcomfort.com for specific warranty limitations and details.

ELEMENT™ 3" LED

SHALLOW ADJUSTABLE DOWNLIGHT

ORDERING GRIDS

HOUSING

PRODUCT	CEILING APPEARANCE	LAMP	CRI/CCT	BEAM SPREAD	FUNCTION	HOUSING RATING	DRIVER
E3R ELEMENT 3" ROUND	LF FLANGELESS	-LH HIGH OUTPUT, 17W ²	827 80 CRI, 2700K, 2-STEP	0 10° ⁴	A ADJUSTABLE	SH SHALLOW IC	INTEGRATED DRIVERS 120V/277V
E3S ELEMENT 3" SQUARE	FF FLANGED	-LO LOW OUTPUT, 12W ³	830 80 CRI, 3000K, 2-STEP	1 18°		CSH SHALLOW CHICAGO PLENUM	UNIVERSAL PHASE/0-10V 1% (LEAVE BLANK) ⁵
	WC WOOD CEILING ¹		835 80 CRI, 3500K, 2-STEP	2 25°			
			927 90 CRI, 2700K, 2-STEP	4 40°			
			930 90 CRI, 3000K, 2-STEP	6 60°			
			935 90 CRI, 3500K, 2-STEP				
			WD 90 CRI, 3000-1800K, WARM DIM, 3-STEP				

Trims are required and must be ordered separately.

For dimmer details, refer to dimmer compatibility chart.

¹WC - Wood ceiling option accommodates flangeless trims only.

²LH - High output available for wet rated. Not rated for sauna/steam-room.

³LO - Sauna/steam-room use available only with combination of H shower trim, LO low output housing, and S IC Airtight housing rating.

⁴0 - 10° optic has a unique LED module not available with warm dim. To change optics to 18°, 25°, 40°, or 60° a new LED module is required; contact Customer Service.

⁵Universal dimming is reverse-phase, forward-phase, TRIAC and 0-10V. 277V is only compatible with 0-10V dimming.

TRIM

PRODUCT	CEILING APPEARANCE	STYLE	APERTURE	FINISH
E3R ELEMENT 3" ROUND	L FLANGELESS	B BEVEL	-O NO LENS	Z ANTIQUE BRONZE
E3S ELEMENT 3" SQUARE	F FLANGED UP TO 1" CEILING THICKNESS	F FLAT	-H SHOWER ¹	B BLACK
	F15 FLANGED 1.1"-1.5" CEILING THICKNESS		-L LENSED	S SATIN NICKEL
	F20 FLANGED 1.6"-2.0" CEILING THICKNESS			W WHITE
	F25 FLANGED 2.1"-2.5" CEILING THICKNESS			

Wood ceiling option accommodates flangeless trims only.

¹H - Sauna/steam-room use available only with combination of H shower trim, LO low output housing, and S IC Airtight housing rating.

WALL WASH TRIM

PRODUCT	CEILING APPEARANCE	FUNCTION	APERTURE	LED
E3R ELEMENT 3" ROUND	L FLANGELESS	W WALL WASH	-Z ANTIQUE BRONZE	-LED
E3S ELEMENT 3" SQUARE	F FLANGED		-B BLACK	
	WC WOOD CEILING ¹		-S SATIN NICKEL	
			-W WHITE	

¹WC - Wood ceiling option accommodates WC flangeless trims only.

REPLACEMENT OPTICS

PRODUCT	BEAM SPREAD
353E4LEDCOPT	18 18°
	25 25°
	40 40°
	60 60°

353E4LEDCOPT

PLASTER PLATES¹

PRODUCT	
150E3RPPLT-A	3" PLASTER PLATE ROUND DIE-CAST METAL ¹
150E3SPPLT-A	3" PLASTER PLATE SQUARE DIE-CAST METAL ¹
150E3RTPPLT-W	3" PLASTER PLATE ROUND SHEET METAL ²
150E3STPPLT-W	3" PLASTER PLATE SQUARE SHEET METAL ²

Plaster plates are used to convert flanged housings into flangeless housings.

¹Ships standard with flangeless housings. Round not compatible with Lutron Hi-Lume or eldoLED drivers.

²Optional, thinner, meshed sheet metal mud plates available for minimized plaster feathering to meet installer preference. Round not compatible with Lutron Hi-Lume or eldoLED drivers. Square not compatible with eldoLED drivers.



ELEMENT™ 3" LED

SHALLOW ADJUSTABLE DOWNLIGHT

TRIMS

FLANGED

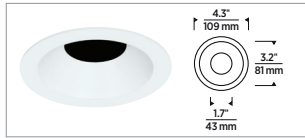

ROUND BEVEL

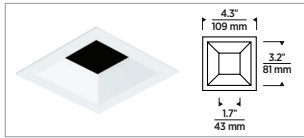

SQUARE BEVEL

FLANGELESS

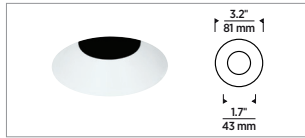

ROUND BEVEL

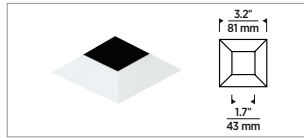

SQUARE BEVEL

FINISH



ANTIQUE BRONZE



BLACK



SATIN NICKEL



WHITE (PAINTABLE)

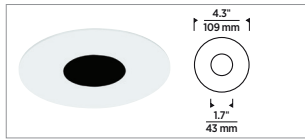

ROUND FLAT

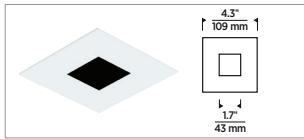

SQUARE FLAT

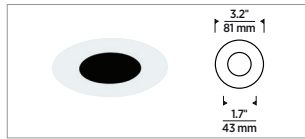

ROUND FLAT

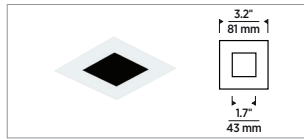

SQUARE FLAT

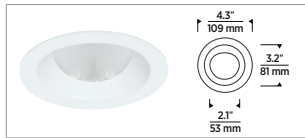

ROUND WALL WASH

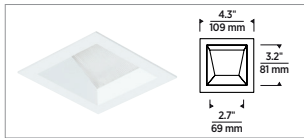

SQUARE WALL WASH



ROUND WALL WASH

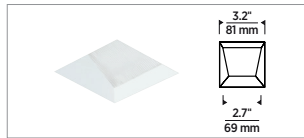

SQUARE WALL WASH

FLANGELESS IN WOOD CEILING



ROUND BEVEL (ANTIQUE BRONZE)

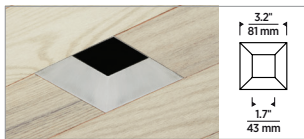

SQUARE BEVEL (SATIN NICKEL)

LENS OPTION



SHOWN WITH AND WITHOUT A LENS (SQUARE FLANGED BEVEL)



ROUND FLAT (ANTIQUE BRONZE)



SQUARE FLAT (SATIN NICKEL)



SHOWN WITH AND WITHOUT A LENS (ROUND FLANGELESS BEVEL)



ROUND WALL WASH (ANTIQUE BRONZE)



SQUARE WALL WASH (SATIN NICKEL)



ELEMENT™ 3" LED

SHALLOW ADJUSTABLE DOWNLIGHT

WARM DIM CURVE

CCT vs. Forward Current, $T_c=25^{\circ}\text{C}$

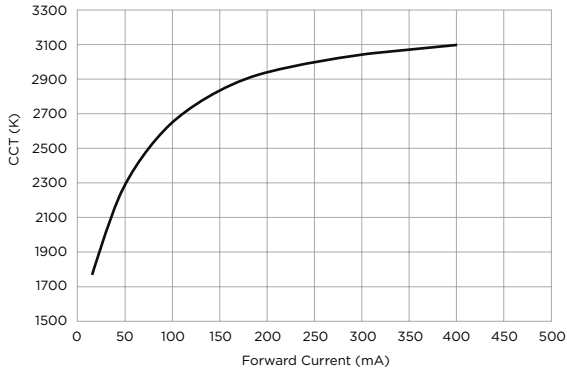

HOUSING

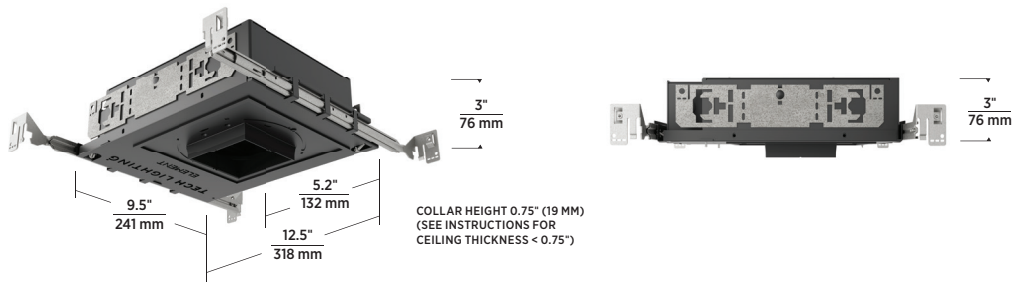

IC AIRTIGHT / CHICAGO PLENUM

ELEMENT™ 3" LED

SHALLOW ADJUSTABLE DOWNLIGHT

PLASTER PLATES

INCLUDED DIE-CAST

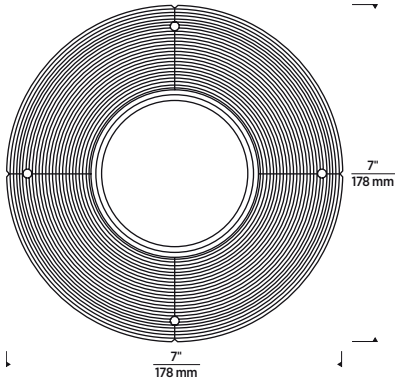

ROUND DIE-CAST (INCLUDED FOR FLANGELESS INSTALLATION)

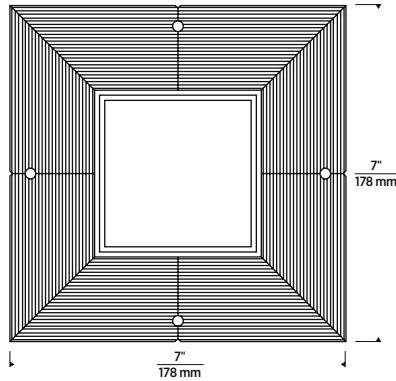

SQUARE DIE-CAST (INCLUDED FOR FLANGELESS INSTALLATION)

OPTIONAL SHEET METAL

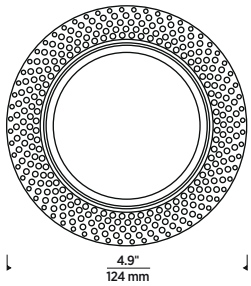

ROUND SHEET METAL (OPTIONAL FOR FLANGELESS INSTALLATION)

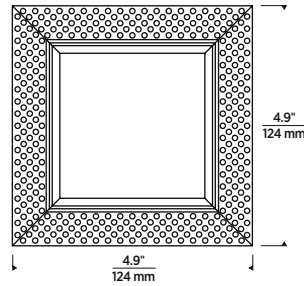

SQUARE SHEET METAL (OPTIONAL FOR FLANGELESS INSTALLATION)

FLANGELESS IN WOOD CEILING TRIM ADAPTER

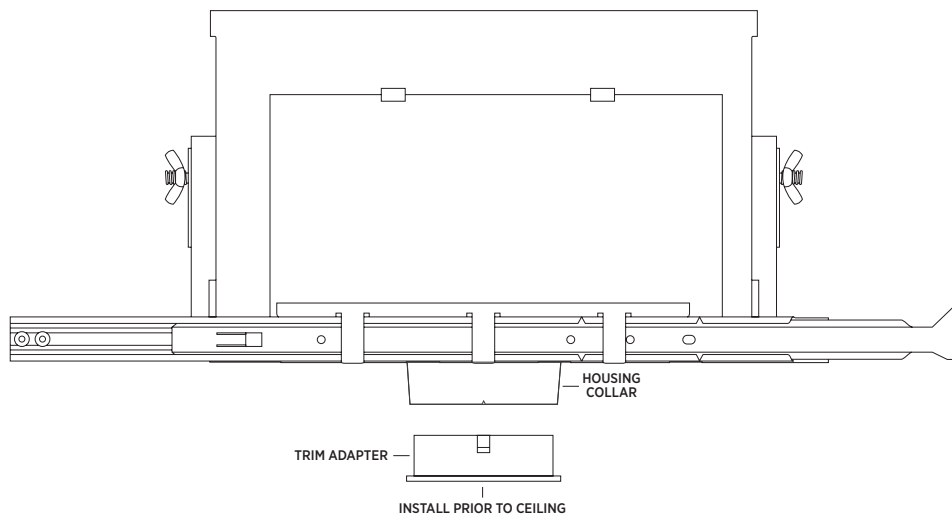

TRIM ADAPTER INSTALLED

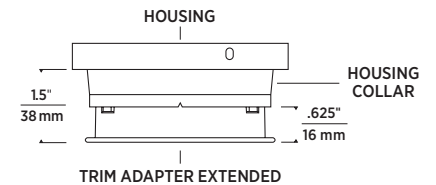
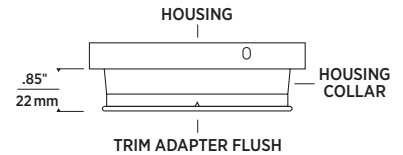

Wood ceiling housings ("WC" designation in the ordering grid) ship with an adjustable trim adapter that inserts into the housing aperture and allows standard ELEMENT 3" flangeless trims to achieve a truly flangeless, flush ceiling appearance in special applications such as wood or stone installation. For use in new construction. Consult installation instructions regarding plenum requirements and ceiling thickness ratios.

ELEMENT™ 3" LED

SHALLOW ADJUSTABLE DOWNLIGHT

PHOTOMETRICS

Description: 3" LED Module
10° Beam - 0° Tilt,
80 CRI, 3000K

Model: E3 Citizen LED

Input Power (Watts): 16.3

Input Power Factor: 0.98

Absolute Luminous Flux (Lumens): 1337

Lumen Efficacy (Lumens per Watt): 82

Description: 3" LED Module
18° Beam - 0° Tilt,
80 CRI, 3000K

Model: E3 Citizen LED

Input Power (Watts): 18.1

Input Power Factor: 0.98

Absolute Luminous Flux (Lumens): 1598

Lumen Efficacy (Lumens per Watt): 88.1

Description: 3" LED Module
25° Beam - 0° Tilt,
80 CRI, 3000K

Model: E3 Citizen LED

Input Power (Watts): 18.3

Input Power Factor: 0.98

Absolute Luminous Flux (Lumens): 1754

Lumen Efficacy (Lumens per Watt): 95.5

Output difference between CCTs - 5%, CRIs - 15%.

ANGLE	0°	45°	90°
0°	19414	19414	19414
5°	10254	10254	10254
10°	3511	3511	3511
15°	1342	1342	1342
20°	383	383	383
25°	126	126	126
30°	84	84	84
35°	54	54	54
40°	31	31	31
45°	22	22	22
50°	18	18	18
55°	11	11	11
60°	6	6	6
65°	3	3	3
70°	2	2	2
75°	0	0	0
80°	0	0	0
85°	0	0	0
90°	0	0	0

ANGLE	0°	45°	90°
0°	5848	5848	5848
5°	5500	5478	5491
10°	3919	3944	3905
15°	2103	2212	2149
20°	1058	1199	1075
25°	507	548	508
30°	250	237	250
35°	148	140	141
40°	93	98	94
45°	51	69	61
50°	33	46	37
55°	21	27	24
60°	4	15	10
65°	2	3	2
70°	2	2	2
75°	0	0	0
80°	0	0	0
85°	0	0	0
90°	0	0	0

ANGLE	0°	45°	90°
0°	5422	5416	5427
5°	4916	4872	4888
10°	3800	3718	3721
15°	2040	2115	2016
20°	870	979	900
25°	400	441	414
30°	190	190	196
35°	103	103	105
40°	60	65	61
45°	27	43	31
50°	16	25	17
55°	7	12	7
60°	2	5	2
65°	2	2	2
70°	1	1	2
75°	0	0	0
80°	0	0	0
85°	0	0	0
90°	0	0	0

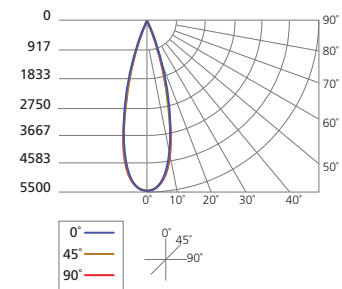
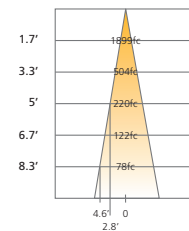
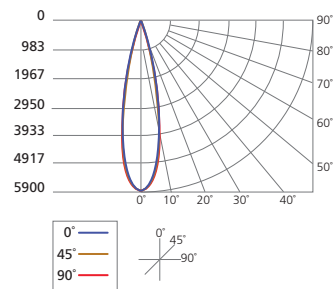
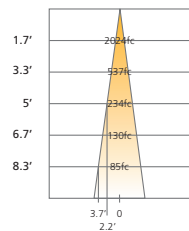
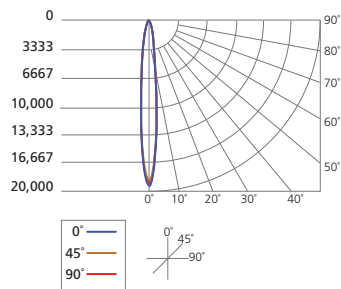
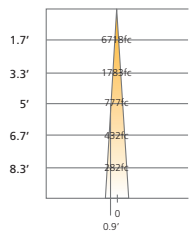

ELEMENT™ 3" LED

SHALLOW ADJUSTABLE DOWNLIGHT

PHOTOMETRICS

Description: 3" LED Module
 40° Beam - 0° Tilt,
 80 CRI, 3000K

Model: E3 Citizen LED

Input Power (Watts): 16.9

Input Power Factor: 0.98

Absolute Luminous

Flux (Lumens): 1774

Lumen Efficacy

(Lumens per Watt): 104.6

Output difference between CCTs - 5%, CRIs - 15%.

Description: 3" LED Module
 60° Beam - 0° Tilt,
 80 CRI, 3000K

Model: E3 Citizen LED

Input Power (Watts): 18.4

Input Power Factor: 0.98

Absolute Luminous

Flux (Lumens): 1536

Lumen Efficacy

(Lumens per Watt): 83.5

ANGLE	0°	45°	90°
0°	3230	3230	3230
5°	3107	3126	3159
10°	2824	2830	2871
15°	2415	2407	2463
20°	1863	1866	1937
25°	1111	1125	1128
30°	490	521	479
35°	221	232	205
40°	115	114	110
45°	65	64	59
50°	30	38	22
55°	14	22	11
60°	6	9	4
65°	1	3	1
70°	1	1	1
75°	1	1	1
80°	0	0	0
85°	0	0	0
90°	0	0	0

ANGLE	0°	45°	90°
0°	2305	2305	2305
5°	2313	2298	2268
10°	2295	2248	2155
15°	2219	2116	1938
20°	1964	1876	1714
25°	1548	1544	1330
30°	1113	1176	1013
35°	749	835	704
40°	450	511	428
45°	230	283	221
50°	94	140	91
55°	38	69	35
60°	18	31	16
65°	8	13	6
70°	0	4	0
75°	0	0	0
80°	0	0	0
85°	0	0	0
90°	0	0	0

