

ELEMENT™ 3" LED

WALL WASH

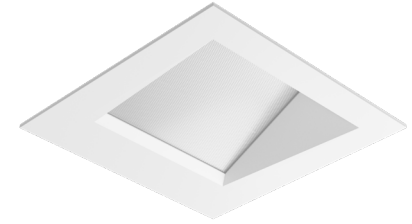

SHOWN IN FLANGED WALL WASH SQUARE

The ELEMENT 3" Wall Wash provides best-in-class performance for a smooth and consistent flood of illumination vertically and horizontally along the wall without scalloping or hot spots, eliminating shadowing. Engineered with high lumen output, ELEMENT Wall Wash downlights are a great solution for illuminating large vertical surface areas and highlighting multiple focal points, texture and design.

- Luminix turning film, two directions
- Even vertical and horizontal illumination of wall
- High efficacy: 77 lumens per watt
- Standard phase dimming (down to 1%)

LUMEN MULTIPLIER (CRI/CCT)

CCT	80 CRI MULTIPLIER	90 CRI MULTIPLIER
2700K	0.95	0.80
3000K	1.00	0.85
3500K	1.05	0.90

Lumen output will vary by CCT and CRI.
See photometric charts for output information.

SPECIFICATIONS

	STATIC WHITE				WARM DIM		TUNABLE WHITE	
	HIGH OUTPUT		LOW OUTPUT		HIGH OUTPUT	LOW OUTPUT	HIGH OUTPUT (5000K)	HIGH OUTPUT (4000K)
DELIVERED LUMENS	1342	942	853	675	900	600	870	800
WATTS	17	17	12	12	17	12	15	15
EFFICACY	79	51	70	56	53	50	59	53
CRI	80+	90+	80+	90+	90+		90+	
CCT	2700K, 3000K, or 3500K				3000K - 1800K		5000K - 2700K	4000K - 1800K
COLOR CONSISTENCY	2-step				3-step		2-step	
VOLTAGE	120V or 277V							
DIMMING ¹	Standard reverse-phase, forward-phase, TRIAC and 0-10V dimming (down to 1%) eldoLED 0-10V or DALI-2 (down to 0.1%) Lutron has placed their LTEA (2-Wire) and 0.1% PEQ eco drivers on indefinite hold. Please consult Factory for alternative Lutron drivers (e.g. LDE 1%) or other driver solutions.						eldoLED 0-10V or DALI-2 (down to 0.1%)	
POWER SUPPLY	Constant current driver with +.9 power factor and +80% efficiency							
OPTICS	Luminix Turning Film, 2 directions							
ADJUSTABILITY	360° rotation, 45° collar rotation							
CEILING APPEARANCE	Flanged, flangeless or flangeless in wood ceiling							
CEILING THICKNESS	Flanged: Up to 2-1/2" (round flanged up to 1") Flangeless: No ceiling thickness limitations Flangeless in wood ceiling: 1/2" to 1-1/2"							
CEILING APERTURE	3-7/8" ceiling cutout							
HOUSING	IC Airtight, Chicago Plenum. IC suitable up to R60 spray foam insulation.							
CONSTRUCTION	Housing: Heavy-gauge, cold-rolled steel Trim: Die-cast aluminum							
FINISH	Housing: Black powder coat Trim: Antique Bronze, Black, Satin Nickel, or White (paintable)							
GENERAL LISTINGS	ETL Listed, Wet Listed.							
CALIFORNIA TITLE 24	Registered CEC Appliance Database. Can be used to comply with CEC 2019 Title 24 Part 6 (JA8-2016, JA8-2019) (for 90 CRI versions).							
L70	50,000 hours min							
WARRANTY ²	5 years							

Data in chart reflect 3000K/80 CRI values unless noted.

Custom output/custom RAL/custom CCT available, contact Quotes Department

Ordering grids available on page 2.

¹See ELEMENT-Lighting.com for dimmer compatibility.

²Visit ELEMENT-Lighting.com for specific warranty limitations and details.

³4000K - 1800K available as custom option only. Please consult Quotes Department.

ELEMENT™ 3" LED

WALL WASH

ORDERING GRIDS

HOUSING

PRODUCT	CEILING APPEARANCE	FUNCTION	OUTPUT	HOUSING RATING	DRIVER
E3R ELEMENT 3" ROUND	L FLANGELESS	W WALL WASH	-LH HIGH OUTPUT, 17W	I IC AIRTIGHT	INTEGRATED DRIVERS 120V/277V
E3S ELEMENT 3" SQUARE	F FLANGED WC WOOD CEILING ¹		-LO LOW OUTPUT, 12W	C CHICAGO PLENUM	UNIVERSAL PHASE/0-10V 1% (LEAVE BLANK) ²
					-ELDO ELDOLED 0.1% 0-10V LINEAR ³
					-ELDOA ELDOLED 0.1% 0-10V LOGARITHMIC ³
					-ELDD ELDOLED 0.1% DALI-2 ³
					-ELTO ELDOLED TUNABLE WHITE 0.1% 0-10V LINEAR ^{3,4}
					-ELTD ELDOLED TUNABLE WHITE 0.1% DALI-2 ^{3,4}
		W	-		

Trims are required and must be ordered separately.

For dimming details, refer to dimmer compatibility chart.

¹WC - Wood ceiling option accommodates flangeless trims only.

²Universal dimming is reverse-phase, forward-phase, TRIAC and 0-10V. 277V is only compatible with 0-10V dimming.

³EldoLED drivers not compatible with round flangeless (E3RL) or round wood ceiling (E3RWC) housings.

⁴ELTO/ELTD - Tunable white only available in high output, only available with ELTO (0-10V, linear), or ELTD (DALI-2). For 0-10V logarithmic dimming consult Quotes Department.

Lutron has placed their LTEA (2-Wire) and 0.1% PEQ eco drivers on indefinite hold. Please consult Factory for alternative Lutron drivers (e.g. LDE 1%) or other driver solutions.

TRIM

PRODUCT	CEILING APPEARANCE	FUNCTION	LAMP	FINISH
E3R ELEMENT 3" ROUND	L FLANGELESS	W WALL WASH	-827 80 CRI, 2700K, 2-STEP	-Z ANTIQUE BRONZE
E3S ELEMENT 3" SQUARE	F FLANGED		-830 80 CRI, 3000K, 2-STEP	-B BLACK
	F15 FLANGED 1.1"-1.5" CEILING THICKNESS ¹		-835 80 CRI, 3500K, 2-STEP	-S SATIN NICKEL
	F20 FLANGED 1.6"-2.0" CEILING THICKNESS ¹		-927 90 CRI, 2700K, 2-STEP	-W WHITE
	F25 FLANGED 2.1"-2.5" CEILING THICKNESS ¹		-930 90 CRI, 3000K, 2-STEP	
			-935 90 CRI, 3500K, 2-STEP	
			-WD 90 CRI, 3000-1800K, WARM DIM, 3-STEP	
			-TW52 90 CRI, 5000K-2700K, TUNABLE WHITE, 2-STEP ²	
		W	-	-

¹F15/F20/F25 - Compatible with square wall wash trims only. Round wall wash flanged trims accommodate up to 1" max ceiling thickness.

²TW52 - Tunable white only available in high output, only available with ELTO (0-10V, linear), or ELTD (DALI-2). For 0-10V logarithmic dimming or for 4000K - 1800K option, consult Quotes Department.

PLASTER PLATES

PRODUCT	
150E3RPPLT-A	3" PLASTER PLATE ROUND DIE-CAST METAL ¹
150E3SPPLT-A	3" PLASTER PLATE SQUARE DIE-CAST METAL ¹
150E3RTPPLT-W	3" PLASTER PLATE ROUND SHEET METAL ²
150E3STPPLT-W	3" PLASTER PLATE SQUARE SHEET METAL ²

Plaster plates are used to convert flanged housings into flangeless housings.

¹Ships standard with flangeless housings. Round not compatible with Lutron Hi-lume or eldoLED drivers.

²Optional, thinner, meshed sheet-metal mud plates available for minimized plaster feathering to meet installer preference. Round not compatible with Lutron Hi-lume or eldoLED drivers. Square not compatible with eldoLED drivers.

ELEMENT™ 3" LED

WALL WASH

TRIMS

FLANGED



ROUND WALL WASH

FLANGELESS



ROUND WALL WASH

FLANGELESS IN WOOD CEILING



ROUND (ANTIQUE BRONZE)

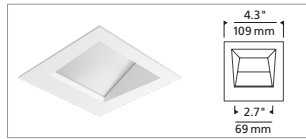

SQUARE WALL WASH

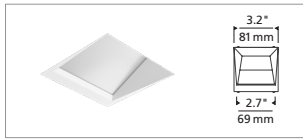

SQUARE WALL WASH



SQUARE (SATIN NICKEL)

FINISH



ANTIQUE BRONZE



BLACK



SATIN NICKEL



WHITE (PAINTABLE)

WARM DIM CURVE

CCT vs. Forward Current, $T_c=25^\circ\text{C}$

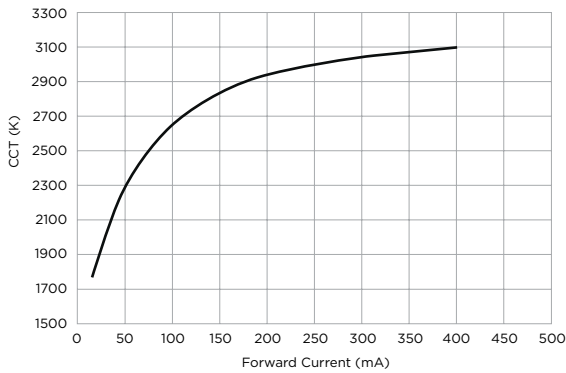

HOUSING

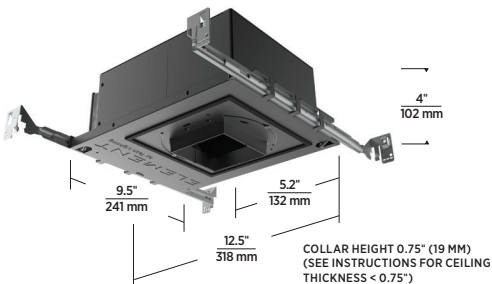

IC AIRTIGHT / CHICAGO PLENUM

ELEMENT™ 3" LED WALL WASH

The ELEMENT 3" Wall Wash provide a best-in-class solution for a smooth and consistent flood of light vertically and horizontally to illuminate a large surface area and highlight multiple focal points, texture and design without compromise. Refer to the charts and visuals below for performance guidance to help determine fixture space and ensure your lighting design meets your needs.

PERFORMANCE

- Delivered Lumens: 1,340
- High Efficacy: 79 Lumens per Watt
- Reduced shadowing near ceiling
- Low ratio between highest and lowest foot-candles prevents hot spots

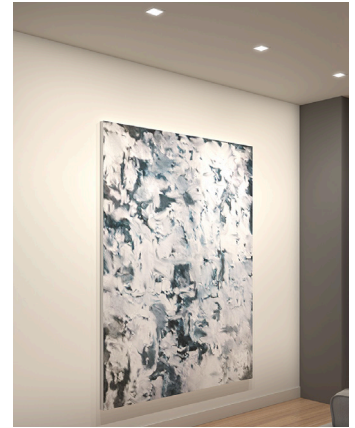
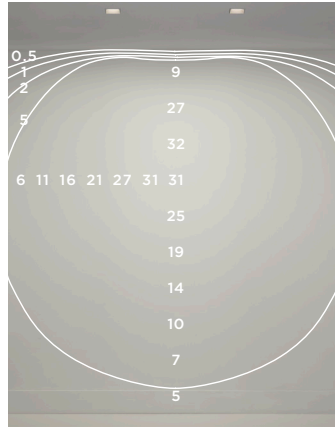

2.5' FROM WALL

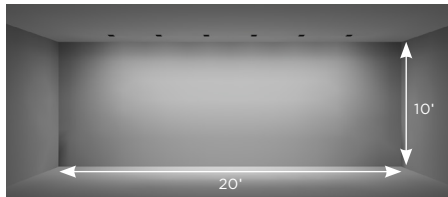

2.5' ON CENTER, 6 FIXTURES

3' FROM WALL

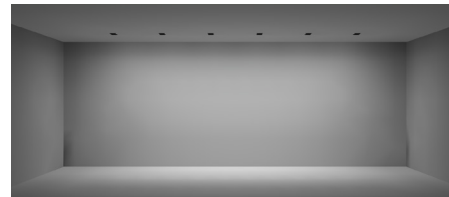

2.5' ON CENTER, 6 FIXTURES

3.5' FROM WALL

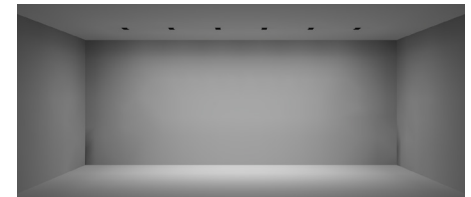

2.5' ON CENTER, 6 FIXTURES



3' ON CENTER, 6 FIXTURES

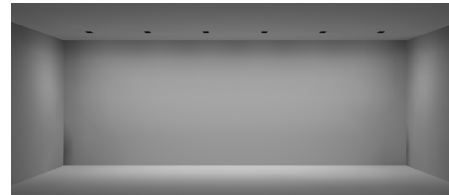

3' ON CENTER, 6 FIXTURES



3' ON CENTER, 6 FIXTURES



3.5' ON CENTER, 4 FIXTURES

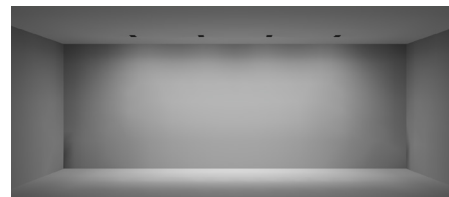

3.5' ON CENTER, 4 FIXTURES

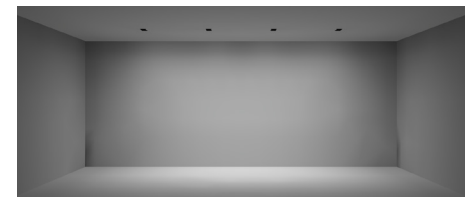

3.5' ON CENTER, 4 FIXTURES

FOOT-CANDLES ON WALL FROM MULTIPLE FIXTURES

HEIGHT ON WALL	2.5' FROM WALL								
	←2.5' on center		←3' on center		←3.5' on center				
9.5'	4.7	3.7	4.7	4.6	3.0	4.6	4.4	2.3	4.4
9'	15.2	14.0	15.2	14.6	11.5	14.6	14.1	9.3	14.1
8'	26.5	29.7	26.5	24.7	25.7	24.7	23.4	21.9	23.4
7'	28.9	32.8	28.9	26.6	29.7	26.6	24.7	26.5	24.7
6'	27.0	30.1	27.0	25.0	27.9	25.0	23.0	25.5	23.0
5'	21.5	23.7	21.5	20.1	22.3	20.1	18.6	20.9	18.6
4'	16.1	17.4	16.1	15.2	16.6	15.2	14.2	15.8	14.2
3'	11.7	12.5	11.7	11.2	12.1	11.2	10.6	11.6	10.6
2'	8.5	9.0	8.5	8.2	8.8	8.2	7.8	8.5	7.8
1'	6.3	6.6	6.3	6.0	6.4	6.0	5.8	6.3	5.8
0.5'	4.7	4.9	4.7	4.6	4.8	4.6	4.4	4.7	4.4

HEIGHT ON WALL	3' FROM WALL								
	←2.5' on center		←3' on center		←3.5' on center				
9.5'	2.7	2.4	2.7	2.6	2.0	2.6	2.5	1.7	2.5
9'	9.5	9.3	9.5	9.0	8.0	9.0	8.6	6.7	8.6
8'	18.7	21.1	18.7	17.5	18.6	17.5	16.4	16.3	16.4
7'	21.2	23.8	21.2	19.6	22.0	19.6	18.1	20.1	18.1
6'	21.9	24.3	21.9	20.4	22.7	20.4	18.8	21.0	18.8
5'	19.5	21.2	19.5	18.3	20.1	18.3	17.0	18.9	17.0
4'	15.8	16.9	15.8	14.9	16.2	14.9	14.0	15.5	14.0
3'	12.2	13.0	12.2	11.7	12.6	11.7	11.1	12.1	11.1
2'	9.4	9.9	9.4	9.0	9.6	9.0	8.6	9.3	8.6
1'	7.1	7.5	7.1	6.9	7.3	6.9	6.6	7.1	6.6
0.5'	5.4	5.6	5.4	5.3	5.5	5.3	5.1	5.4	5.1

HEIGHT ON WALL	3.5' FROM WALL								
	←2.5' on center		←3' on center		←3.5' on center				
9.5'	1.7	1.6	1.7	1.6	1.4	1.6	1.6	1.2	1.6
9'	6.4	6.5	6.4	6.0	5.7	6.0	5.7	4.9	5.7
8'	13.5	15.2	13.5	12.6	13.7	12.6	11.8	12.2	11.8
7'	16.3	18.2	16.3	15.2	17.0	15.2	14.0	15.7	14.0
6'	17.2	18.9	17.2	16.1	17.7	16.1	14.9	16.7	14.9
5'	16.6	18.0	16.6	15.7	17.1	15.7	14.7	16.2	14.7
4'	14.5	15.5	14.5	13.9	14.9	13.9	13.0	14.3	13.0
3'	12.0	12.7	12.0	11.5	12.3	11.5	10.9	11.8	10.9
2'	9.6	10.1	9.6	9.3	9.8	9.3	8.8	9.5	8.8
1'	7.6	7.9	7.6	7.4	7.7	7.4	7.1	7.5	7.1
0.5'	6.0	6.2	6.0	5.8	6.1	5.8	5.6	5.9	5.6

ELEMENT™ 3" LED

WALL WASH

PLASTER PLATES

INCLUDED DIE-CAST

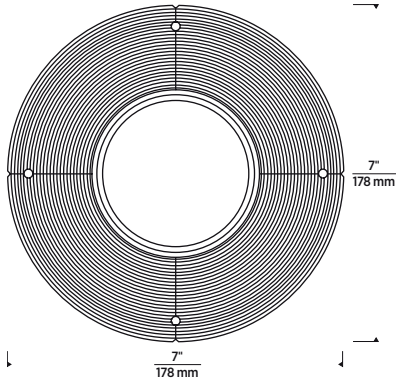

ROUND DIE-CAST (INCLUDED FOR FLANGELESS INSTALLATION)

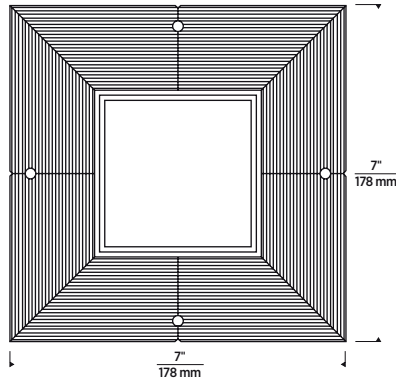

SQUARE DIE-CAST (INCLUDED FOR FLANGELESS INSTALLATION)

OPTIONAL SHEET METAL

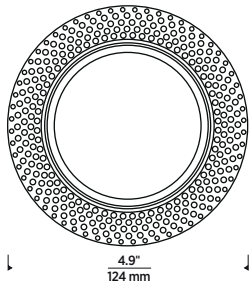

ROUND SHEET METAL (OPTIONAL FOR FLANGELESS INSTALLATION)

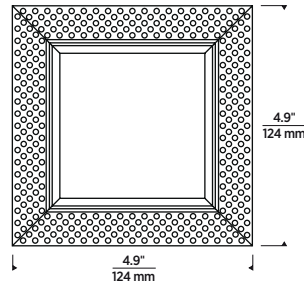

SQUARE SHEET METAL (OPTIONAL FOR FLANGELESS INSTALLATION)

FLANGELESS IN WOOD CEILING TRIM ADAPTER

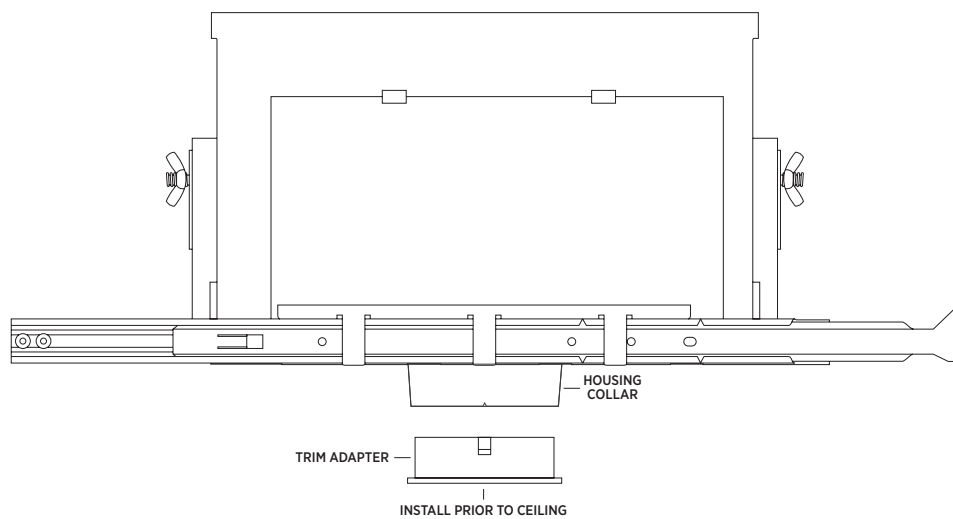

TRIM ADAPTER INSTALLED

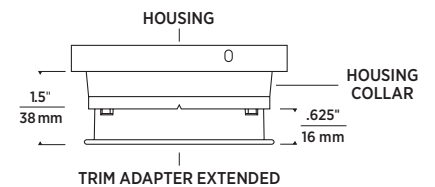
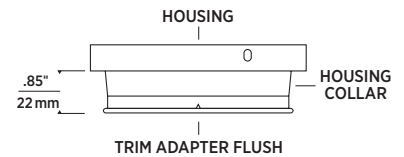

Wood ceiling housings ("WC" designation in the ordering grid) ship with an adjustable trim adapter that inserts into the housing aperture and allows standard ELEMENT 3" flangeless trims to achieve a truly flangeless, flush ceiling appearance in special applications such as wood or stone installation. For use in new construction. Consult installation instructions regarding plenum requirements and ceiling thickness ratios.

ELEMENT™ 3" LED

WALL WASH

PHOTOMETRICS

Description: 3" LED Wall Wash
80 CRI, 3000K

Model: E3 Citizen LED -
High Output

Input Power (Watts): 17.4

Input Power Factor: 0.98

Absolute Luminous
Flux (Lumens): 1342

Lumen Efficacy
(Lumens per Watt): 77

Output difference between CCTs - 5%, CRIs - 15%.

Description: 3" LED Wall Wash
90 CRI, 3000K

Model: E3 Citizen LED -
Low Output

Input Power (Watts): 18

Input Power Factor: 0.98

Absolute Luminous
Flux (Lumens): 924

Lumen Efficacy
(Lumens per Watt): 51.2

ANGLE	0°	45°	90°
0°	750	750	750
5°	886	839	740
10°	1002	913	722
15°	1044	968	693
20°	1024	971	654
25°	921	918	603
30°	784	836	539
35°	632	712	460
40°	490	580	362
45°	368	452	262
50°	290	344	186
55°	239	252	140
60°	195	185	107
65°	154	131	77
70°	117	88	51
75°	83	56	29
80°	53	30	13
85°	23	11	4
90°	0	0	0

ANGLE	0°	45°	90°
0°	600	600	600
5°	755	688	580
10°	878	752	545
15°	963	779	492
20°	997	766	427
25°	970	714	358
30°	887	630	288
35°	751	529	218
40°	580	419	155
45°	406	311	109
50°	259	215	77
55°	152	136	53
60°	80	79	35
65°	36	42	21
70°	15	18	13
75°	7	7	8
80°	4	4	5
85°	1	1	2
90°	0	0	0

