

# ELEMENT™ 4" LED

## ADJUSTABLE DOWNLIGHT

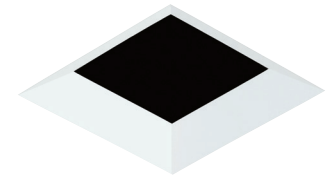

SHOWN IN FLANGELESS BEVEL SQUARE

The ELEMENT 4" Next Generation Adjustable recessed downlight features full adjustability with lockable, tool-free, hot aiming. ELEMENT's patented high/low lamp positioning allows the LED to be positioned closer to the aperture for maximum light output and efficiency or higher in the ceiling to minimize glare and flash on the trim. Options include premium warm dimming, Tunable White, Xicato and Xicato Artist Series LED modules. Trim options include flanged or flangeless and flangeless wood ceiling.

- Housing reduced by 54%
- Tool-free, aiming/locking: 0-40° tilt, 361° rotation
- Patented high/low lamp positioning
- 2-step standard
- Standard dimming (down to 1%)
- Trim reflector options
- Solite Soft Focus lens option

### LUMEN MULTIPLIER (CRI/CCT)

| CCT   | 80 CRI MULTIPLIER | 90 CRI MULTIPLIER |
|-------|-------------------|-------------------|
| 2700K | 0.95              | 0.80              |
| 3000K | 1.00              | 0.85              |
| 3500K | 1.05              | 0.90              |

Lumen output will vary by CCT and CRI. See photometric charts for output information.

### SPECIFICATIONS

|                             | STATIC WHITE   |             |            | XICATO  |   | WARM DIM  |            | TUNABLE WHITE                          |                     |
|-----------------------------|--|-------------|------------|---|---|---|------------|--|---------------------|
|                             | MAX OUTPUT   | HIGH OUTPUT | LOW OUTPUT | STANDARD SERIES                                 | ARTIST SERIES                             | HIGH OUTPUT                                     | LOW OUTPUT | HIGH OUTPUT (5000K)                    | HIGH OUTPUT (4000K) |
| <b>DELIVERED LUMENS</b>     | 4000/3400  | 2900/2465   | 1800/1450  | 1575  | 1856                                      | 2374  | 1300       | 2157                                   | 1900                |
| <b>WATTS</b>                | 35   | 29          | 17         | 19  | 26  | 31  | 17         | 28                                     | 28                  |
| <b>EFFICACY</b>             | 112/96   | 100/85      | 106/85     | 81  | 71  | 76  | 76         | 72                                     | 69                  |
| <b>CRI</b>                  | 80+/90+  |             |            | 80+   | 95+                                       | 90+   |            |  |                     |
| <b>CBCP</b>                 | 10° - 19,414 (low output)   18° - 8,192<br>25° - 6,907   40° - 4,517   60° - 3,209   |             |            | 21° - 8,345<br>43° - 3,644<br>60° - 1,964       | 21° - 8,471<br>43° - 4,022<br>60° - 2,237 | 18° - N/A   25° - N/A   40° - 2,381   60° - N/A |            |  |                     |
| <b>CCT</b>                  | 2700K, 3000K, or 3500K   |             |            | 2700K, 3000K, or 3500K <sup>3</sup>             |   | 3000K - 1800K                                   |            | 5000K - 2700K                          | 4000K - 1800K       |
| <b>COLOR CONSISTENCY</b>    | 2-step   |             |            | 1 X 2-step                                      |   | 3-step  |            | 2-step                                 |                     |
| <b>VOLTAGE</b>              | 120V or 277V   |             |            |   |   |   |            |  |                     |
| <b>DIMMING<sup>1</sup></b>  | Standard reverse-phase, forward-phase, TRIAC, and 0-10V dimming (down to 1%)<br>eldoLED 0-10V or DALI-2 (down to 0.1%)<br>Lutron Hi-lume EcoSystem (down to 0.1%)  |             |            |   |   |   |            | eldoLED 0-10V or DALI-2 (down to 0.1%) |                     |
| <b>POWER SUPPLY</b>         | Constant current driver with +.9 power factor and +80% efficiency  |             |            |   |   |   |            |  |                     |
| <b>OPTICS</b>               | Field changeable:<br>10°, 18°, 25°, 40°, or 60° TIR  |             |            | Field changeable:<br>21°, 43°, or 60° Reflector |   | Field changeable:<br>18°, 25°, 40°, or 60° TIR  |            |  |                     |
| <b>ADJUSTABILITY</b>        | Lockable, hot-aiming, 0-40° tilt, 361° rotation, high/low positioning, 45° collar rotation   |             |            |   |   |   |            |  |                     |
| <b>CEILING APPEARANCE</b>   | Flanged, flangeless, or flangeless in wood ceiling   |             |            |   |   |   |            |  |                     |
| <b>CEILING THICKNESS</b>    | Flanged: Up to 2-1/2"<br>Flangeless: No ceiling thickness limitations   Flangeless in Wood Ceiling: 1/2" to 2"<br>Note: Thicker ceilings impact light cutoff   |             |            |   |   |   |            |  |                     |
| <b>CEILING APERTURE</b>     | 4-1/2" ceiling cutout  |             |            |   |   |   |            |  |                     |
| <b>HOUSING</b>              | IC Airtight, Non-IC Airtight, Chicago Plenum. IC suitable up to R60 spray foam insulation.<br>Sauna/steam-room use available only with combination of H shower trim, LO low output housing, and I IC housing rating. |             |            |   |   |   |            |  |                     |
| <b>CONSTRUCTION</b>         | Housing: Heavy-gauge, Cold-rolled steel   Trim: Die-cast aluminum  |             |            |   |   |   |            |  |                     |
| <b>FINISH</b>               | Housing: Black Powder Coat   Trim: Antique Bronze, Black, Satin Nickel, or White (paintable)   |             |            |   |   |   |            |  |                     |
| <b>GENERAL LISTINGS</b>     | ETL Listed. Damp Location. Shower version Wet Listed.  |             |            |   |   |   |            |  |                     |
| <b>CALIFORNIA TITLE 24</b>  | Registered CEC Appliance Database. Can be used to comply with CEC 2019 Title 24 Part 6 (JA8-2016, JA8-2019) (for 90 CRI versions).   |             |            |   |   |   |            |  |                     |
| <b>L70</b>                  | 50,000 hours min   |             |            |   |   |   |            |  |                     |
| <b>WARRANTY<sup>2</sup></b> | 5 years  |             |            |   |   |   |            |  |                     |

Data in chart reflect 3000K/80 CRI values unless noted.

Custom output/custom RAL/custom CCT available, contact Quotes Department

**Ordering grids available on page 2.**

Accepts two optical controls and an optional trim-mounted lens.

<sup>1</sup>See visualcomfort.com for dimmer compatibility. LH high output and LV max output standard phase dimming down to 5% min.

<sup>2</sup>Visit visualcomfort.com for specific warranty limitations and details.

<sup>3</sup>3500K Xicato module not available for Artist series.

# ELEMENT™ 4" LED

## ADJUSTABLE DOWNLIGHT

### ORDERING GRIDS

#### HOUSING

| PRODUCT                      | CEILING APPEARANCE                      | OUTPUT  | CRI/CCT  | BEAM SPREAD  | FUNCTION            | HOUSING RATING  | DRIVER   | VOLTAGE  |
|------------------------------|---|---|--|--|---------------------|---|--|--|
| <b>E4R</b> ELEMENT 4" ROUND  | <b>L</b> FLANGELESS<br><b>F</b> FLANGED | <b>-LV</b> MAX OUTPUT, 35W <sup>2</sup>   | <b>827</b> 80 CRI, 2700K, 2-STEP<br><b>830</b> 80 CRI, 3000K, 2-STEP   | <b>10</b> 10° <sup>6</sup><br><b>18</b> 18°                          | <b>A</b> ADJUSTABLE | <b>I</b> IC AIRTIGHT<br><b>N</b> NON-IC AIRTIGHT                                | <b>INTEGRATED DRIVERS 120V/277V</b><br>UNIVERSAL PHASE/0-10V 1% (LEAVE BLANK) <sup>7</sup>   | 120 VOLT (LEAVE BLANK)<br><b>-277</b> 277 VOLT |
| <b>E4S</b> ELEMENT 4" SQUARE | <b>WC</b> WOOD CEILING <sup>1</sup>     | <b>-LH</b> HIGH OUTPUT, 29W <sup>3</sup><br><b>-LO</b> LOW OUTPUT, 17W <sup>4</sup> | <b>835</b> 80 CRI, 3500K, 2-STEP<br><b>927</b> 90 CRI, 2700K, 2-STEP<br><b>930</b> 90 CRI, 3000K, 2-STEP<br><b>935</b> 90 CRI, 3500K, 2-STEP<br><b>WD</b> 90 CRI, 3000-1800K, WARM DIM, 3-STEP<br><b>TW52</b> 90 CRI, 5000K-2700K, TUNABLE WHITE, 2-STEP <sup>5</sup><br><b>TW41</b> 90 CRI, 4000K-1800K, TUNABLE WHITE, 2-STEP <sup>5</sup> | <b>25</b> 25°<br><b>40</b> 40°<br><b>60</b> 60°                      |                     | <b>C</b> CHICAGO PLENUM<br><b>E</b> EMERGENCY BATTERY (NON-IC / CHICAGO PLENUM) | <b>-ELDO</b> ELDOLED 0.1% 0-10V LINEAR<br><b>-ELDOA</b> ELDOLED 0.1% 0-10V LOGARITHMIC<br><b>-ELDD</b> ELDOLED 0.1% DALI-2<br><b>-ELTO</b> ELDOLED TUNABLE WHITE 0.1% 0-10V LINEAR <sup>5</sup><br><b>-ELTD</b> ELDOLED TUNABLE WHITE 0.1% DALI-2 <sup>5</sup><br><b>-HLECO</b> LUTRON HI-LUME 0.1% ECOSYSTEM <sup>8</sup> |  |
|                              |   | <b>-X</b> XICATO, HIGH OUTPUT, 25W <sup>9</sup>                                     | <b>I27</b> 80 CRI, 2700K, 1X2-STEP, XICATO<br><b>I30</b> 80 CRI, 3000K, 1X2-STEP, XICATO<br><b>I35</b> 80 CRI, 3500K, 1X2-STEP, XICATO<br><b>A27</b> 95 CRI, 2700K, 1X2-STEP, XICATO ARTIST<br><b>A30</b> 95 CRI, 3000K, 1X2-STEP, XICATO ARTIST   | <b>21</b> 21° XICATO<br><b>43</b> 43° XICATO<br><b>60</b> 60° XICATO |                     |   |  |  |

Trims are required and must be ordered separately.

<sup>1</sup>WC - Wood ceiling option accommodates flangeless trims only.

<sup>2</sup>LV - Max output not available in I IC housing with HLECO Lutron driver, WD warm dim or TW tunable white. Standard phase dimming down to 5% min. LV available for wet application (not rated for sauna/steam-room).

<sup>3</sup>LH - Standard phase dimming down to 5% min. LH available for wet application (not rated for sauna/steam-room).

<sup>4</sup>LO - Sauna/steam-room use available only with combination of H shower trim, LO low output and I IC housing.

<sup>5</sup>TW52, TW41 - Tunable white only available in LH high output, only available with ELTO (0-10V, linear), or ELTD (DALI-2). I IC housing output is 15% less than N non-IC housing output.

For 0-10V logarithmic dimming consult Quotes Department.

<sup>6</sup>10 - Available LO low output only. 10° beam spread has a unique LED module not available with warm dim or tunable white. Changing optics to 18°, 25°, 40°, or 60° will require a new LED module.

<sup>7</sup>Universal dimming is reverse-phase, forward-phase, TRIAC, and 0-10V. 277V is only compatible with 0-10V dimming.

<sup>8</sup>HLECO - Lutron EcoSystem available IC only for L08, L12, and L17 output. Available with WD31 warm dim only for L12 and L17 output. Not available for L36 output.

<sup>9</sup>X - Xicato housings utilize dedicated standard phase, 0-10V, 120V and 277V drivers. If ordering Xicato with standard drivers (non-Lutron or eldoLED), at the end of the item number please specify:

**-010** for 0-10V 120V, **-277** for phase 277V or **-010-277** for 0-10V 277. For example: E3RLF-XA2743DI-**010** or E3RLF-XA2743DI-**277** or E3RLF-XA2743DI-**010-277**. Due to the size of some of the Xicato Reflectors, it may not be feasible to tilt the fixture in the 'low' position. It is still tiltable in the 'high' position.

#### TRIM

| PRODUCT                      | CEILING APPEARANCE                             | STYLE          | APERTURE   | FINISH  |
|------------------------------|--|----------------|--|---|
| <b>E4R</b> ELEMENT 4" ROUND  | <b>L</b> FLANGELESS                            | <b>B</b> BEVEL | <b>-O</b> NO LENSE   | <b>Z</b> ANTIQUE BRONZE                                   |
| <b>E4S</b> ELEMENT 4" SQUARE | <b>F</b> FLANGED                               | <b>F</b> FLAT  | <b>-H</b> SHOWER <sup>1,2</sup><br><b>-L</b> LENSED <sup>2</sup> | <b>B</b> BLACK<br><b>S</b> SATIN NICKEL<br><b>W</b> WHITE |
|                              | <b>F15</b> FLANGED 1.1"-1.5" CEILING THICKNESS |                |  |   |
|                              | <b>F20</b> FLANGED 1.6"-2.0" CEILING THICKNESS |                |  |   |
|                              | <b>F25</b> FLANGED 2.1"-2.5" CEILING THICKNESS |                |  |   |

<sup>1</sup>H - Sauna/steam-room use available only with combination of H shower trim, LO low output and I IC housing.

<sup>2</sup>H, L - Lensed products come with Solite Soft Focus lens.

#### LENSES / LOUVERS<sup>1</sup>

| PRODUCT          |                         |
|------------------|-------------------------|
| <b>140MR16SF</b> | SOLITE SOFT FOCUS LENS  |
| <b>140MR16SB</b> | SANDBLASTED LENS        |
| <b>140MR16LL</b> | LINEAR SPREAD LENS      |
| <b>140MR16DF</b> | DIFFUSER SPREAD LENS    |
| <b>EL2RHCBK</b>  | EGGCRATE/HEXCELL LOUVER |

<sup>1</sup>For additional lenses, louvers, optical controls and accessories, reference visualcomfort.com. ELEMENT allows up to two lenses or louvers per fixture.

#### PLASTER PLATES

| PRODUCT           |                      |
|-------------------|----------------------|
| <b>150E4RPPLT</b> | ROUND PLASTER PLATE  |
| <b>150E4SPPLT</b> | SQUARE PLASTER PLATE |

Plaster plates are used to convert flanged housings into flangeless housings. Ships standard with flangeless housings.

#### REPLACEMENT OPTICS

| PRODUCT             | BEAM SPREAD  |
|---------------------|--|
| <b>353E4LEDCOPT</b> | <b>18</b> 18°<br><b>25</b> 25°<br><b>40</b> 40°<br><b>60</b> 60° |

#### 353E4LEDCOPT

#### REPLACEMENT REFLECTORS<sup>1</sup>

| PRODUCT           | BEAM SPREAD                                     |
|-------------------|---|
| <b>352LEDXREF</b> | <b>21</b> 21°<br><b>43</b> 43°<br><b>60</b> 60° |

#### 352LEDXREF

<sup>1</sup>For use with Xicato modules only.

#### PREMIUM LENS HOLDER

| PRODUCT              | LENSES                                   |
|----------------------|--|
| <b>240E3LENSHLDR</b> | <b>1</b> ONE LENS<br><b>2</b> TWO LENSES |

#### 240E3LENSHLDR

The premium, threaded lens holder provides more secure mounting of additional lenses as compared to the standard lens holder that ships with each fixture. Premium Lens Holder is not compatible with the 10° beam spread.



# ELEMENT™ 4" LED

## ADJUSTABLE DOWNLIGHT

### TRIMS

#### FLANGED

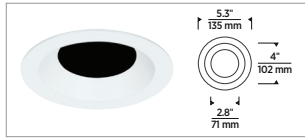

ROUND BEVEL

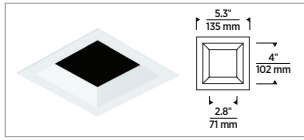

SQUARE BEVEL

#### FLANGELESS

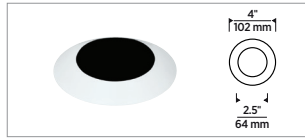

ROUND FLANGELESS

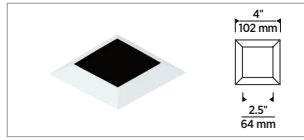

SQUARE FLANGELESS

#### FINISH

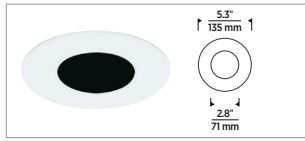

ROUND FLAT

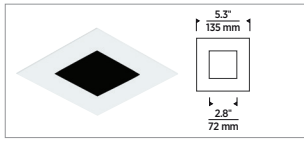

SQUARE FLAT

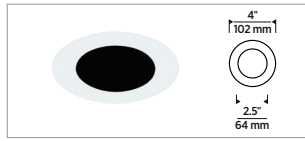

ROUND FLANGELESS

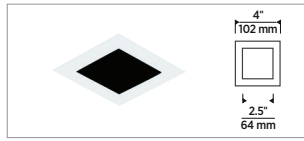

SQUARE FLANGELESS

#### FLANGELESS IN WOOD CEILING



ROUND BEVEL (ANTIQUE BRONZE)

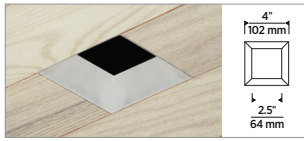

SQUARE BEVEL (SATIN NICKEL)



ROUND FLAT (ANTIQUE BRONZE)

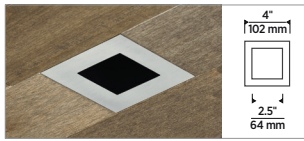

SQUARE FLAT (SATIN NICKEL)

#### LENS OPTION

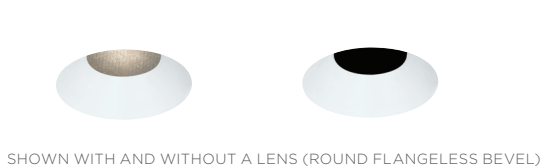
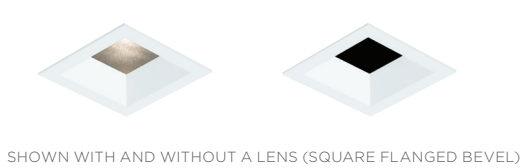

See installation instruction sheet on [www.techlighting.com](http://www.techlighting.com).

#### WARM DIM CURVE

CCT vs. Forward Current,  $T_c=25^\circ\text{C}$

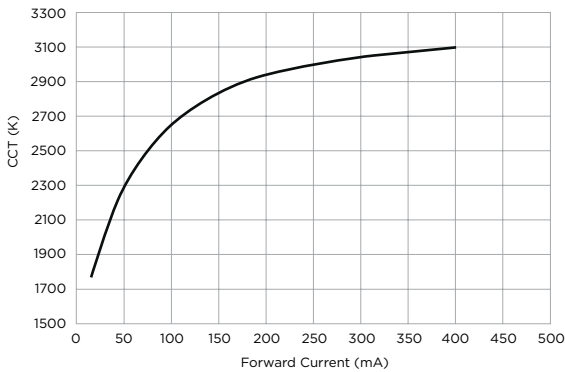

# ELEMENT™ 4" LED

## ADJUSTABLE DOWNLIGHT

### HOUSING

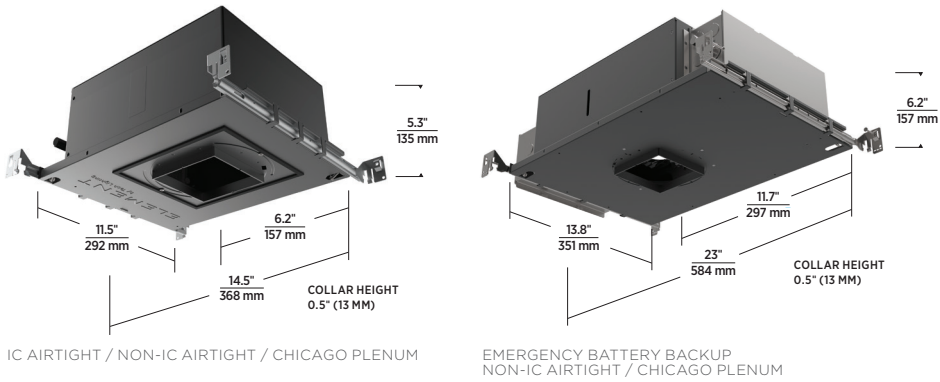

IC AIRTIGHT / NON-IC AIRTIGHT / CHICAGO PLENUM

EMERGENCY BATTERY BACKUP  
 NON-IC AIRTIGHT / CHICAGO PLENUM

### PLASTER PLATES

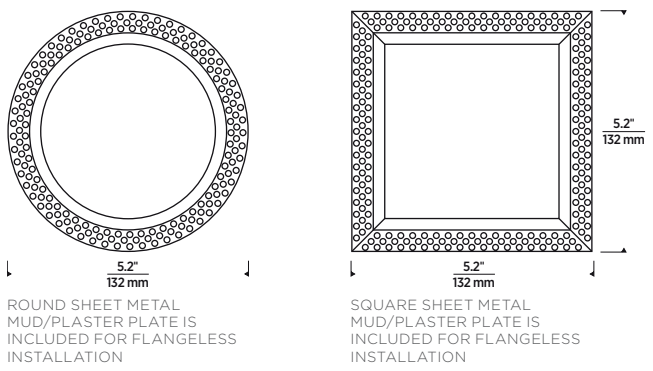

ROUND SHEET METAL  
 MUD/PLASTER PLATE IS  
 INCLUDED FOR FLANGELESS  
 INSTALLATION

SQUARE SHEET METAL  
 MUD/PLASTER PLATE IS  
 INCLUDED FOR FLANGELESS  
 INSTALLATION

### FLANGELESS IN WOOD CEILING INSTALLATION

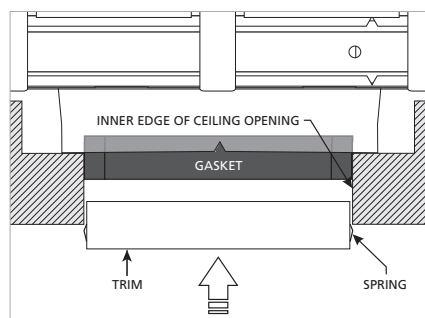

# ELEMENT™ 4" LED ADJUSTABLE DOWNLIGHT

## TRIM-MOUNTED REFLECTORS

ELEMENT Specular Reflectors reduce glare while creating a clean, quiet ceiling appearance. These beautiful trim accessories have been specifically designed to minimize any effect on light performance, color and output. Specular Reflectors are available for both adjustable and fixed downlights, and are compatible with ELEMENT 4" trims and housings.

- Can be easily installed or removed
- Mounts to existing trim
- Compatible with fixed and adjustable housings



BELOW CEILING VIEW

















SHOWN MOUNTED TO TRIM



REFLECTOR ONLY

## SPECIFICATIONS

| COMPATIBLE TRIMS  | NON-SLOTTED<br>(FOR FIXED <sup>1</sup> )  | SLOTTED<br>(FOR ADJUSTABLE)  |
|---|---|--|
|  4" round, flanged, bevel    |  <b>E4TREFNS2B</b>   |  <b>E4TREFS5B</b>   |
|  4" round, flanged, flat     |  <b>E4TREFNS1B</b>   |  <b>E4TREFS3B</b>   |
|  4" round, flangeless, bevel |  <b>E4TREFNS2B</b>   |  <b>E4TREFS5B</b>   |
|  4" round, flangeless, flat |  <b>E4TREFNS1B</b>  |  <b>E4TREFS3B</b>  |
|  4" square, flanged, bevel |  <b>E4TREFNS6B</b> |  <b>E4TREFS2B</b> |

Only compatible with ELEMENT 4" LED series.

May require lamp to be placed in high position.

Not available for ELEMENT 4" square flat trims or square flangeless bevel trims.

Not compatible with lensed trims.

<sup>1</sup>Non-slotted reflectors may be used in adjustable housings with the lamp assembly placed in the 0° tilt position.

## ORDERING GRID

### E4 TRIM MOUNTED REFLECTORS<sup>1</sup>

| PRODUCT       | STYLE                  | FINISH                  |
|---------------|------------------------|-------------------------|
| <b>E4TREF</b> | <b>NS1</b> NON-SLOTTED | <b>B</b> ANODIZED BLACK |
|               | <b>NS2</b> NON-SLOTTED |                         |
|               | <b>NS6</b> NON-SLOTTED |                         |
|               | <b>S2</b> SLOTTED      |                         |
|               | <b>S3</b> SLOTTED      |                         |
|               | <b>S5</b> SLOTTED      |                         |

**E4TREF** **B**

<sup>1</sup>Not compatible with lensed trims.

# ELEMENT™ 4" LED

## ADJUSTABLE DOWNLIGHT

### PHOTOMETRICS

Description: 4" LED Module  
18° Beam - 0° Tilt,  
90 CRI, 3000K

Model: E4 LED

Input Power (Watts): 32.9

Input Power Factor: 0.99

Absolute Luminous Flux (Lumens): 2494

Lumen Efficacy (Lumens per Watt): 76

Description: 4" LED Module  
25° Beam - 0° Tilt,  
90 CRI, 3000K

Model: E4 LED

Input Power (Watts): 32.7

Input Power Factor: 0.98

Absolute Luminous Flux (Lumens): 2456

Lumen Efficacy (Lumens per Watt): 75

Description: 4" LED Module  
40° Beam - 0° Tilt,  
90 CRI, 3000K

Model: E4 LED

Input Power (Watts): 32.8

Input Power Factor: 0.98

Absolute Luminous Flux (Lumens): 2584

Lumen Efficacy (Lumens per Watt): 79

Output difference between CCTs - 5%, CRIs - 15%.

| ANGLE | 0°   | 45°  | 90°  |
|-------|------|------|------|
| 0°    | 8192 | 8192 | 8192 |
| 5°    | 7438 | 7514 | 7532 |
| 10°   | 5277 | 5300 | 5297 |
| 15°   | 3190 | 3214 | 3209 |
| 20°   | 1898 | 1908 | 1900 |
| 25°   | 1066 | 1077 | 1064 |
| 30°   | 610  | 626  | 608  |
| 35°   | 319  | 386  | 325  |
| 40°   | 161  | 249  | 162  |
| 45°   | 94   | 145  | 94   |
| 50°   | 62   | 77   | 63   |
| 55°   | 37   | 49   | 37   |
| 60°   | 25   | 30   | 25   |
| 65°   | 12   | 16   | 13   |
| 70°   | 1    | 7    | 2    |
| 75°   | 0    | 0    | 0    |
| 80°   | 0    | 0    | 0    |
| 85°   | 0    | 0    | 0    |
| 90°   | 0    | 0    | 0    |

| ANGLE | 0°   | 45°  | 90°  |
|-------|------|------|------|
| 0°    | 6907 | 6907 | 6907 |
| 5°    | 6578 | 6568 | 6565 |
| 10°   | 5455 | 5476 | 5467 |
| 15°   | 3575 | 3584 | 3595 |
| 20°   | 1856 | 1910 | 1947 |
| 25°   | 997  | 1040 | 1057 |
| 30°   | 623  | 654  | 660  |
| 35°   | 330  | 433  | 358  |
| 40°   | 153  | 276  | 165  |
| 45°   | 88   | 149  | 96   |
| 50°   | 57   | 73   | 61   |
| 55°   | 32   | 44   | 35   |
| 60°   | 19   | 25   | 21   |
| 65°   | 8    | 12   | 9    |
| 70°   | 0    | 4    | 1    |
| 75°   | 0    | 0    | 0    |
| 80°   | 0    | 0    | 0    |
| 85°   | 0    | 0    | 0    |
| 90°   | 0    | 0    | 0    |

| ANGLE | 0°   | 45°  | 90°  |
|-------|------|------|------|
| 0°    | 4517 | 4517 | 4517 |
| 5°    | 4385 | 4393 | 4402 |
| 10°   | 4053 | 4071 | 4076 |
| 15°   | 3498 | 3518 | 3534 |
| 20°   | 2595 | 2648 | 2698 |
| 25°   | 1635 | 1620 | 1598 |
| 30°   | 860  | 850  | 804  |
| 35°   | 374  | 429  | 396  |
| 40°   | 179  | 224  | 190  |
| 45°   | 101  | 123  | 107  |
| 50°   | 60   | 75   | 64   |
| 55°   | 31   | 47   | 32   |
| 60°   | 19   | 26   | 20   |
| 65°   | 7    | 12   | 8    |
| 70°   | 1    | 3    | 1    |
| 75°   | 0    | 0    | 0    |
| 80°   | 0    | 0    | 0    |
| 85°   | 0    | 0    | 0    |
| 90°   | 0    | 0    | 0    |

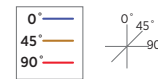
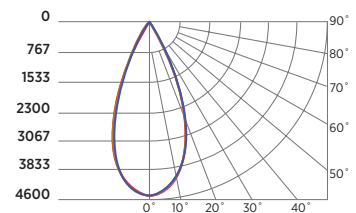
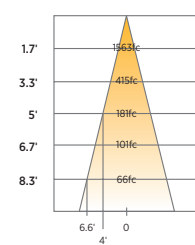
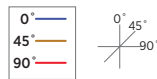
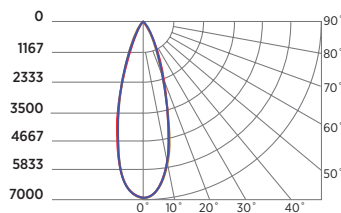
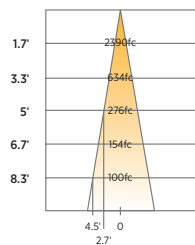
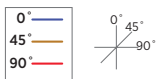
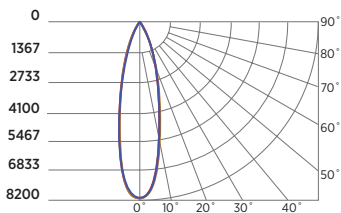
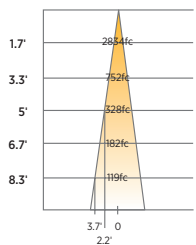

# ELEMENT™ 4" LED

## ADJUSTABLE DOWNLIGHT

### PHOTOMETRICS

Description: 4" LED Module  
 60° Beam - 0° Tilt,  
 80 CRI, 3000K

Model: E4 LED

Input Power (Watts): 30.7

Input Power Factor: 0.98

Absolute Luminous

Flux (Lumens): 3178

Lumen Efficacy

(Lumens per Watt): 103.4

Output difference between CCTs - 5%, CRIs - 15%.

| ANGLE | 0°   | 45°  | 90°  |
|-------|------|------|------|
| 0°    | 3209 | 3209 | 3209 |
| 5°    | 3215 | 3152 | 3158 |
| 10°   | 3103 | 3067 | 3068 |
| 15°   | 2869 | 2852 | 2881 |
| 20°   | 2428 | 2393 | 2468 |
| 25°   | 1881 | 1814 | 1930 |
| 30°   | 1398 | 1324 | 1441 |
| 35°   | 982  | 939  | 1038 |
| 40°   | 597  | 603  | 681  |
| 45°   | 334  | 359  | 393  |
| 50°   | 186  | 202  | 210  |
| 55°   | 89   | 118  | 98   |
| 60°   | 46   | 74   | 50   |
| 65°   | 25   | 38   | 27   |
| 70°   | 6    | 15   | 7    |
| 75°   | 4    | 4    | 4    |
| 80°   | 3    | 3    | 3    |
| 85°   | 1    | 1    | 1    |
| 90°   | 0    | 0    | 0    |

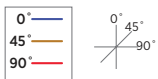
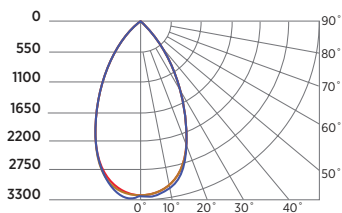
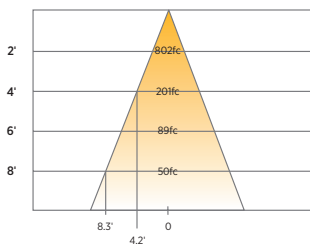

# ELEMENT™ 4" LED

ADJUSTABLE DOWNLIGHT

PROJECT INFORMATION

JOB NAME AND INFORMATION

FIXTURE TYPE AND QUANTITY

NOTES

