

VONDOM

3

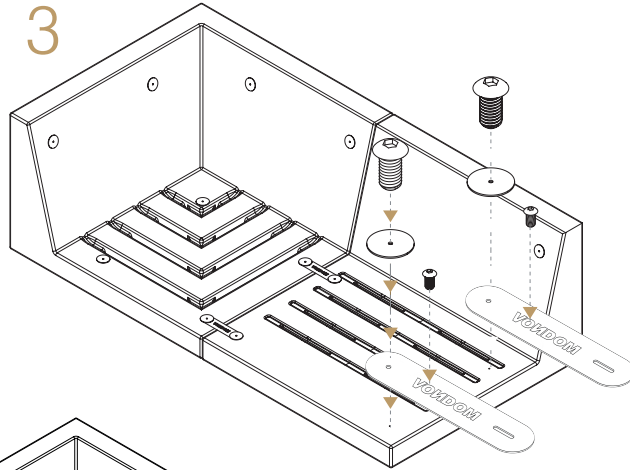

x4



4

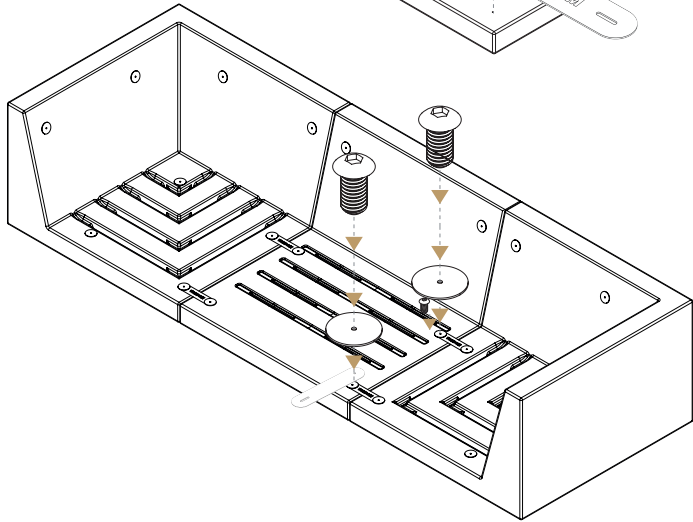

x3



5

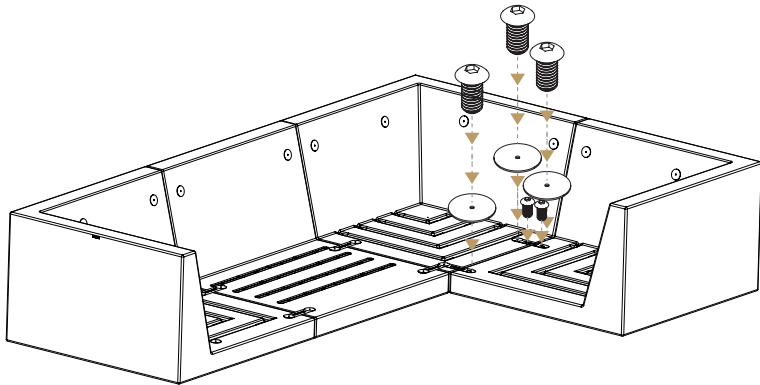

x6



Instrucciones para la unión entre módulos
Modules assembly instructions

Colección PIXEL
PIXEL collection

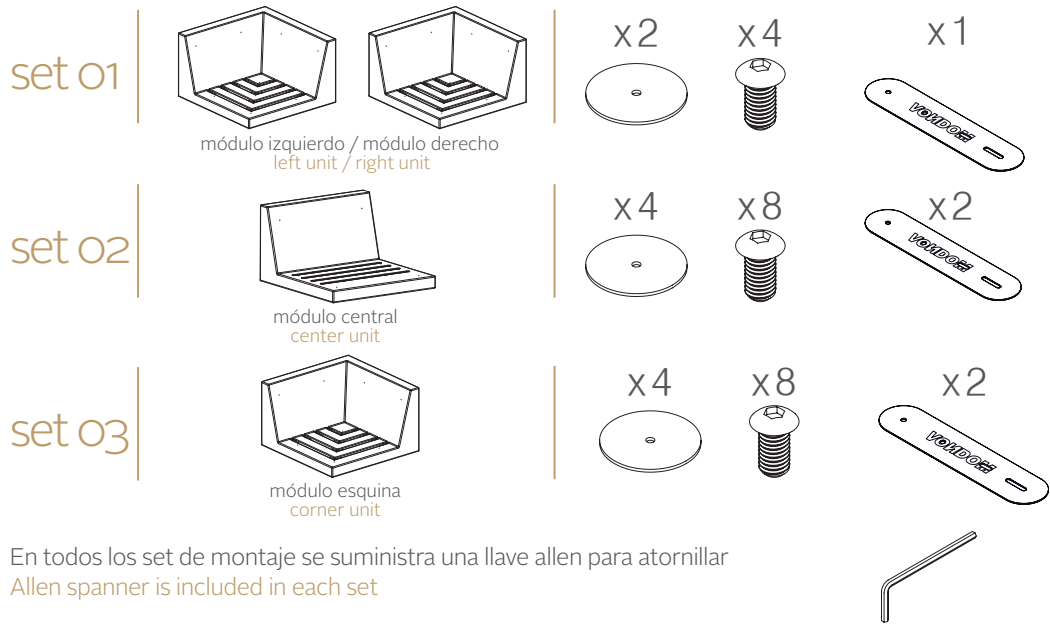

En todos los set de montaje se suministra una llave allen para atornillar
Allen spanner is included in each set

EJEMPLO DE MONTAJE 01 / ASSEMBLY EXAMPLE 01

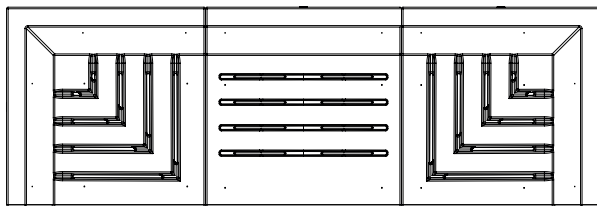

Pasos Steps

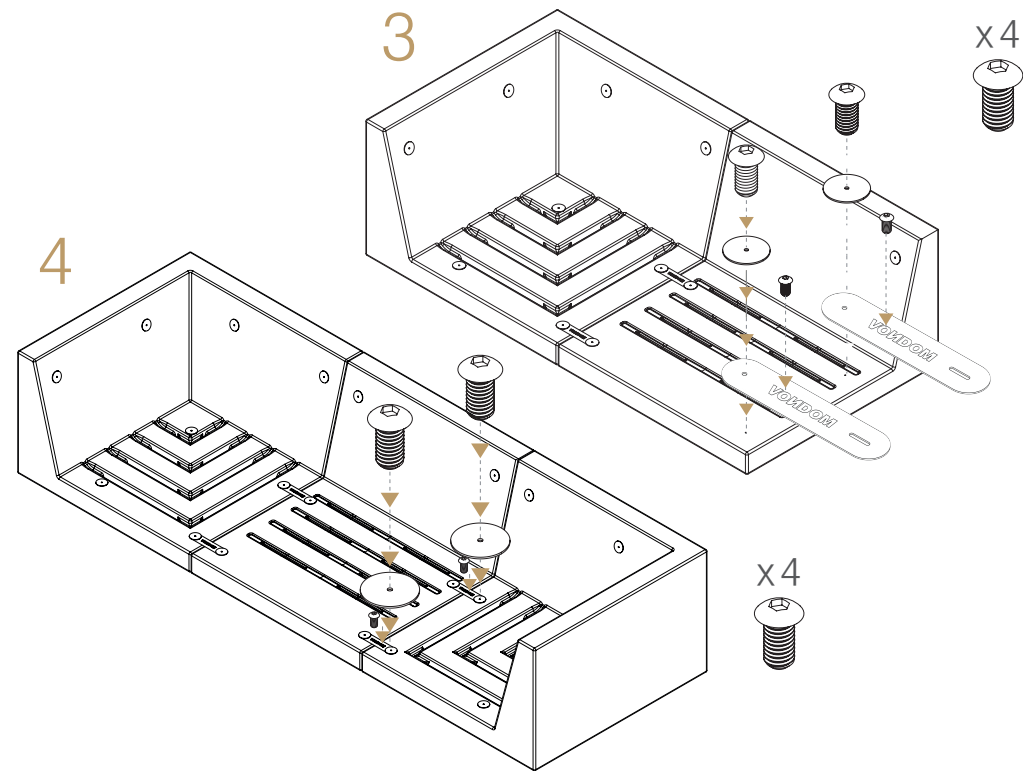
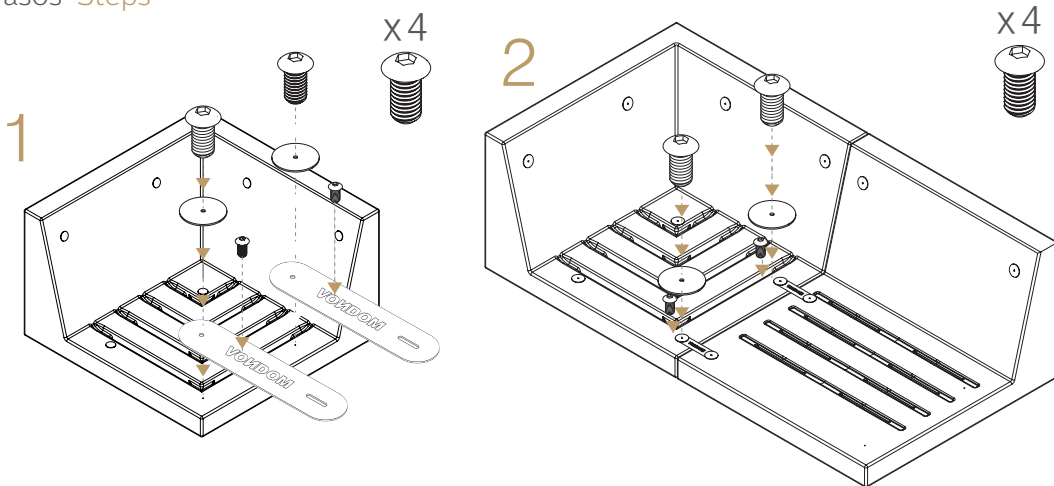

EJEMPLO DE MONTAJE 02 / ASSEMBLY EXAMPLE 02

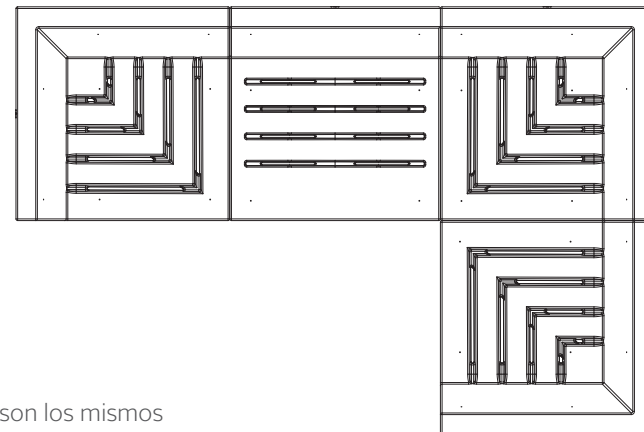

Pasos Steps

Los pasos 1 y 2 son los mismos que en el ejemplo de montaje 01
Steps 1 and 2 are the same ones that in the assembly example 01