

# TWO PARTS

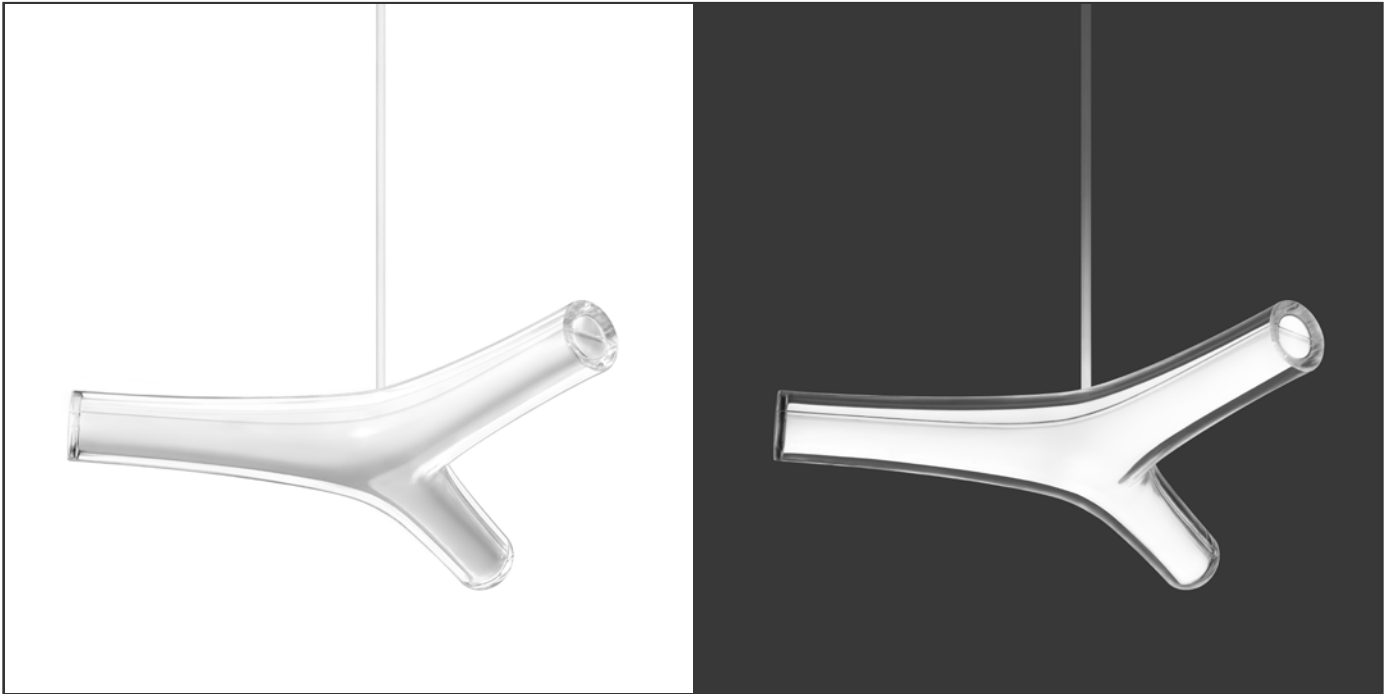

## Carbon

By Christo Logan

### Description

Indoor Pendant Fixture

### Fixture

Material: Acrylic + Polycarbonate  
Color: Clear + White  
Dims: 12.8 x 14.7 x 2.6 in  
Dims: 324 x 373 x 66 mm

### Cord

Color: White  
Length: 20 ft / 6 m

### Driver

Fits in most Junction Boxes  
Dimming: Triac, ELV, 0-10V  
Input Voltage: 100-305V AC

### LED

Input: 13W  
Output: 1000 lm  
User replaceable: No  
Life Expectancy: 50,000 hours  
Color Accuracy: CRI 95+, R9 90+  
Input: 12V Constant Voltage

### Warranty

Fixture: 5 years  
Driver: 3 years

### Certification

ETL Listed (UL + CSA Standards)  
Damp Location  
CE, RoHS

### Download CAD, Revit, IES

<http://two.parts/carbon>

### Light Temp

- CAR-CW-27 : 2700K
- CAR-CW-30 : 3000K
- CAR-CW-35 : 3500K

### Cluster Size + Driver

- 1 : 25W Driver
- 2 : 40W Driver
- 3 : 40W Driver
- 4 : Driver not included
- 5 : Driver not included
- 6 : Driver not included
- 7 : Driver not included

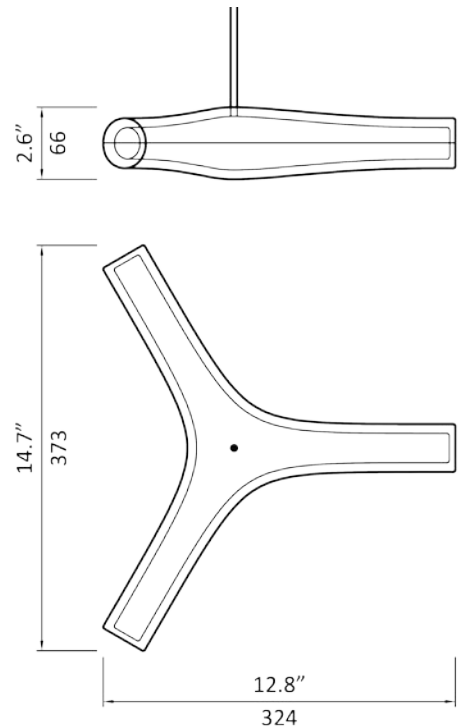

# TWO PARTS

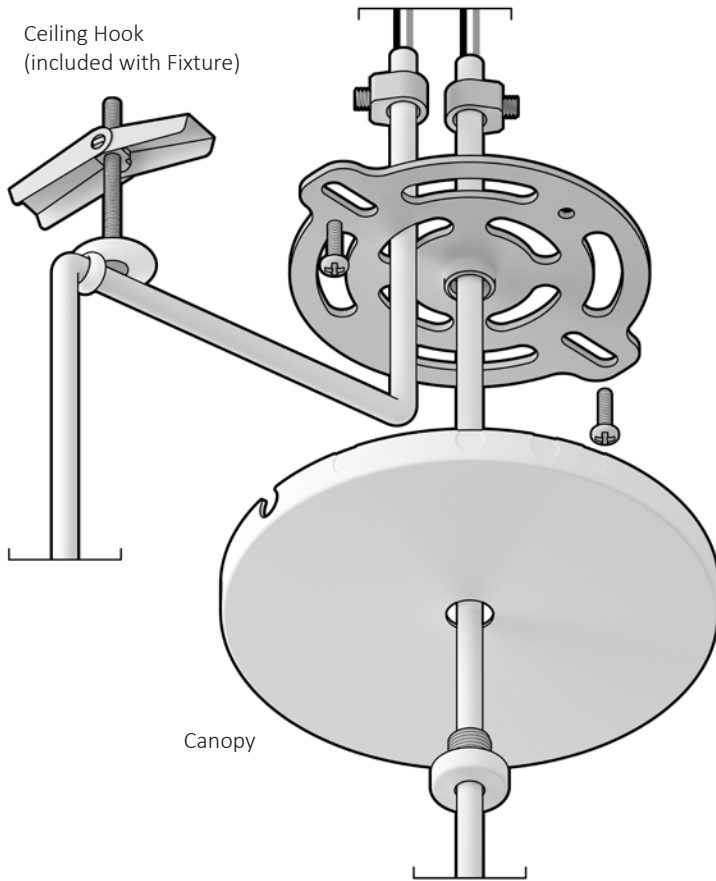

## Canopy01

By Christo Logan

### Part No

C01-W-7P

### Canopy

Fixtures Supported: 1- 7

Material: Steel

Color: White

Dims:  $\varnothing 4 \frac{1}{2} \times H3/8$  in

Dims:  $\varnothing 115 \times H9$  mm

### Features

Low Profile

No exposed screws

Side port knockouts

Center port cap

### Ceiling Hook

Included with Fixture

Screw size: #8 or M4 flathead

Material: Steel

Color: White

Dims:  $\varnothing 0.8 \times H0.4$  in

Dims:  $\varnothing 20 \times H11$  mm

### Certification

ETL Listed (UL & CSA Standards)

Damp Location

CE, RoHS

### Download CAD, Revit, IES

<http://two.parts/canopy01>

### Center & Side Mounted



1



2



3

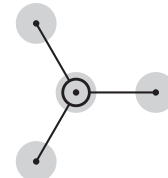

4

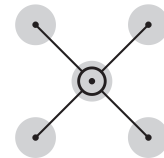

5

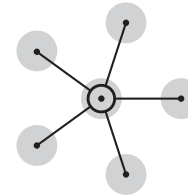

6

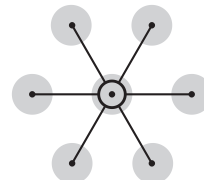

7 Fixtures

### Side Mounted Only

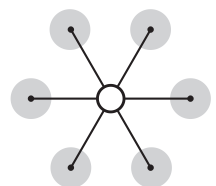
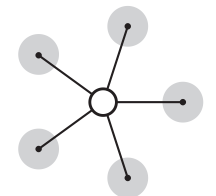
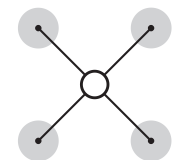
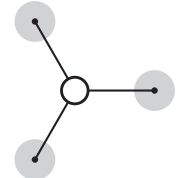
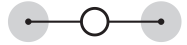
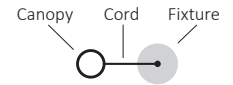

# TWO PARTS

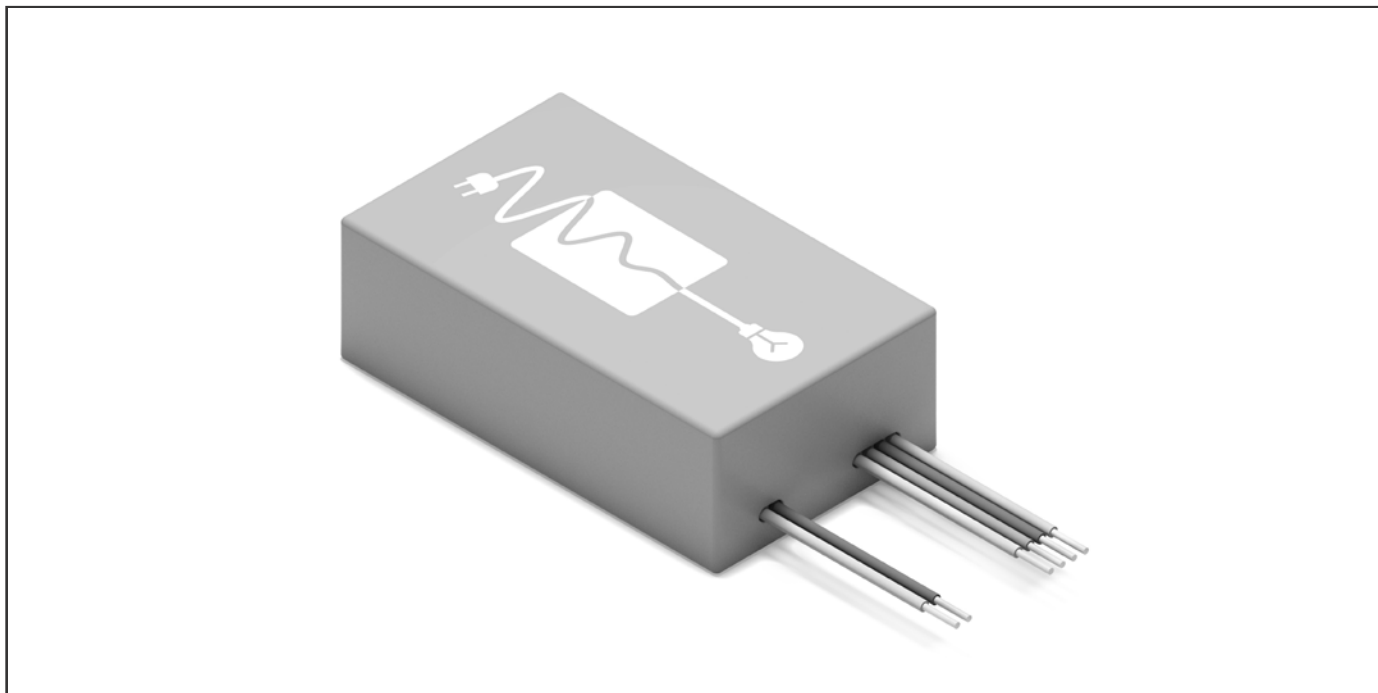

## Driver 10W

By LTF LLC

### Part No

D10W12V-UI-UD

### Description

Dimmable Low Voltage LED Driver

### Manufacturer Part

LTF DS10W12VMB1UD

### Features

Fits in most Junction Boxes  
Auto-reset, Short Circuit, Overload  
and Thermal Protection

### Warranty

3 year limited warranty

### Input

Voltage: 100-305V AC  
Frequency: 50/60Hz

### Output

Type: Constant Voltage  
Power: 10W  
Voltage: 12V DC  
Current: 833mA

### Specs

Dimming: Triac, ELV, 0-10V  
Class: Class 2 Power Supply  
IP Rating: IP67  
Humidity: 95% RH Max

### Certification

UL8750, UL1310  
CE, RoHS  
FCC Part 15 Class B Compliant

### Dimensions

2.7 x 1.6 x 0.9 in  
68 x 40 x 22 mm

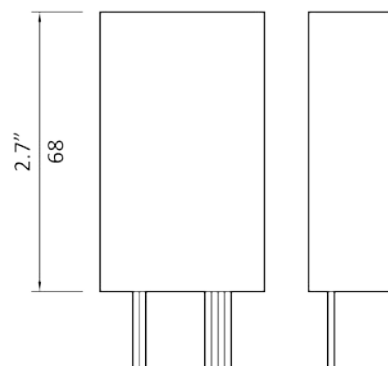
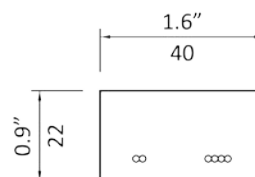

# TWO PARTS

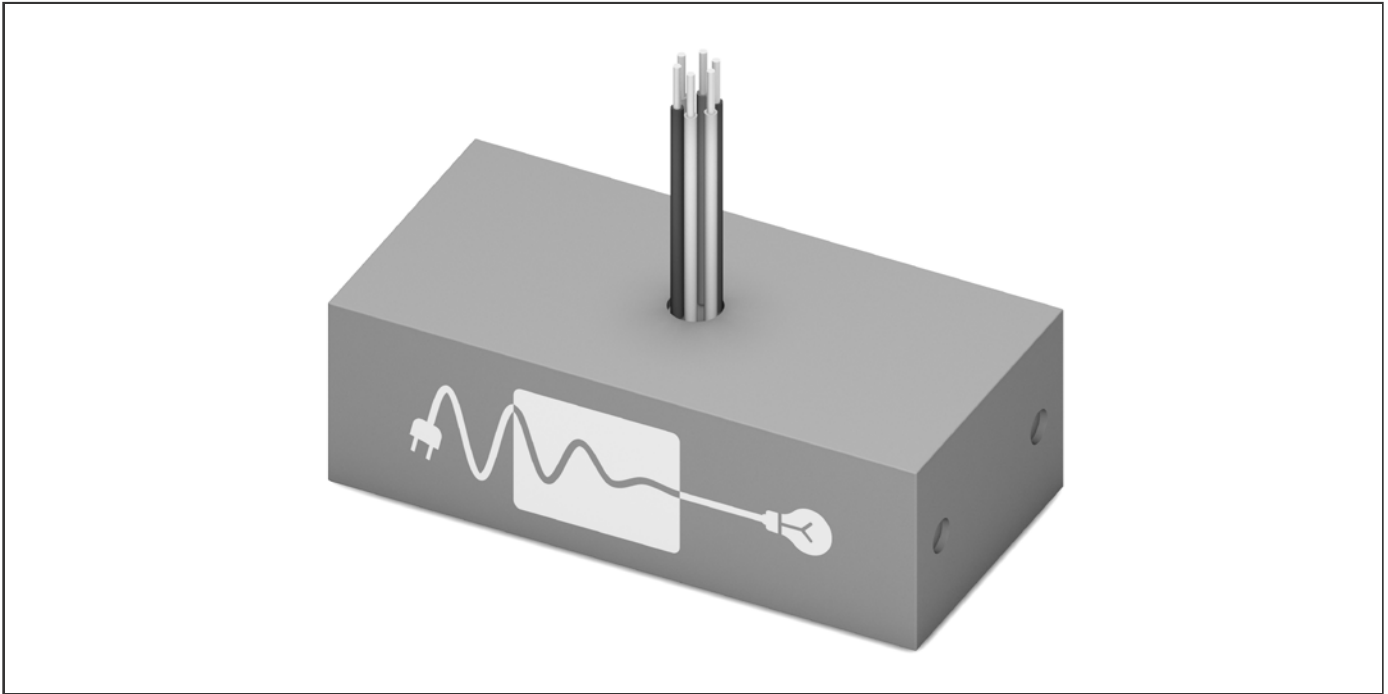

## Driver 25W

By LTF LLC

### Part No

D25W12V-UI-UD

### Description

Dimmable Low Voltage LED Driver

### Manufacturer Part

LTF DS25W12VBF1UD

### Features

Fits in most Junction Boxes  
Auto-reset, Short Circuit, Overload  
and Thermal Protection

### Warranty

3 year limited warranty

### Input

Voltage: 100-305V AC  
Frequency: 50/60Hz

### Output

Type: Constant Voltage  
Power: 25W  
Voltage: 12V DC  
Current: 2083mA

### Specs

Dimming: Triac, ELV, 0-10V  
Class: Class 2 Power Supply  
IP Rating: IP67  
Humidity: 95% RH Max

### Certification

UL8750, UL1310  
CE, RoHS  
FCC Part 15 Class B Compliant

### Dimensions

3.1 x 1.5 x 1.0 in  
78 x 38 x 26 mm

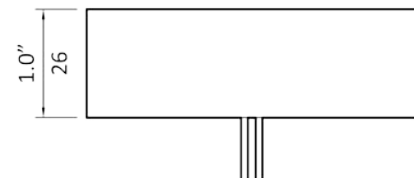
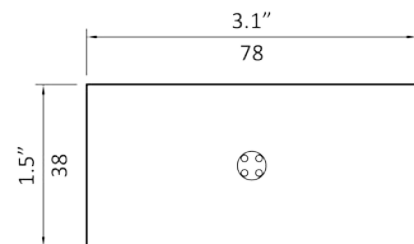

# TWO PARTS

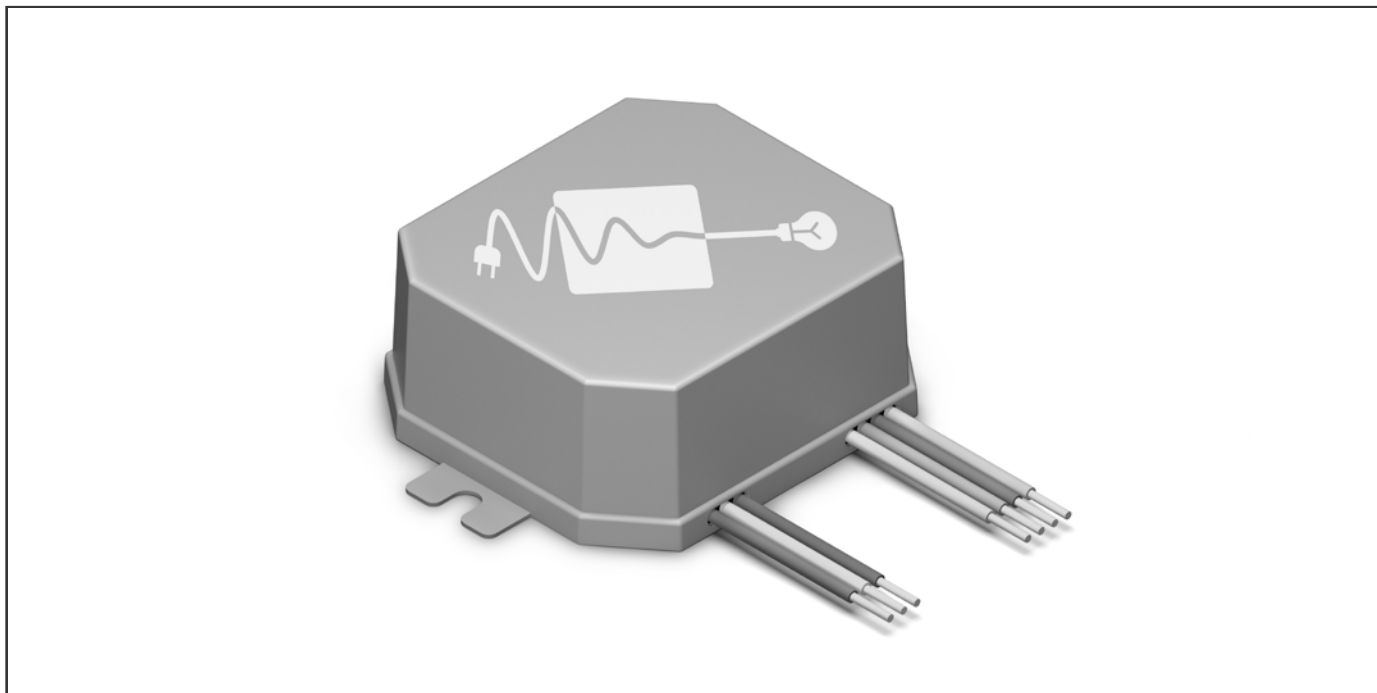

## Driver 40W

By LTF LLC

### Part No

D40W12V-UI-UD

### Description

Dimmable Low Voltage LED Driver

### Manufacturer Part

LTF DS40W12VOCUD

### Features

Fits in most Junction Boxes  
Auto-reset, Short Circuit, Overload  
and Thermal Protection

### Warranty

3 year limited warranty

### Input

Voltage: 100-305V AC  
Frequency: 50/60Hz

### Output

Type: Constant Voltage  
Power: 40W  
Voltage: 12V DC  
Current: 3333mA

### Specs

Dimming: Triac, ELV, 0-10V  
Class: Class 2 Power Supply  
IP Rating: IP67  
Humidity: 95% RH Max

### Certification

UL8750, UL1310  
CE, RoHS  
FCC Part 15 Class B Compliant

### Dimensions

3.5 x 2.5 x 1.2 in  
90 x 63 x 30 mm

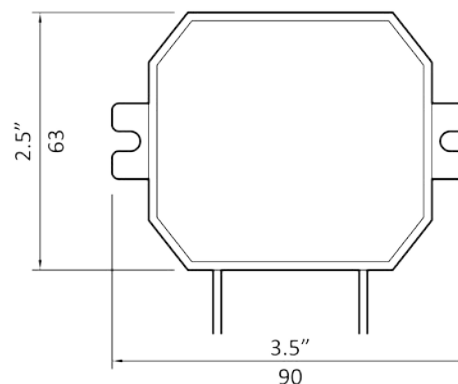
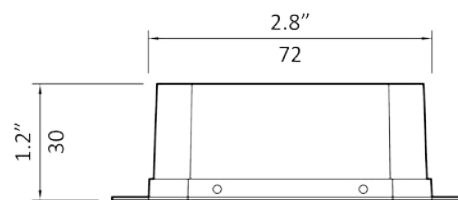

# TWO PARTS

Circuit Connector  
(customer provided)  
Must be UL/CSA/CE approved (US/Canada/  
Europe) for applicable wire gauge

LED Driver  
To be housed in accessible location  
as near as possible to Fixture.

Circuit Connector  
(customer provided)  
Must be UL/CSA/CE approved  
(US/Canada/Europe) for  
applicable wire gauge

Anchor  
Hole Ø: 9/16" or 15mm

Ceiling Hook  
Use #8 or M4 flathead  
screw located 1/2" or  
13mm shy of fixture  
location

Cord  
Side Mounted

Side Port Knockout

Building Wires  
(customer provided)

Internal Wires  
Black+ White-  
Multiple Fixtures to be wired  
in parallel to a single Driver

Cord Grip

Crossbar

Screw  
(customer provided)

Canopy

Center Port

Canopy Screw

Cord  
Center Mounted

## INSTALL GUIDE

All components are included  
unless otherwise noted.

### WARNING

Electric shock risk. Use caution  
when installing. Turn off  
electrical power at breaker  
before installation. Installation  
should be performed by a  
qualified electrician only.

The installer must ensure that  
the ceiling can support fixture's  
weight and reinforce ceiling  
structure by adequate means if  
necessary.

### MAINTENANCE

Wipe exposed surfaces with  
dry cloth as needed.

### INSTRUCTIONS

**1A Center Mount** Remove cap  
from Canopy Screw.

**1B Side Mount** Install Ceiling  
Hook(s) with loop facing away  
from canopy. Knock out side  
port(s) according to cluster  
configuration.

**2** Cut each Cord to desired  
length, leaving 3" (70mm) of  
exposed Internal Wires.

**3A Center Mount** Thread  
Cord through Canopy Screw,  
Canopy, Crossbar and Cord  
Grip.

**3B Side Mount** Thread Cord  
through Ceiling Hook, Crossbar  
and Cord Grip.

**4** Secure Cord Grip onto each  
Cord with 1/2" (10mm) of Cord  
left above.

**5** Using Circuit Connectors  
appropriate to local building  
code, connect Internal Wires  
to Driver and connect Driver to  
Building Wires.

**6** Screw Crossbar to ceiling or  
outlet box.

**7** Affix Canopy Screw to  
Crossbar with Canopy in  
between.