

## Installation Instructions for 26" Rectangle 3 Port Fast Jack Canopy

### IMPORTANT INFORMATION

- This product is ETL listed for indoor dry locations.
- This product is dimmable with a standard incandescent dimmer.
- This product can be installed to a 4" electrical box with round plaster ring, or to an octagon electrical box.

**SAVE THESE INSTRUCTIONS!**



### Install the Canopy

**A**

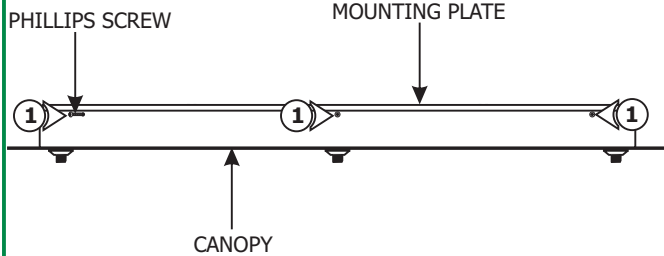

- 1:** Loosen and remove the six Phillips screws from the canopy to remove the mounting plate.

**B**

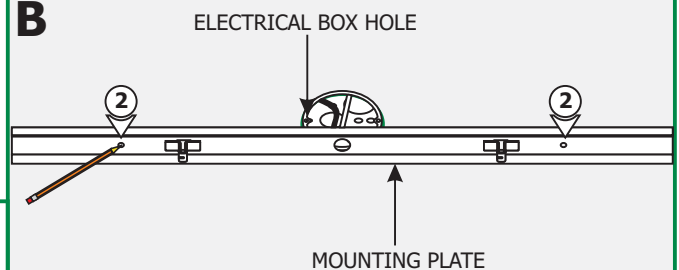

- 2:** Align the mounting plate holes with the electrical box holes and mark a point through the mounting plate holes onto the ceiling. These points are used for the anchors.

**C**



- 3:** Tap the anchors onto the marked points up to the threaded portion with a hammer.

- 4:** Screw in the threaded portion of the anchors with a Phillips screwdriver.

**D**

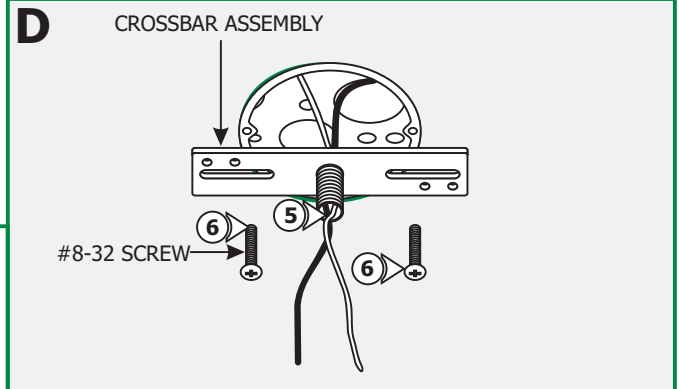

- 5:** Feed the power wires through the crossbar assembly center hole.

- 6:** Mount the crossbar assembly to the electrical box holes with the provided #8-32 screws.

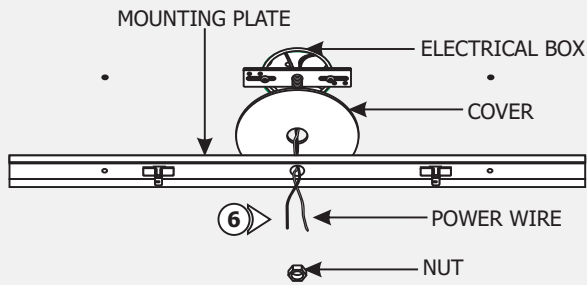
**E**

**7:** Slide the cover and mounting plate center hole onto the crossbar threaded nipple and secure it with the nut provided.

**8:** Secure the mounting plate to the anchors with the provided #8 screws.

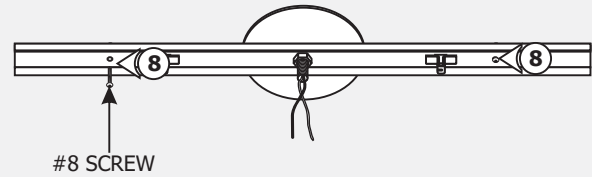
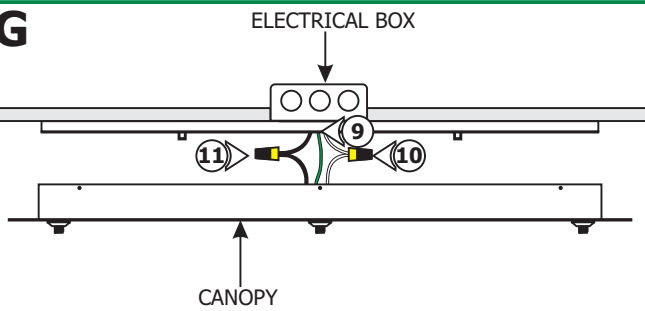
**F****G**

**9:** Make sure the mounting plate is grounded in accordance with local electrical codes.

**10:** Connect the white fixture wire to the neutral power wire with a wire nut.

**11:** Connect the black fixture wire to the hot power wire with a wire nut.

**12:** Place all the wires and wire nut connections inside the canopy.

**13:** Align and secure the canopy to the mounting plate by tightening the six #8-32 screws.

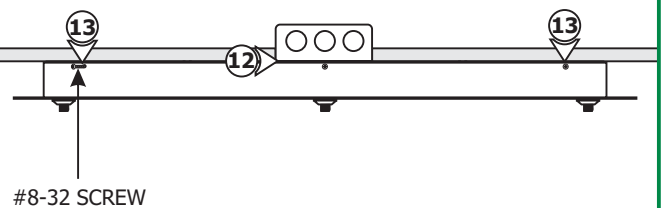
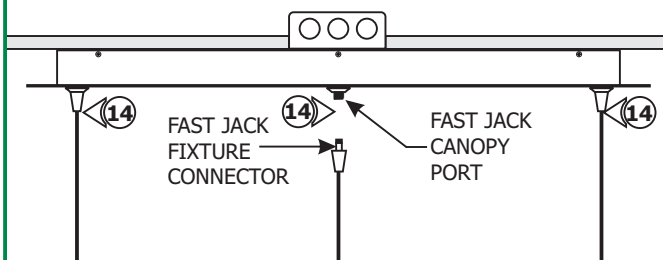
**H****I**

**CAUTION: Risk of Fire: MAX** load of each Fast Jack canopy port is **75** watt.

**14:** Use fingers to tighten each Fast Jack fixture connector into one Fast Jack canopy port.