



1718 W. Fullerton Chicago, IL 60614  
Ph: 773.770.1195 • Fax: 773.935.5613  
www.PureEdgeLighting.com • info@PureEdgeLighting.com  
© 2016 PureEdge Lighting. All Rights Reserved.

# Installation Instructions for Cirrus MIYO Triangle LED Suspension with Lit Corners - Center Feed, with Power and Remote Power

CSD\_-T-C\_-

## IMPORTANT INFORMATION

- This product is suitable for indoor locations.
- This instruction shows a typical installation.
- The fixtures with length greater than 40" for 5W and 26" for 7W will be provided with an 8" round surface mount canopy; otherwise they will come with a 4" flush canopy.
- Before beginning any electrical work, ensure that power to the junction box is turned off.

**SAVE THESE INSTRUCTIONS!**

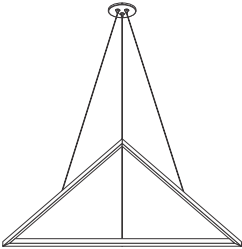

## Section One: 4" Flush Canopy

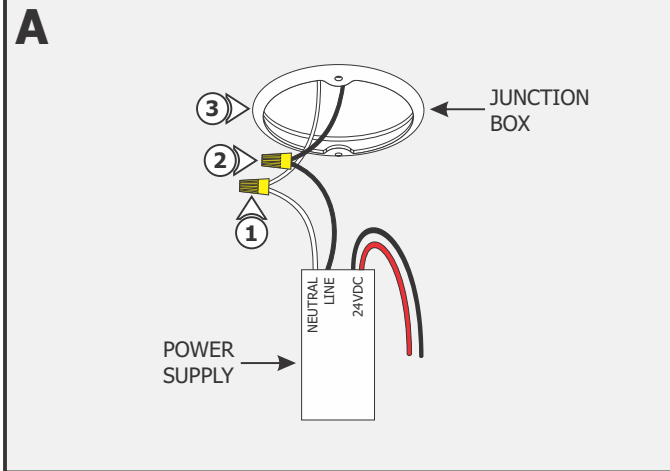

**NOTE:** Omit this section if using the 8" Surface Mount Canopy. Refer to Section Two.

**NOTE:** Omit steps 1 through 3 if using a remote power supply. Remote power supply must be installed within 40ft of the junction box. Ensure remote power supply wires are present in the junction box. Refer to the instructions provided with the power supply.

- 1:** Connect the 120V white wire of the power supply to the 120V neutral wire using a wire nut.
- 2:** Connect the 120V black wire of the power supply to the 120V line wire using a wire nut.
- 3:** Place the power supply and wires inside the junction box.

- 4:** Feed the low voltage wires from the power supply through the center hole of the mounting ring.
- 5:** Mount the ring to the junction box holes with two #8-32 screws.
- 6:** If applicable, make sure that the mounting ring is grounded in accordance with local electrical codes.

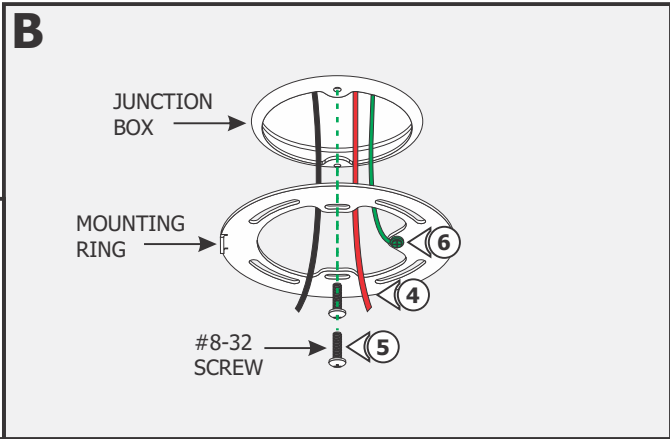

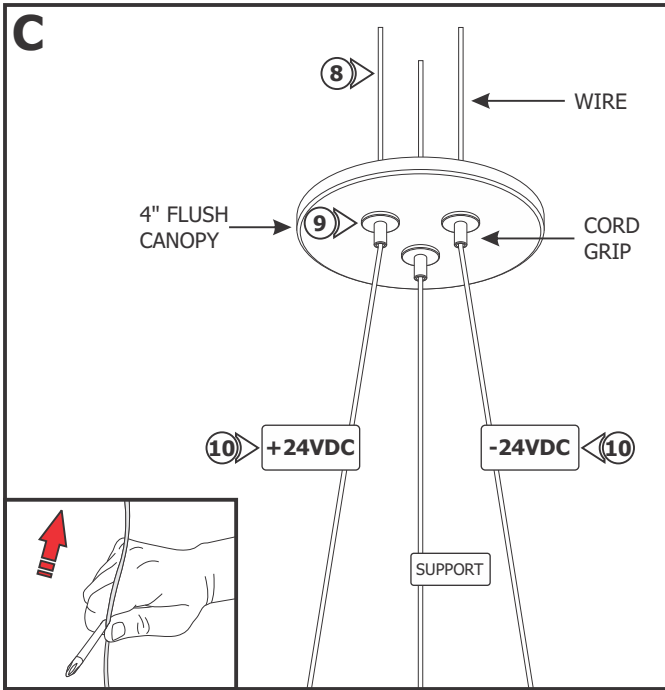

**NOTE:** Cord grips hold the fixture weight only. **DO NOT** pull on the fixture during installation or cleaning which may cause the **power wires to nick and short.**

**NOTE:** If the wire is curled or kinked, straighten by holding between the shaft of the screwdriver and thumb and pulling the wire through (see inset).

**7:** Determine the fixture height from the bottom of the channel to the top of the canopy.

**8:** Push each cable through the cord grips on the canopy.

**9:** Adjust the fixture height by pushing the cord grip tab to slide the fixture up and down. Release the cord grip tab to lock the cable in place.

**10:** Identify the **power** cables which are marked with "+24VDC" and "-24VDC" labels.

**NOTE:** The wires with "SUPPORT" labels are for support only. **DO NOT** strip and power the support wires.

**11:** Continue to Section Three to power the fixture.

## Section Two: 8" Surface Mount Canopy

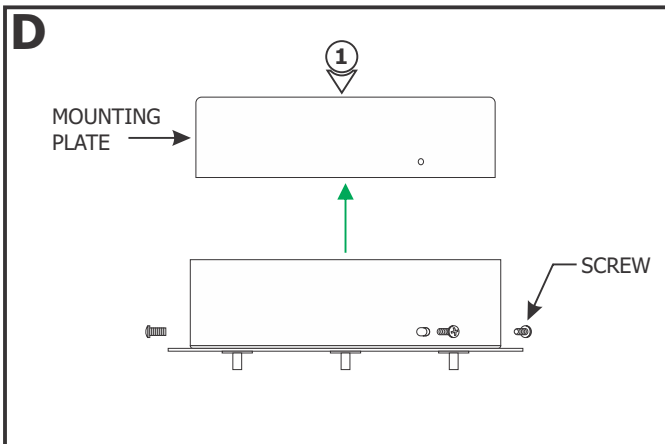

**NOTE:** Omit this section if using the 4" Flush Canopy.

**1:** Remove the three Phillips screws from the canopy to remove the mounting plate.

**2:** Align the mounting plate holes with the junction box. Mark three points onto the ceiling.

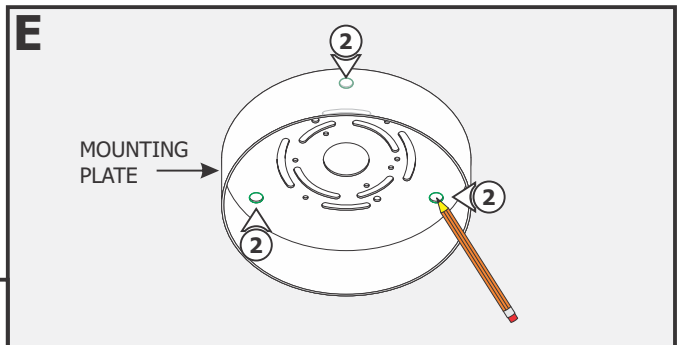

**NOTE:** Step 3 is for drywall mounting. Omit this step if mounting directly to wood surface.

**3:** Tap the anchors onto the marked points up to the threaded portion with a hammer. Then screw in the threaded portion with a Phillips screw driver.

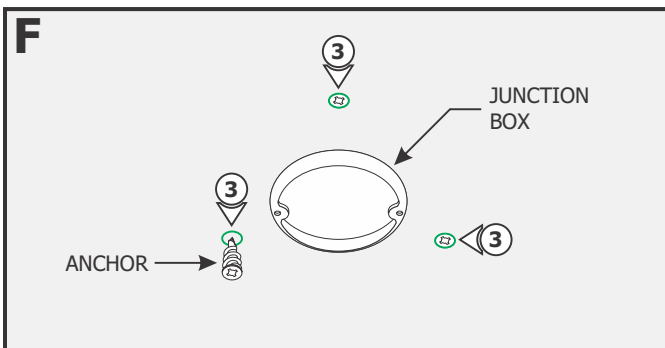

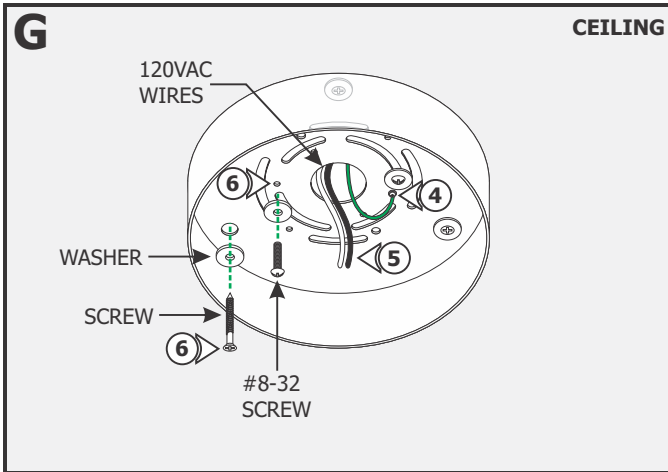

- 4:** If applicable, make sure the mounting plate is grounded in accordance with local electrical codes.
- 5:** Feed the 120VAC power wires through the center hole of the mounting plate.
- 6:** Secure the mounting plate to the junction box and anchors using the provided screws and washers.

**NOTE:** Cord grips hold the fixture weight only. **DO NOT** pull on the fixture during installation or cleaning which may cause the **power wires to nick and short.**

**NOTE:** If the wire is curled or kinked, straighten by holding between the shaft of the screwdriver and thumb and pulling the wire through (see inset).

- 7:** Determine the fixture height from the bottom of the channel to the top of the canopy.
- 8:** Push each cable through the cord grips on the canopy.
- 9:** Adjust the fixture height by pushing the cord grip tab to slide the fixture up and down. Release the cord grip tab to lock the cable in place.
- 10:** Identify the **power** cables which are marked with "+24VDC" and "-24VDC" labels.

**NOTE:** The wires with "SUPPORT" labels are for support only. **DO NOT** strip and power the support wires.

- 11:** Continue to Section Three to power the fixture.

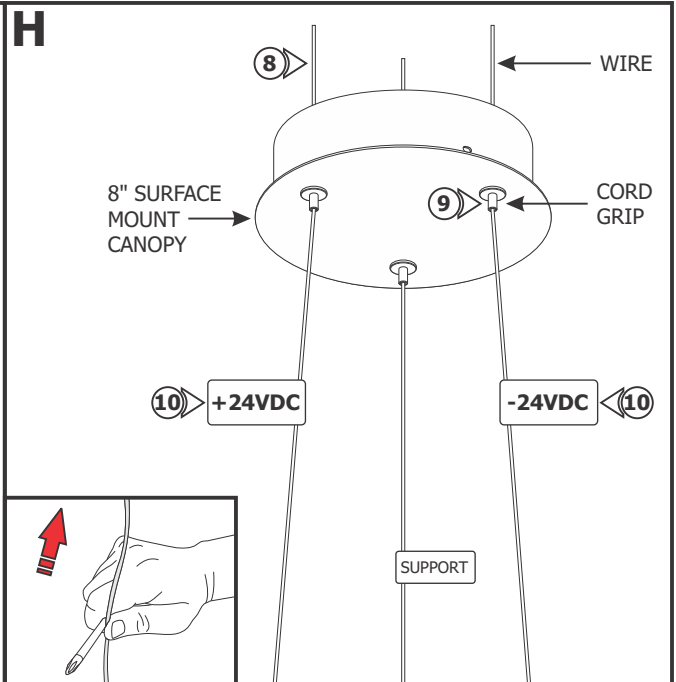

## Section Three: Power the Fixture

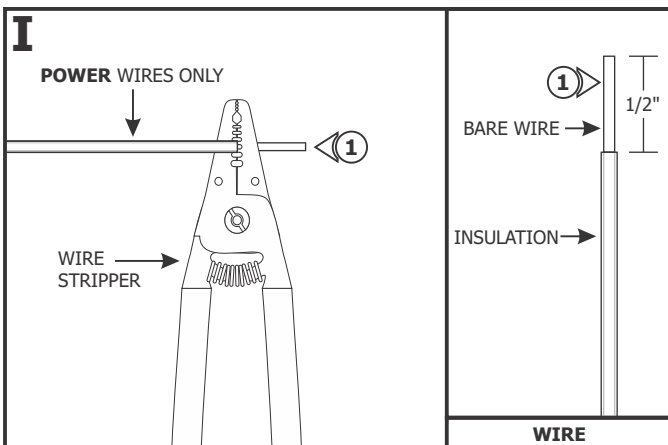

**NOTE: DO NOT** strip the support wires.

- 1:** Use the #16 gauge hole of the AWG wire strippers to strip 1/2" of the outer plastic insulation from the power wires only.

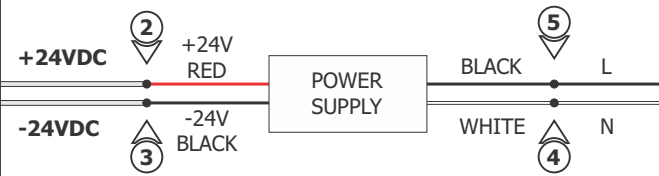
**J**

**DO NOT USE  
SUPPORT WIRES  
FOR POWER**

**2:** Connect the wire marked **+24VDC** to the low voltage +24VDC power supply wire using a wire nut.

**3:** Connect the wire marked **-24VDC** to the low voltage -24VDC power supply wire using a wire nut.

**4:** Connect the 120V white wire of the power supply to the 120V neutral wire using a wire nut.

**5:** Connect the 120 black wire of the power supply to the 120V line wire using a wire nut.

**CAUTION: Test the fixture before removing the labels.**

#### 4" Flush Canopy:

**6:** Place all wires and wire nut connections inside the junction box.

**7:** Align the canopy with the mounting ring and secure it with the two #4-40 screws using a 1/16" Allen wrench.

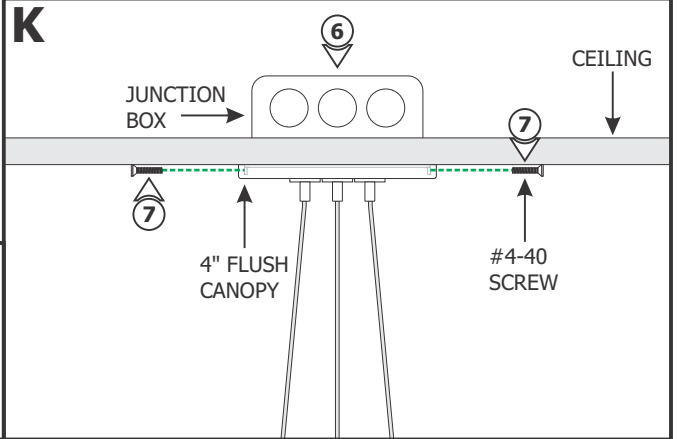
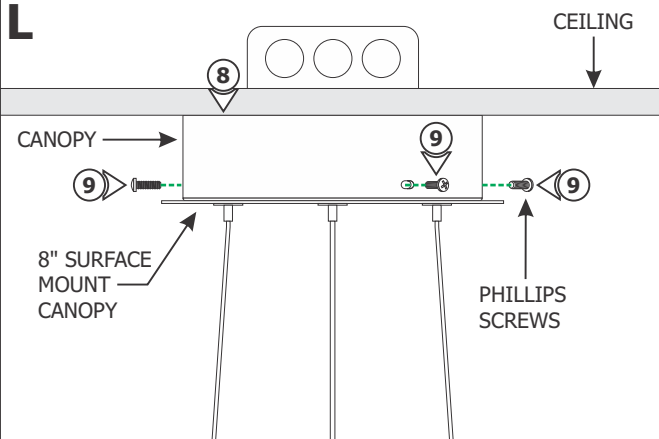
**K****L**

#### 8" Surface Mount Canopy:

**8:** Place all wires and wire nut connections inside the canopy.

**9:** Align and secure the canopy to the mounting plate by tightening the three Phillips screws.

# General Wiring Diagram

