



1718 W. Fullerton Chicago, IL 60614  
 Ph: 773.770.1195 • Fax: 773.935.5613  
 www.PureEdgeLighting.com • info@PureEdgeLighting.com  
 © 2016 PureEdge Lighting. All Rights Reserved.

## Installation Instructions for Mini Star Linear Outdoor 24VDC

MSLO-24V-\_\_\_

### IMPORTANT INFORMATION

- This instruction shows a typical installation.
- This product is suitable for outdoor locations.
- This product mounts to the ceiling, wall or floor.

**SAVE THESE INSTRUCTIONS!**

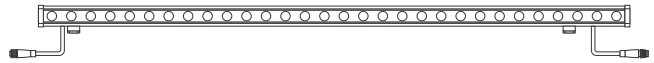

## Section One: Install the Fixture

**A**

SURFACE



**1:** Determine the location of the Mini Star fixture.

**2:** Mark the location of the mounting clips on the surface.

**B**

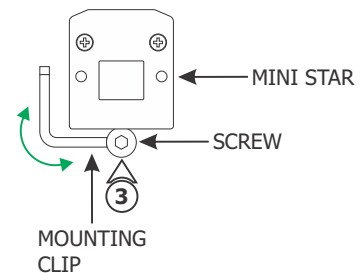

**3:** Adjust the mounting clip by loosening the screw on the side of the clip and rotating into position. Tighten the screw to secure in place.

**C**

SURFACE

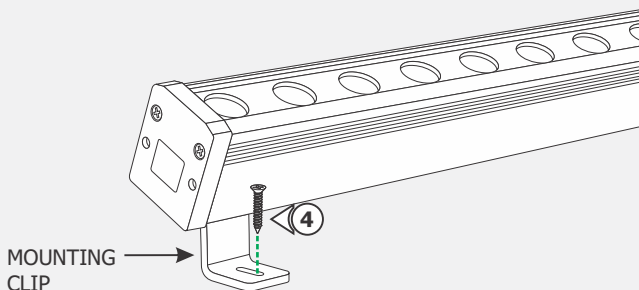

**4:** Secure the mounting clips to the surface (mounting hardware not included).

## Section Two: Power the Fixture

**D**

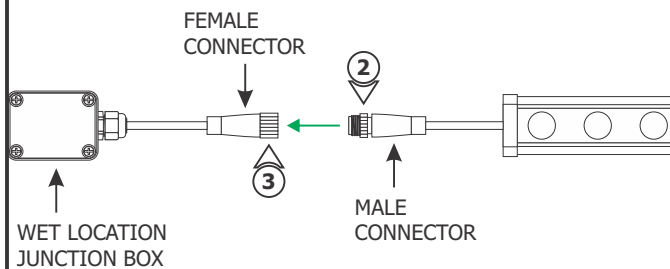

**NOTE:** Outdoor electrical connections must be made inside a waterproof junction box or using waterproof wire nut connections.

**NOTE:** Omit steps 1 through 3 if not using a wet location junction box.

- 1:** Refer to the instructions provided with the wet location junction box to connect to the power supply.
- 2:** Align and push the male connector of the fixture into the female connector going to the power supply.
- 3:** Twist the connector nut to lock in place.

**NOTE:** Omit steps 4 through 7 if using a wet location junction box.

- 4:** Cut the end of the power cord that is going to be connected to power and discard the unused connector.
- 5:** Use AWG wire trimmers to remove the outer insulation from wire harness where electrical connection will be made.

**E**

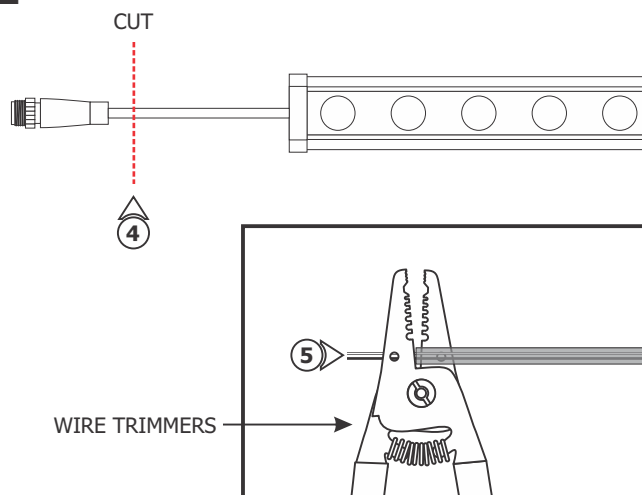

**F**

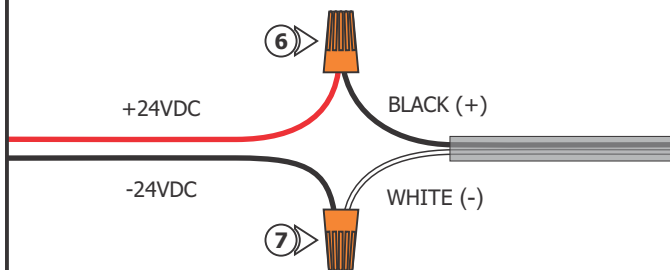

- 6:** Connect the black fixture wire to the +24VDC power supply wire using a wire nut.
- 7:** Connect the white fixture wire to the -24VDC power supply wire using a wire nut.
- 8:** Refer to the wiring diagram on page 3 and the instructions provided with the power supply to complete the installation.

**9:** To connect additional fixtures, align and push the female connector of one fixture into the male connector of the next one.

**10:** Twist the connector nut to lock in place. Repeat for any additional sections.

**G**

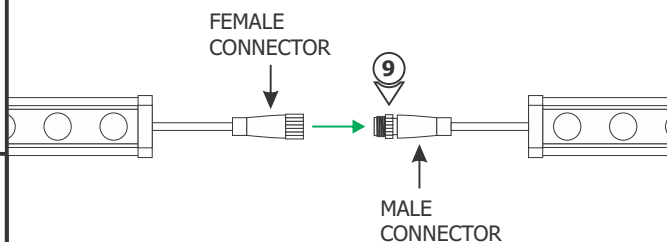

# General Wiring Diagram

