

AJ 50 WALL

The fixture emits downward directed light. The shade is painted white on the inside to ensure a soft comfortable light distribution.

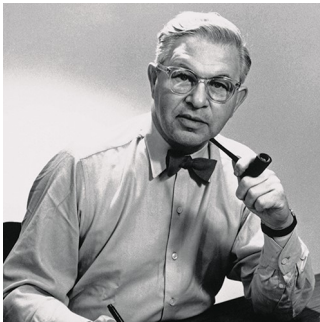

Arne Jacobsen

Arne Jacobsen was born and raised in Copenhagen. In 1927, he graduated as an architect from the Royal Danish Academy of Fine Arts in Copenhagen. After graduating, he obtained his first job at the office of the City Architect of Copenhagen launching his own office only two years later.



Cocks & Cows



Skagen

Product info

Information

Electrical: System Wattage: 9 W LED Wattage: 8 W Delivered lumens: 504 lm Efficacy: 56.0 lm/W Certifications: cULus, Wet Location Protection class IP65 IK class 06 BUG Rating: B0-U1-G0 Controllability: Phase dimming Min.-Max. Ambient Temp: -30°C to +40°C Color Rendering: Ra≥90

Mounting

Surface: Mounted directly to finished surface over a 4" octagonal junction box.

Finish

Black, white or natural painted aluminum, textured powder coated.

Materials

Back plate: Die cast aluminum. Shade: Die cast aluminum. LED enclosure: frosted glass.

Compliance

cULus, Wet location.

Light source

LED 3000K (ra90)
Lumen: 504

Information

Electrical:
System Wattage: 9 W
LED Wattage: 8 W
Delivered lumens: 504 lm
Efficacy: 56.0 lm/W
Certifications:
cULus, Wet Location
Protection class IP65
IK class 06
BUG Rating: B0-U1-G0
Controllability: Phase dimming
Min.-Max. Ambient Temp: -30°C to +40°C
Color Rendering: Ra≥90

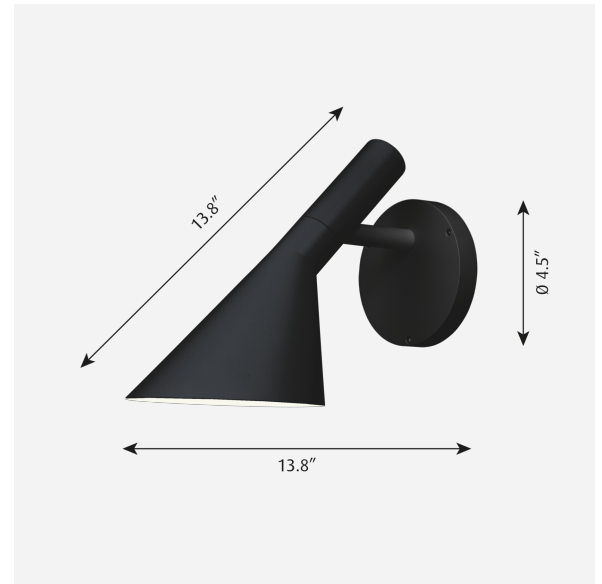

Related products



AJ Floor



AJ Table

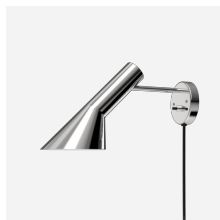

AJ Wall



AJ Royal



AJ Mini Table



AJ Garden Bollard

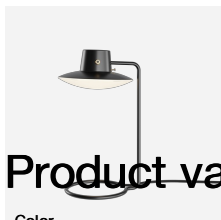

Product variants

Color	Light source	Voltage frequency
AJ Oxford Table Lamp <input checked="" type="radio"/> Black texture <input type="radio"/> Natural paint aluminum <input type="radio"/> White texture	LED 3000K (ra90)	120V

Product description

Iconic design by Arne Jacobsen, renowned Danish designer. Compact outdoor wall fixture with recessed LED light source emits downward light. Available standard finish colors include black, white and natural aluminum paint with white on the interior.

Mounting

Surface: Arm mounted to the wall with escutcheon plate, centered over recessed junction box. Three 0.2 inch diameter mounting holes arranged in a 4.9 inch diameter 120 degrees apart. Mounting hardware by others.

Light description

The luminaire emits glare-free light directed downwards. The LED is enclosed by a frosted polycarbonate lens, ensuring uniform light. Features good, functional and pleasant lighting comfort. Standard CCT in 3000K or 4000K, controlled by phase dimming.

Design

Arne Jacobsen

Material

Shade and escutcheon plate: Die cast aluminum, 0.1" thick. LED enclosure: frosted polycarbonate, 0.1" thick.
Standard finish are matte, textured surface powder coat with minimum 2 mils thickness in black, natural painted aluminum, or white.

Weight

Min: 4.217 lbs Max: 4.431 lbs

Other functions

LED in 2700K, 3500K, 4000K, 5000K, or 5700K. Amber LED available for sea turtle nesting areas. Custom finishes.

Finish

Black texture, Natural paint aluminum, White texture

Voltage

120V

Light distribution diagrams

Cartesian

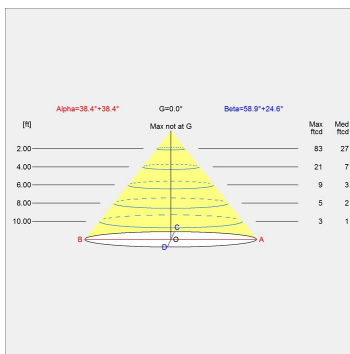

Isolux

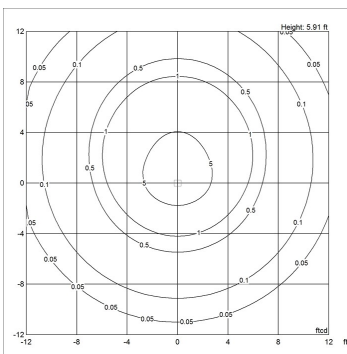

Polar

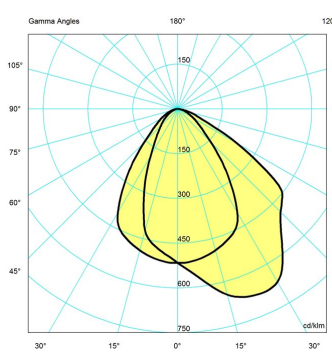

Bug

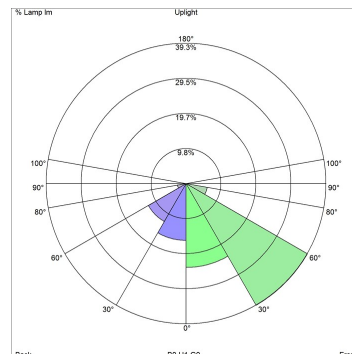

Spare parts & accessories

Product

GRUB SCREW MS M12X12 (3PCS)

Variant number

574314587