

BuzziJet

INSTALLATION MANUAL

MODE DE L'EMPLOI

120V-277V

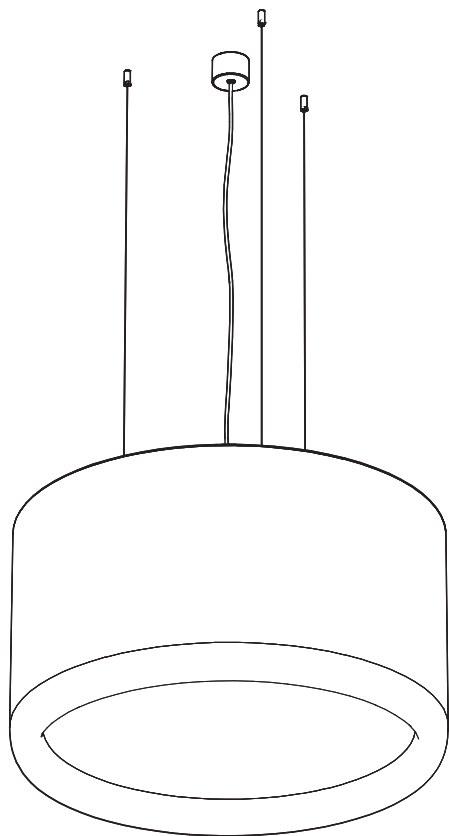

Technical info

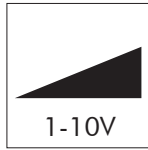
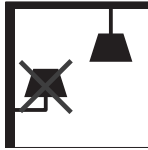
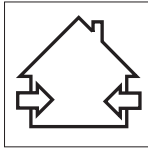

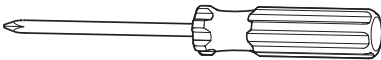
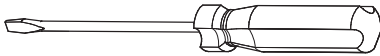

⚠ The light source of this luminaire is not replaceable; when the light source reaches its end of life the whole luminaire shall be replaced.

Excl.

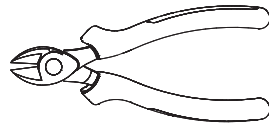
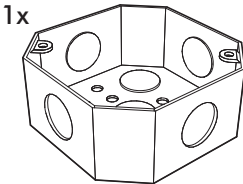
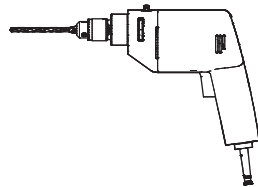

2x 



Straight 3x
Split 1x 

2x 

BuzziJet Ceiling Suspended Straight

2 PERS. 

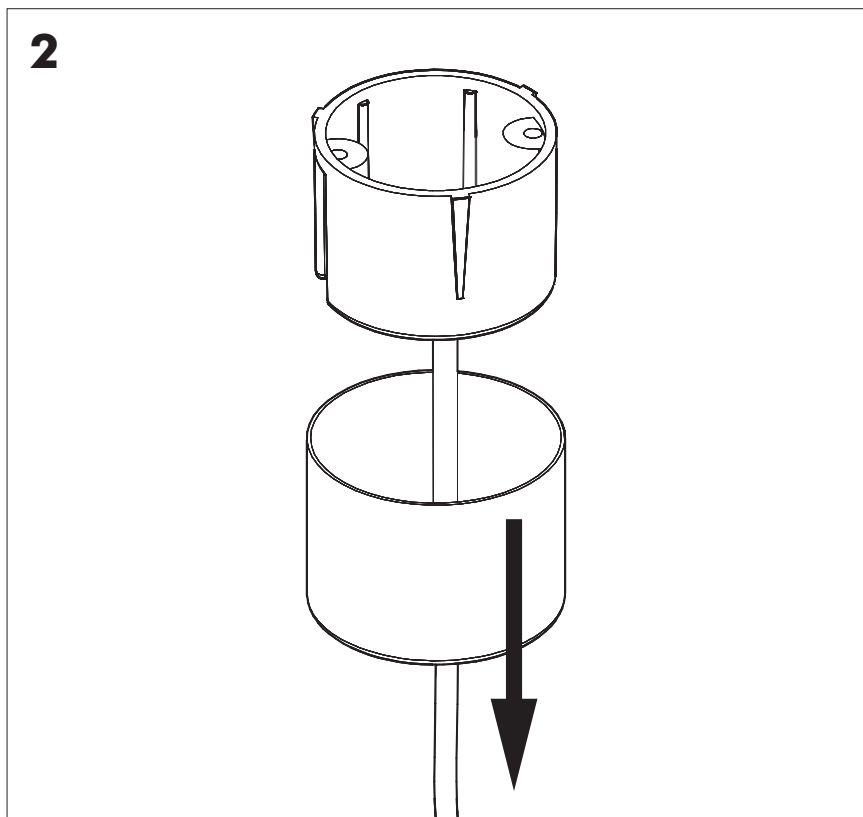
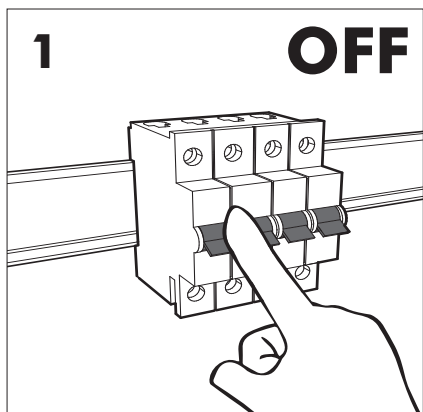
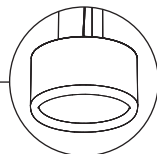

3

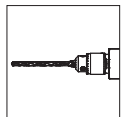
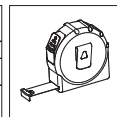
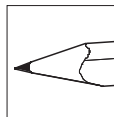
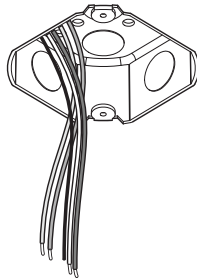
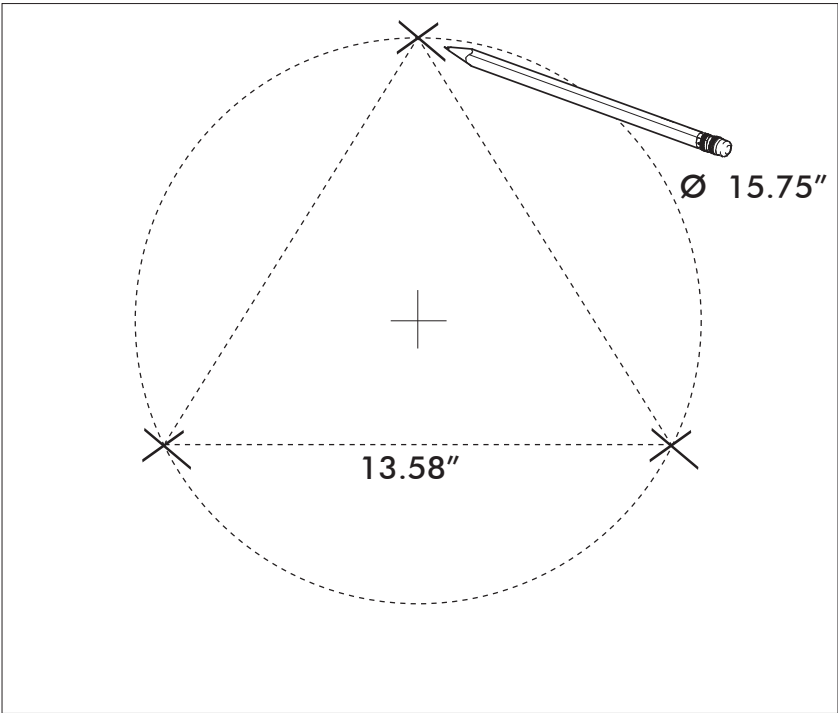

4

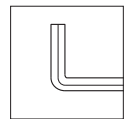
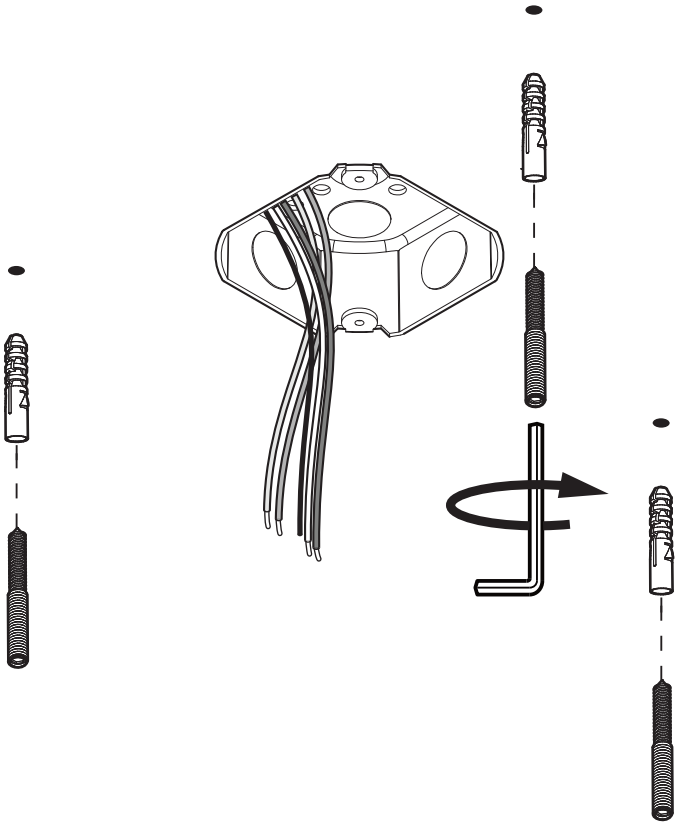

5

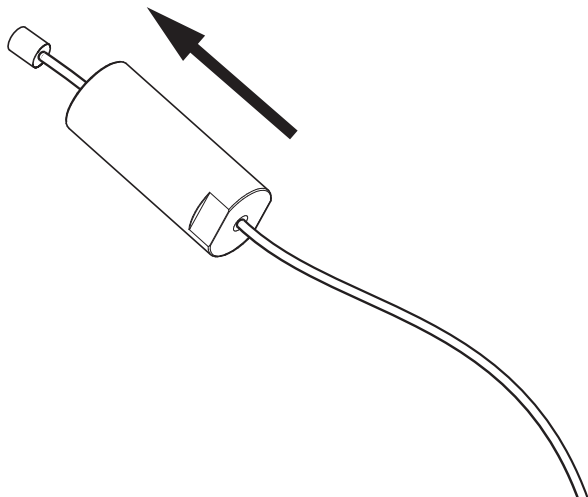
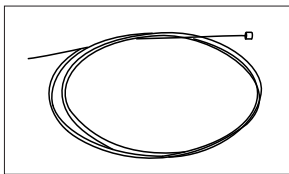

6

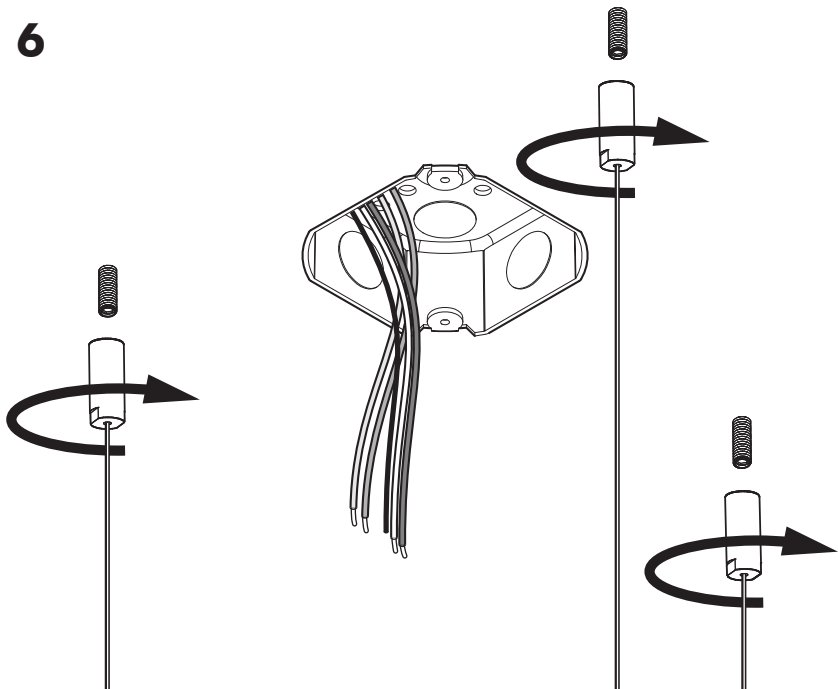

7

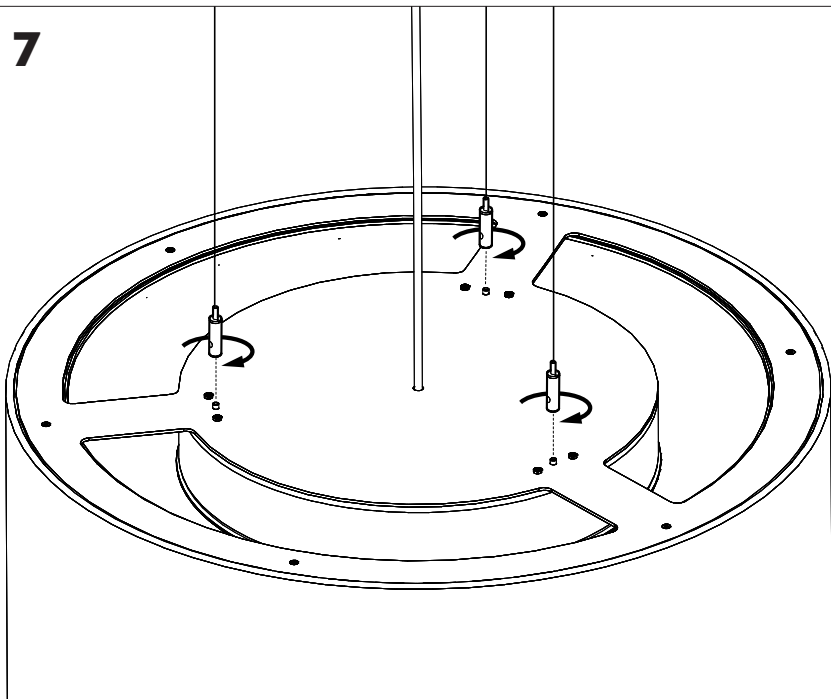

8

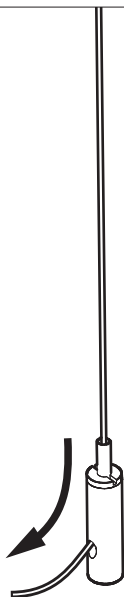
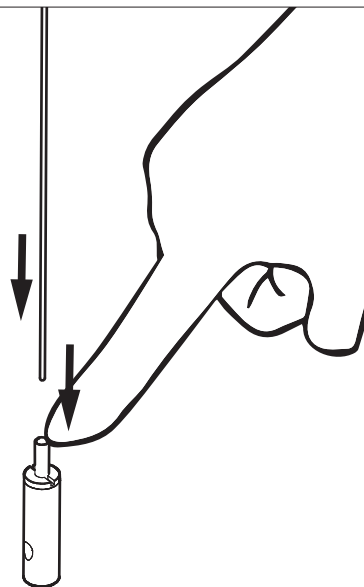

9a

Connection including dimmable function

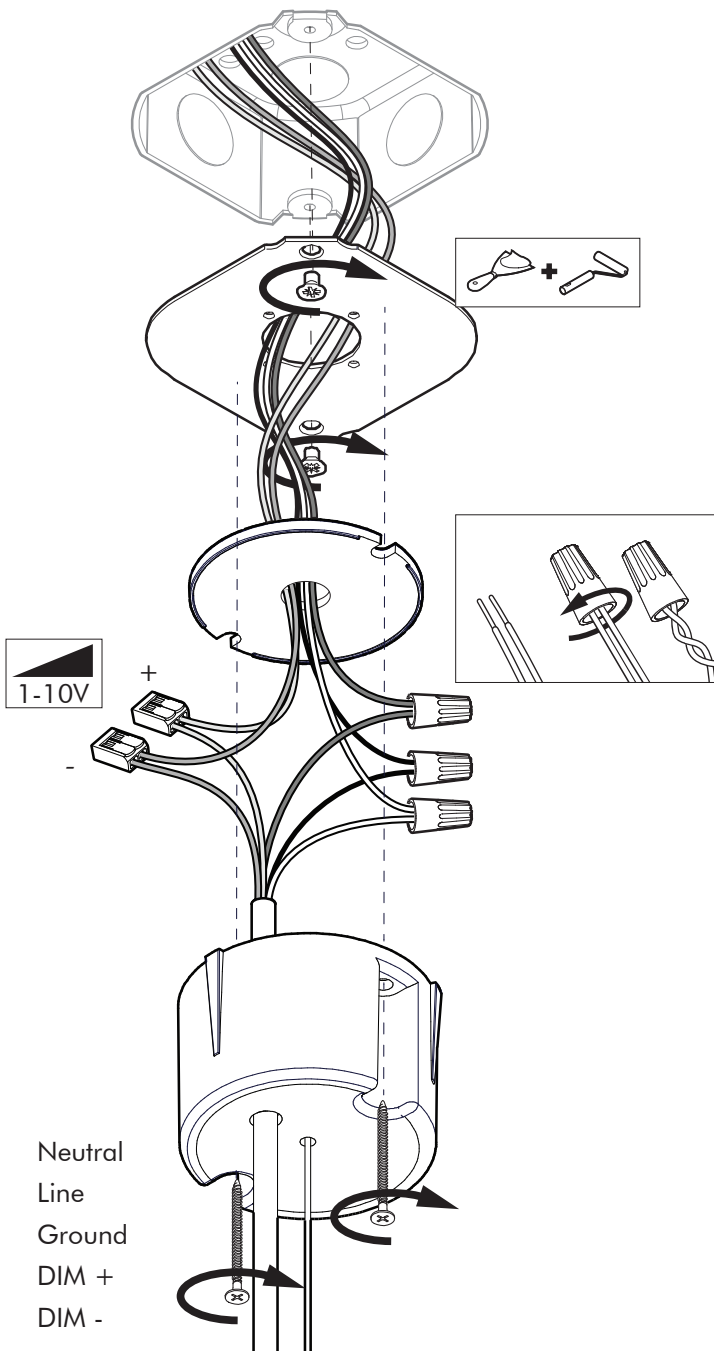

9b

Connection excluding dimmable function

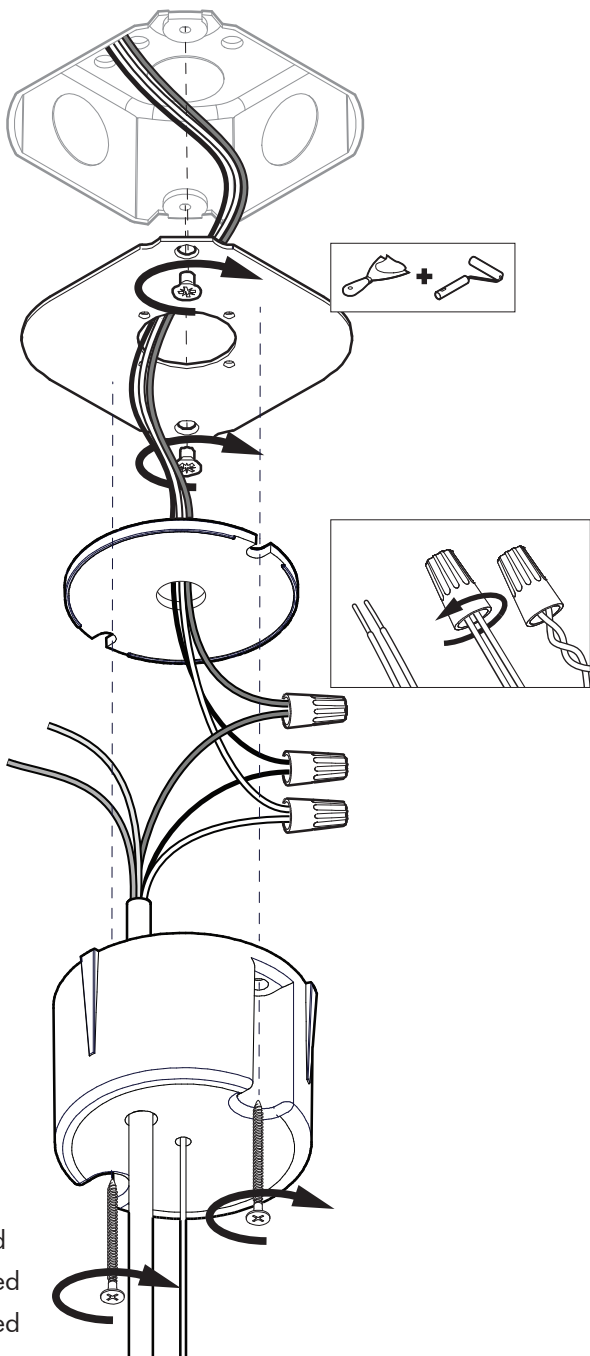

10

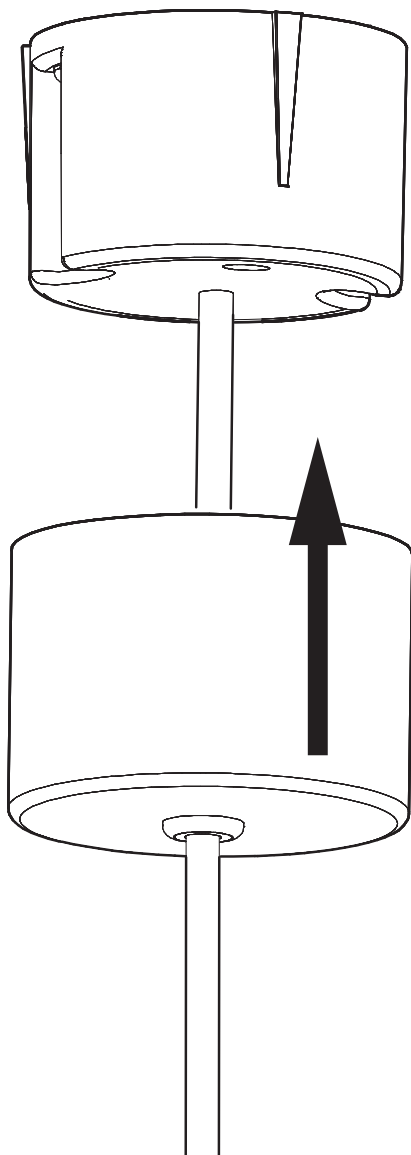

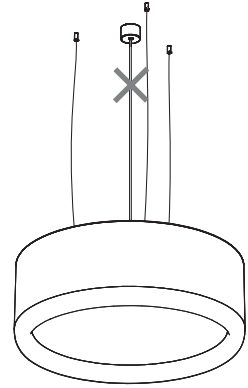
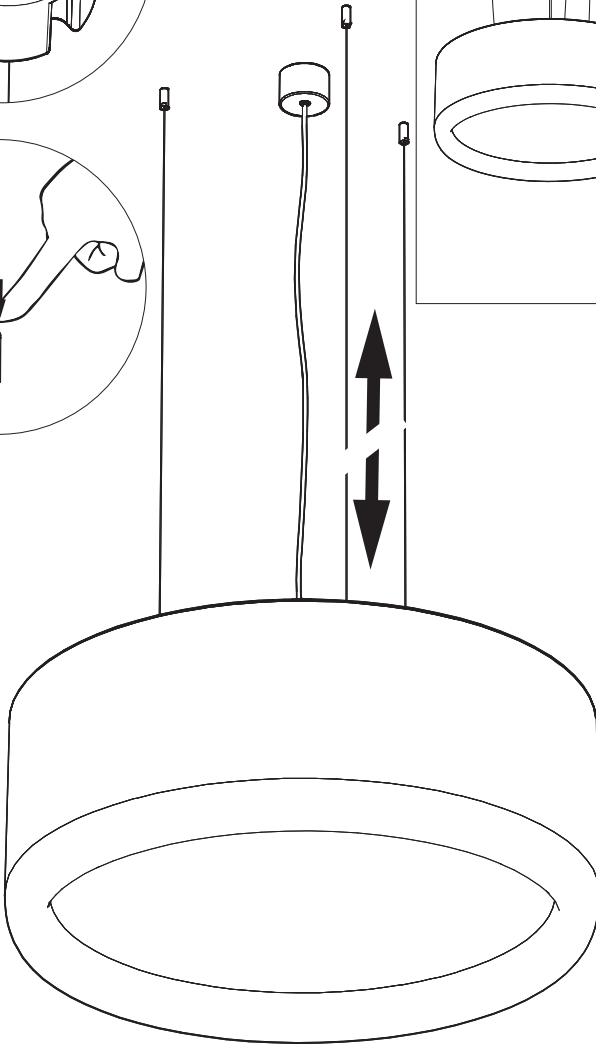
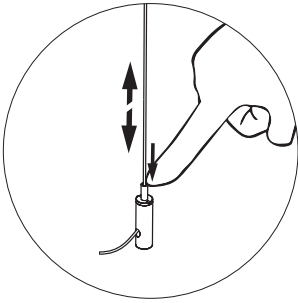
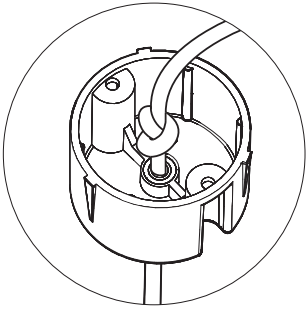

BuzziJet Ceiling Suspended Split

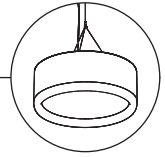

2 PERS. 

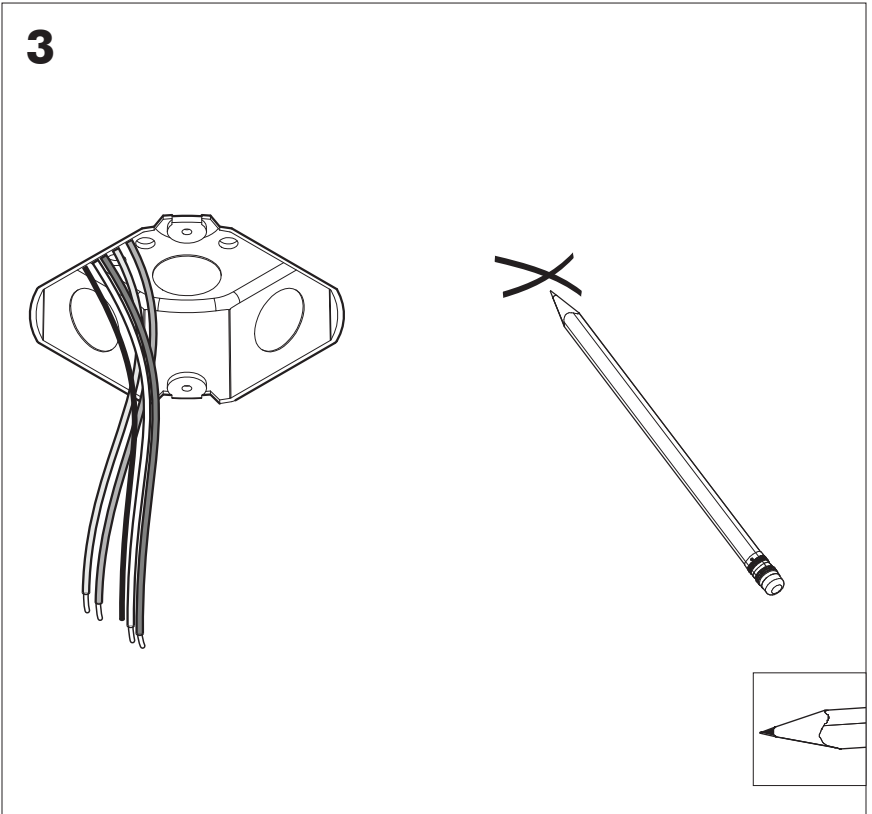
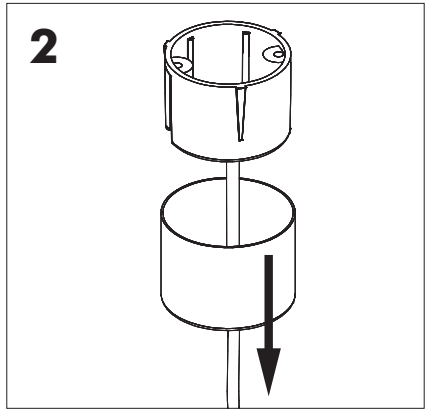
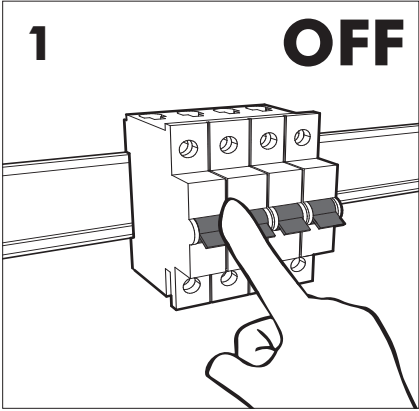

4

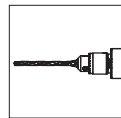
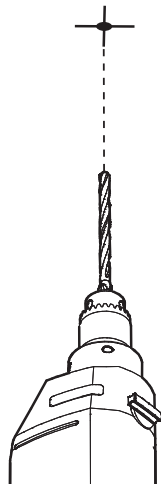
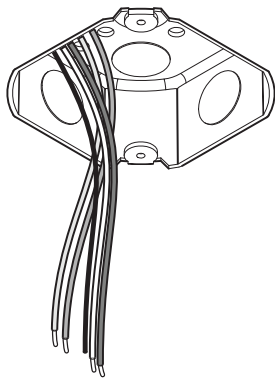

5

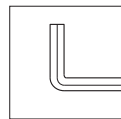
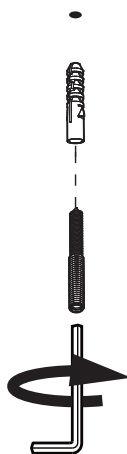
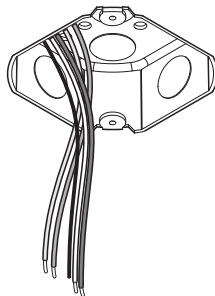

6

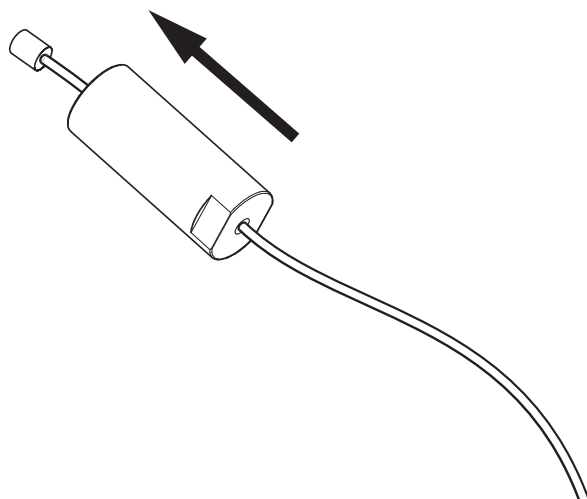
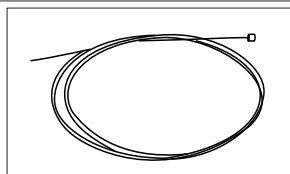

7

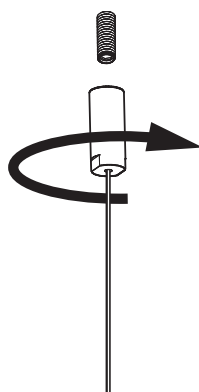
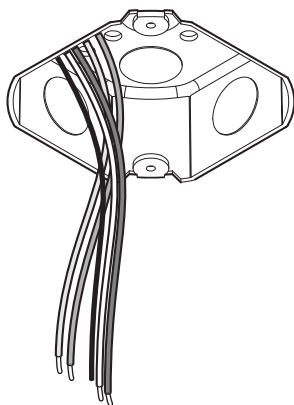

8

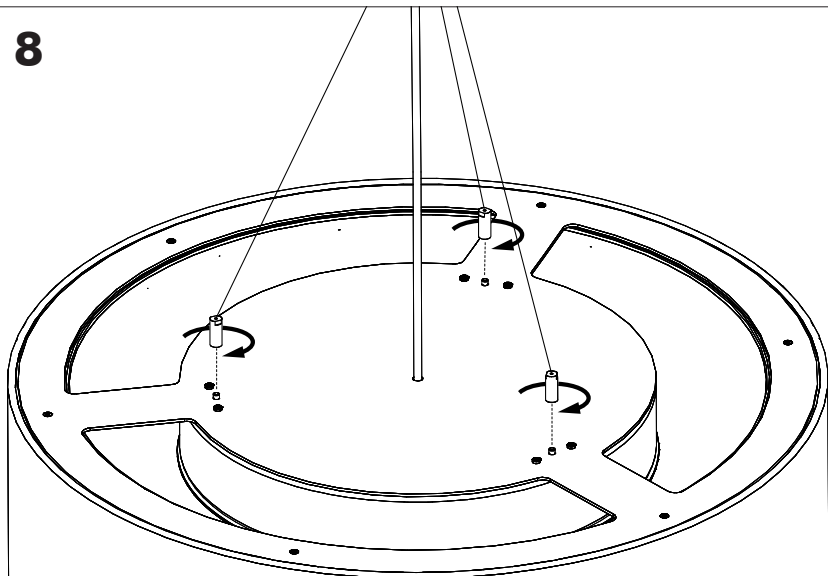

9

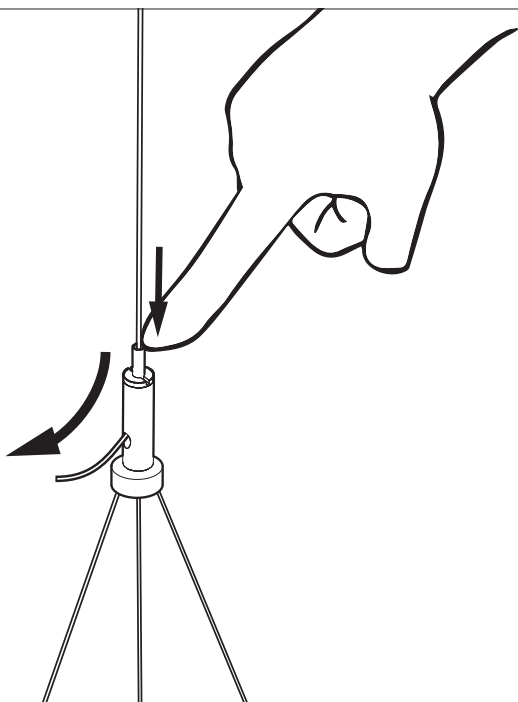

10a

Connection including dimmable function

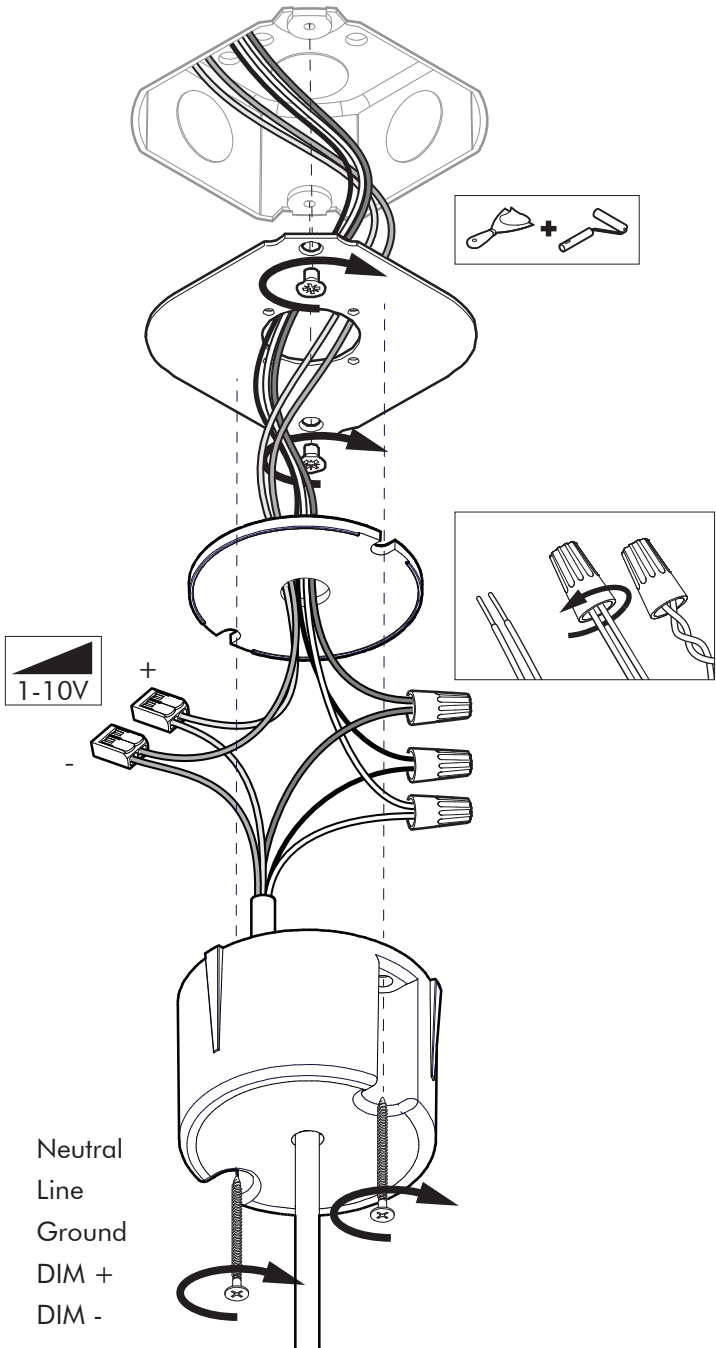

10b

Connection excluding dimmable function

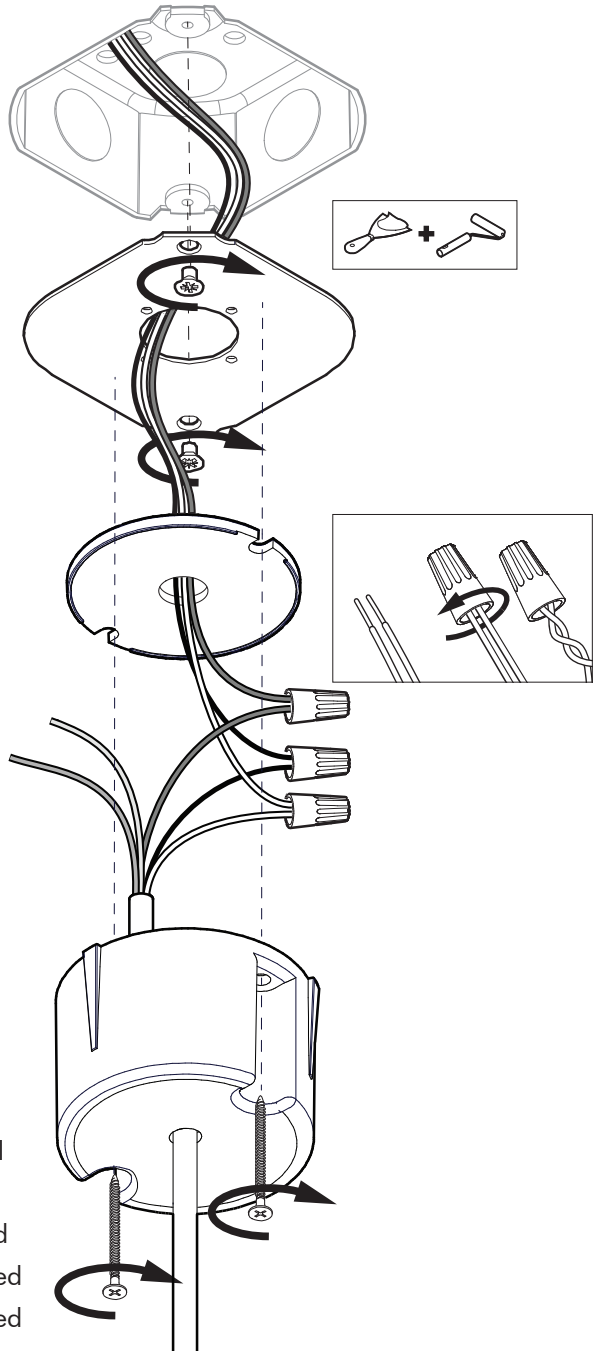

11

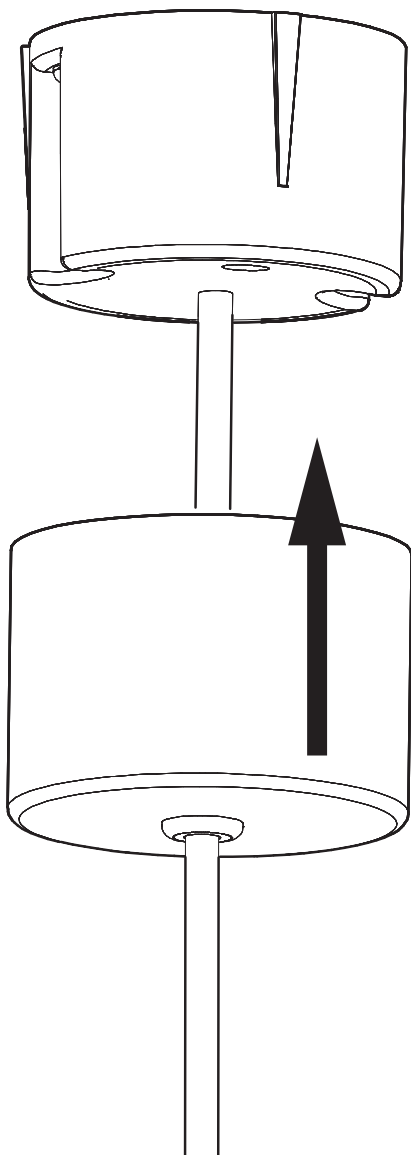

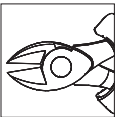
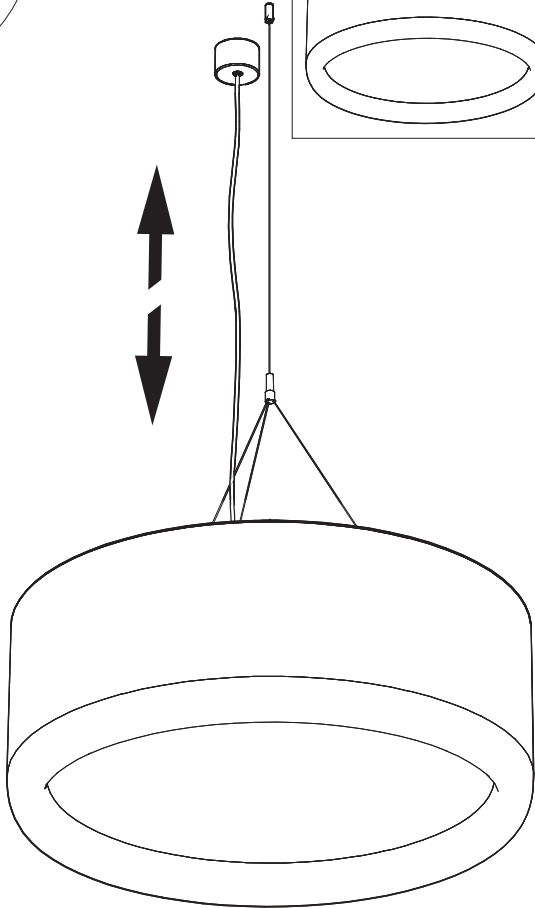
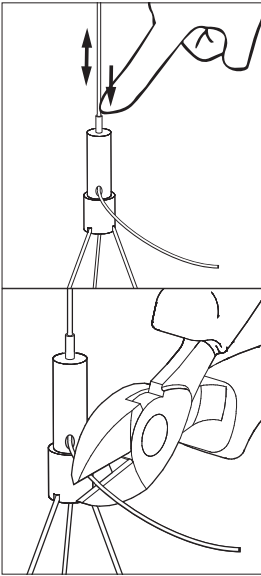
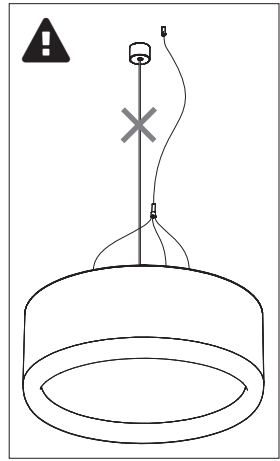
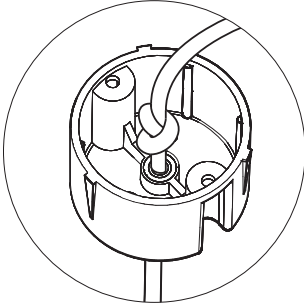

BuzziSpace
Groeningenlei 141
2550 Antwerp, Kontich
Belgium
☎ +32 (0)3 846 10 00
✉ info@buzzi.space
🌐 www.buzzi.space



A-0000003387/03
Last update: 06/05/2021