

SETUP



lzf

GEA

G 20 A, G 30 A, G 42 A GX53 UL

CONTENTS

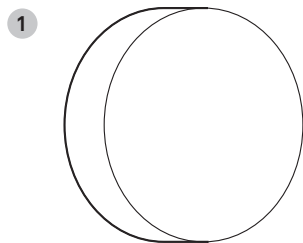

- 1 Shade / electrical back plate 1 un.
- 2 Screws 2 un.
- 3 Allen key No. 2,5 1 un.

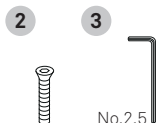

TECHNICAL SPECIFICATIONS

Recommended bulb

120V



120V GX53 Base



CFL Slim spiral 1 x 6 W max.

WEIGHT	G20A	G30A	G42A
Net Weight	1,3 Lb	2,0Lb	4,0Lb
Gross Weight	2,6 Lb	5,3Lb	9,3Lb

WARNINGS

Before assembly and installing this product, carefully read the following:

Turn off the mains before installing the lamp. Dry location only. This lamp is for indoor use only.

WOOD VENEER: Due to the natural nature of the material sometimes one may note slight undulations in the wood veneer. This is a natural reaction to humidity or different climatic conditions and should go away with use. Since wood is a natural material, a gradual change in tone may occur over time. Furthermore, if the lamps have been purchased at different times, there will be differences in colour and tone, particularly in light coloured veneers. Luziferlamps S.L. will not be held responsible for this.

INSTALLATION TIP: Make sure that the seam on your lamp shade is facing away from the main view of the fixture.

PROTECTIVE FILMS: Don't forget to remove all protective films from the acrylic surfaces of your lamp.

MORE INFO: <http://www.lzf-lamps.com/guarantee/>



ASSEMBLY INSTRUCTIONS

1

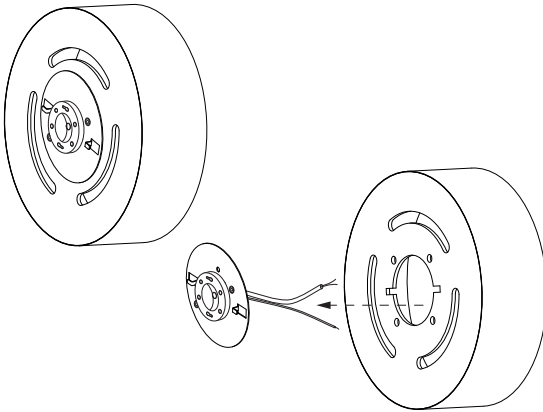

Remove the electrical back plate by detaching it from the shade.

2

MAINS CABLE

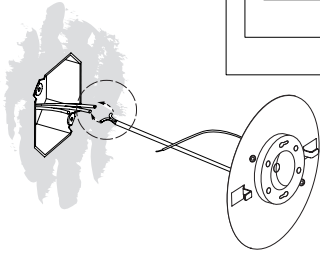
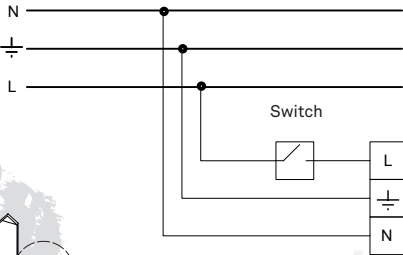

CONNECTION

Turn off the mains before installing the lamp.

Connect the lamp to the mains as follows.

You should have a three wire cable coming from the mains, **N**, **L** and **GND** (⊥).

Connect these to the cables of the same colour coming from the lamp.

3

Use allen key No. 2.5

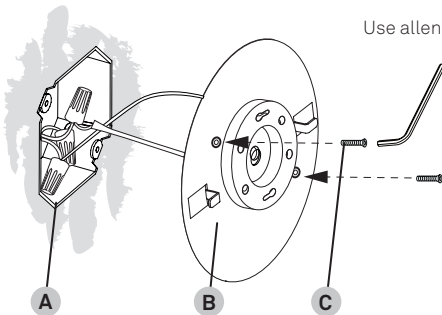

Fix the electrical back plate (B) to the junction box (A) with the screws (C).

ASSEMBLY INSTRUCTIONS

4

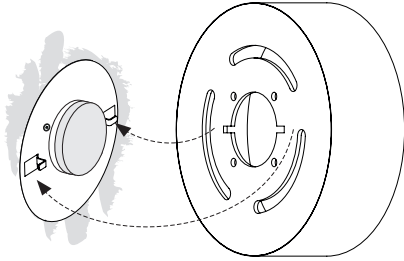

Install the bulb.

Return that shade to its position.

5

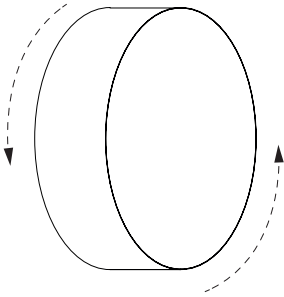

Turn it 90°.

6

Turn on the mains again.



GENERAL CARE INSTRUCTIONS

Use and care of your lamp.

You have just purchased an original handmade product by LZf. Your lamp is made out of FSC® certified natural wood veneer treated with our patented finish, Timberlite®.

This treatment both protects and safeguards the wood veneer against breakages.

Depending on the type of lamp use a feather duster, soft cleaning cloth or damp cloth for cleaning. On our more delicate shades, like those made from wood strips, a feather duster or an air blower is preferable. In our more solid shades a damp cloth may be used.

Clean only the flat surface of the veneer with the cloth, and please avoid any moisture contact along the edge of the veneer.

Acrylic Diffusers

The acrylic diffusers on your lamp can be cleaned with a regular window cleaning spray and a soft cloth. Do not use solvents of any kind.

Bulbs

Bulbs not included, unless indicated. We recommend using energy-saving light bulbs, like the CFL or LED bulbs. Please refer to the instruction manual or visit our website www.lzf-lamps.com to make sure you are using the best bulb for your type of lamp.

Precautions

Luminaire for indoor use only.

Avoid direct sunlight, strong indirect sunlight and moisture on your lamp. Unplug the lamp before cleaning or changing the light bulb. Servicing or manipulation of the electrical installation should only be performed by qualified electrical personnel or by the LZf service department.

REV.08-2018

D88_091



© Luzifertamps, S.L

All rights reserved.

Valencia, Spain. 2018

www.import-ent.com

support@import-ent.com