

ISTRUZIONI DI MONTAGGIO

INSTALLATION INSTRUCTION
INSTALLATIONSANLEITUNG
INSTRUCTIONS D'INSTALLATION
INSTRUCCIONES DE MONTAJE
تعليمات التركيب



HAT

DESIGN BY: PAOLA NAVONE



TA TAVOLO - TABLE

FL FLOOR - FLOOR

SOM SOSPENSIONE MEDIUM - SUSPENSION MEDIUM

SOL SOSPENSIONE LARGE - SUSPENSION LARGE

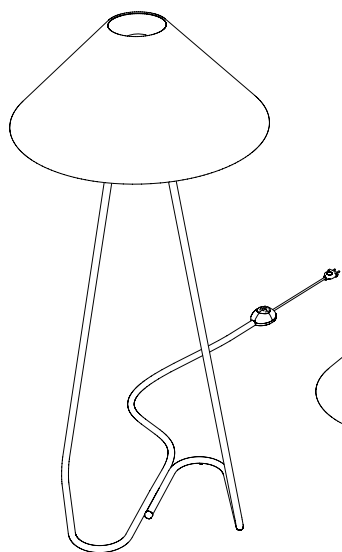

FL

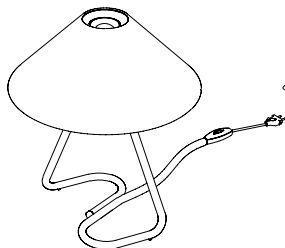

TA

SOM

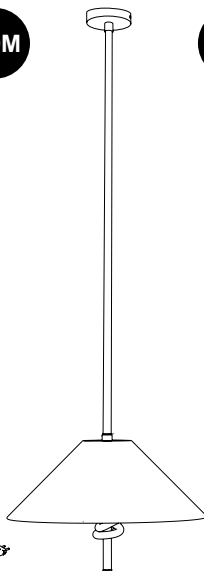

SOL

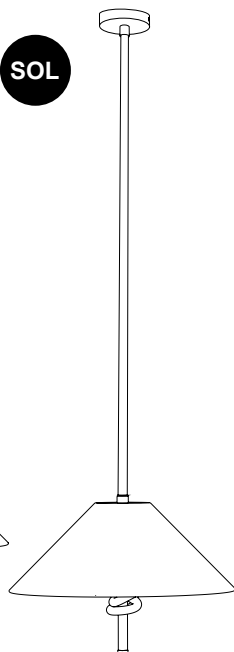

AVVERTENZE

CAUTIONS

WARNUNG

PRECAUTIONS

PRECAUCIONES

تنبيهات



1 Staccare la linea elettrica prima dell'installazione e di ogni intervento di manutenzione.

Utilizzare un interruttore bipolare

Switch-off the power supply before any installation and maintenance operations.

Use only a two-pole switch

Die Stromzufuhr muss vor der Installation / Wartung ausgeschaltet werden.

Nur mit einen zweipoligen Stecker zu verwenden

Couper la source d'alimentation avant toute installation et opération d'entretien.

Seulement utiliser avec un connecteur bipolaires

No efectuar la conexión de la lámpara con la tensión general activada.

Usar un interruptor bipolar

قم بفصل الخط الكهربائي قبل التركيب وأي عمل صيانة. استخدم مفتاح ذو قطبين.

2 L'installazione deve essere effettuata da personale qualificato secondo la normativa elettrica vigente.

Installation must be carried out only by qualified personnel according to safety norms and local regulations.

Die Installation muss nach den gültigen Sicherheitsvorschriften durch einen konzessionierten Elektroinstallateur erfolgen.

L'installation doit être réalisée par un électricien qualifié en respectant les prescriptions en vigueur.

La instalación debe ser realizada por una persona cualificada y de acuerdo a la normativa vigente.

يجب أن يتم التركيب بواسطة فنيين مؤهلين وفقاً للتشريعات الكهربائية السارية.

3. Utilizzare questo apparecchio a tensione e frequenza indicate nella tabella.

Use this light fixture at the rated voltage and frequency as indicated on the specification table.

Die Leuchte darf nur mit der angegebenen Spannung und Frequenz betrieben werden.

Respecter les prescriptions de tension et de fréquence indiquées dans le tableau final.

Utilice esta lámpara a la tensión y frecuencia indicadas en las instrucciones.

استخدم هذا الجهاز عند الجهد الكهربائي والتردد المحددين في الجدول.

4. Queste istruzioni di montaggio devono essere conservate dal responsabile dell'installazione e manutenzione dell'apparecchio.

This installation manual must be retained by the person responsible for the installation and maintenance of the product.

Bewahren Sie diese Gebrauchsanweisung für den verantwortlichen Benutzer / Wartungstechniker auf.

Gardez cette instruction pour l'utilisateur / technicien de maintenance.

Estas instrucciones deben ser conservadas por el responsab

يجب الاحتفاظ بهذه التعليمات بواسطة المسؤول عن تركيب وصيانة الجهاز.

DIMENSIONI

DIMENSIONS

ABMESSUNGEN

DIMENSIONS

DIMENSIONES

الأبعاد

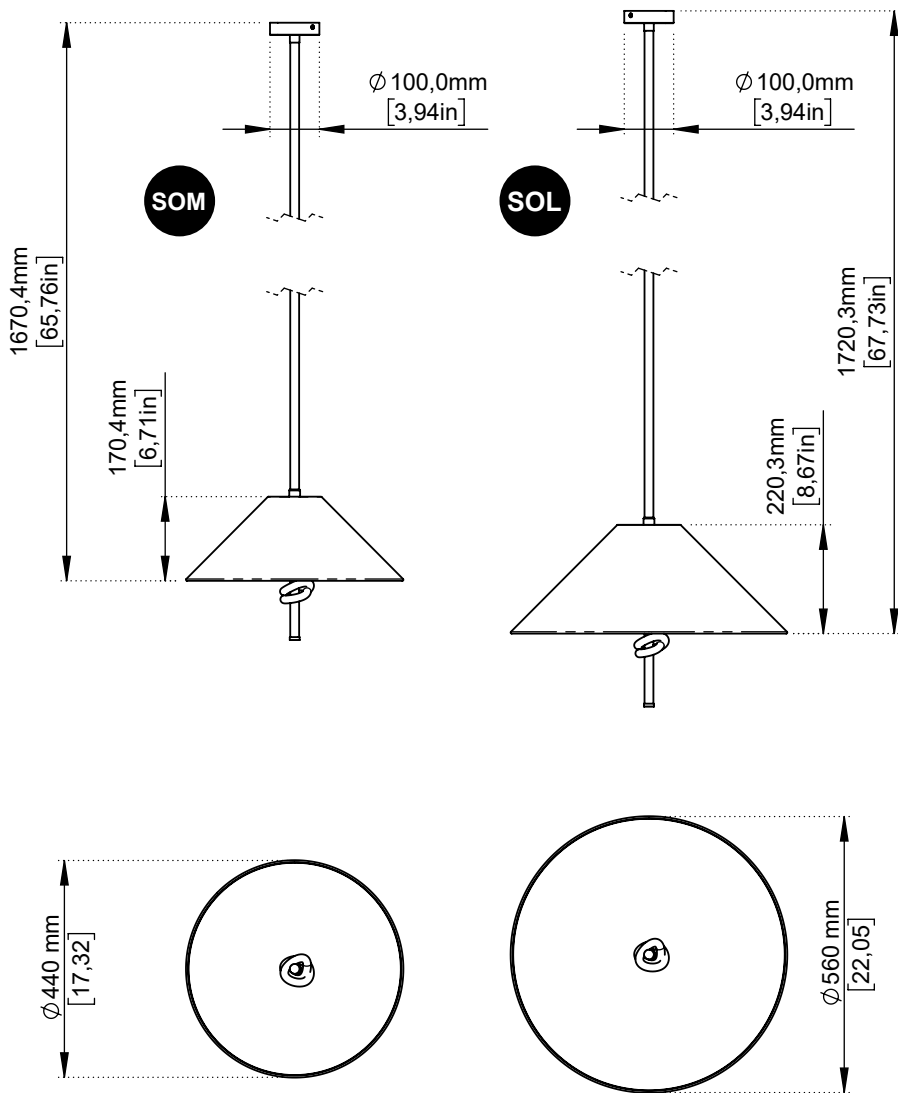

DIMENSIONI

DIMENSIONS
ABMESSUNGEN
DIMENSIONS
DIMENSIONES
الأبعاد

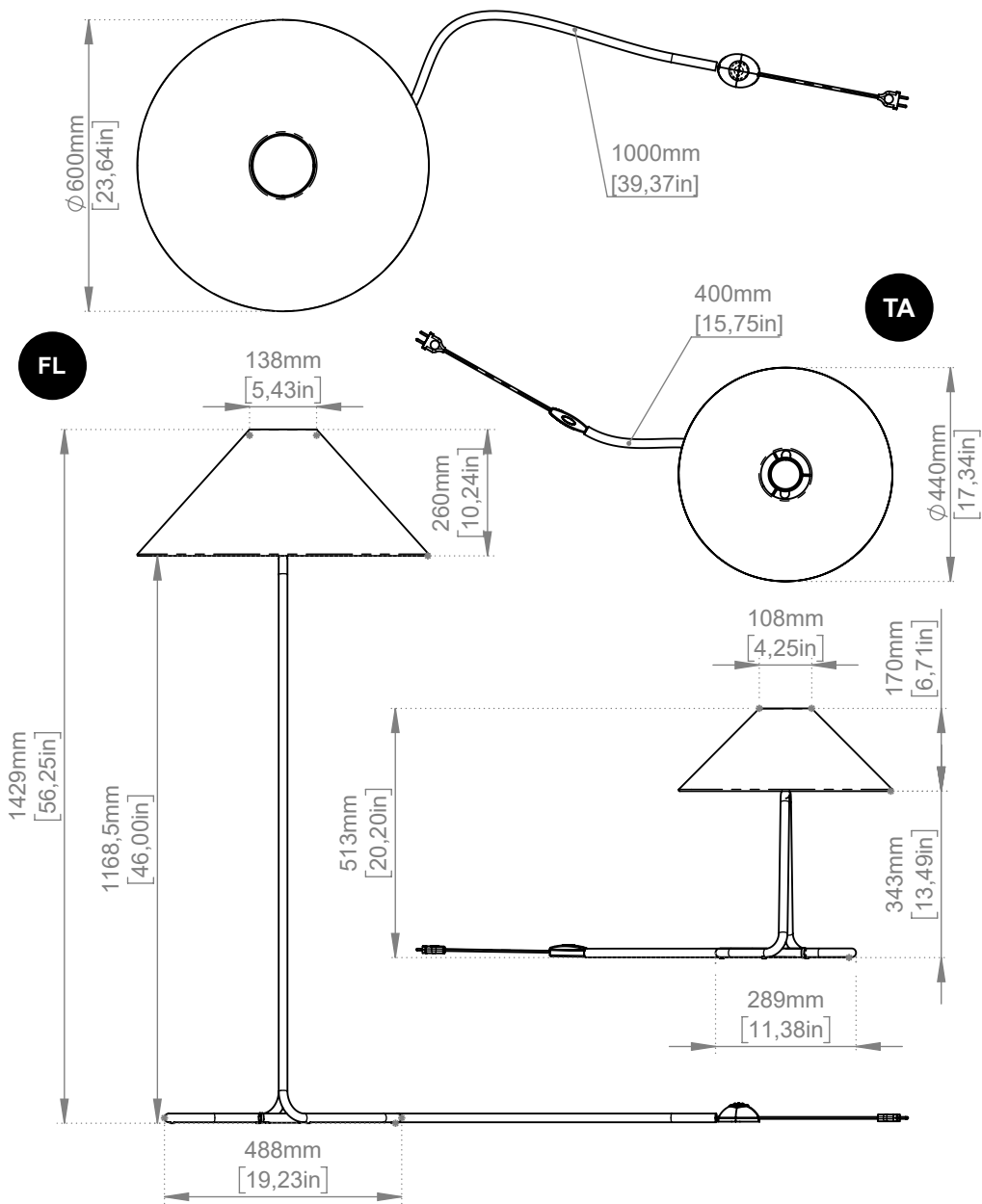

CARATTERISTICHE

SPECIFICATION

BESCHREIBUNG

CARACTERISTIQUES

ESPECIFICACIONES

المواصفات

DIMENSIONI | DIMENSIONS

| MOD. | L (mm) | H (mm) | D (mm) | W (kg) |
|-----------|--------|--------|--------|--------|
| TA | 440 | 440 | 513 | 1,5 |
| FL | 600 | 600 | 1429 | 3,5 |
| SO MEDIUM | 440 | 440 | 1670 | 1,5 |
| SO LARGE | 600 | 600 | 1720 | 2 |

SPECIFICHE ILLUMINOTECNICHE FRONTE | LIGHTING SPECIFICATIONS FRONT

| MOD. | V | f (Hz) | W | Lm | °K | CRI |
|-----------|-----|--------|----|------|------|-----|
| TA | 220 | 50-60 | 11 | 1521 | 2700 | >90 |
| FL | 220 | 50-60 | 11 | 1521 | 2700 | >90 |
| SO MEDIUM | 220 | 50-60 | 12 | 1440 | 3000 | >90 |
| SO LARGE | 220 | 50-60 | 14 | 1680 | 3000 | >90 |

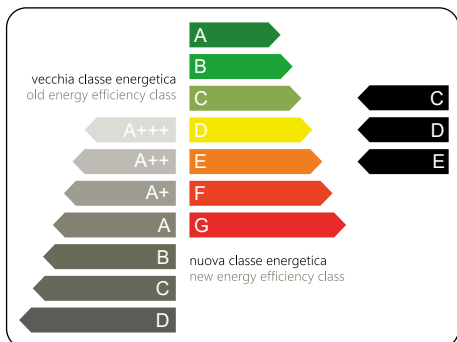

IP20



DOTAZIONE

EQUIPMENT

ÉQUIPEMENT

AUSRÜSTUNG

EQUIPO

المعدات

Il prodotto deve essere installato e messo a punto da personale esperto e specializzato. Contardi declina ogni responsabilità derivante dall'inosservanza di tale disposizione. La responsabilità del collaudo è a carico dell'installatore.

The product must be installed and set up by trained and experienced personnel. Contardi disclaims any liability arising from failure to do so. Responsibility for testing is the responsibility of the installer.

Le produit doit être installé et mis en place par du personnel expérimenté et spécialisé. Contardi décline toute responsabilité en cas de manquement à cette règle. La responsabilité des tests incombe à l'installateur.

Das Produkt muss von erfahrener und spezialisiertem Personal installiert und aufgestellt werden. Contardi übernimmt keine Haftung, wenn dies nicht der Fall ist. Die Verantwortung für die Prüfung liegt beim Installateur.

El producto debe ser instalado y montado por personal experimentado y especializado. Contardi declina toda responsabilidad en caso contrario. La responsabilidad de las pruebas recae en el instalador.

يجب تركيب المنتج وإعداده بواسطة موظفين متخصصين وذوي خبرة.

لا تتحمل كونتاردي أي مسؤولية عن عدم القيام بذلك. تقع مسؤولية الاختبار على عاتق القائم بالتركيب.

SOM

SOL

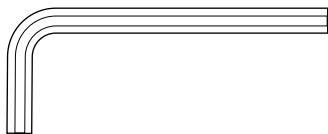

1X

CHIAVE A BRUGOLA 2.5 mm
ALLEN KEY 2.5 mm

4X

TASSELLI MURO Ø 6 L. 30 mm
WALL PLUG Ø 6 L. 30 mm

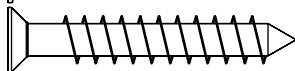
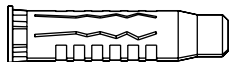

NO cartongesso
NO plasterboard

1X

NASTRO AGGLOMERANTE
BONDING TAPE



INSTALLAZIONE

INSTALLATION

MONTAGE

INSTALLATION

INSTALACIÓN

التثبيت

SOM

SOL

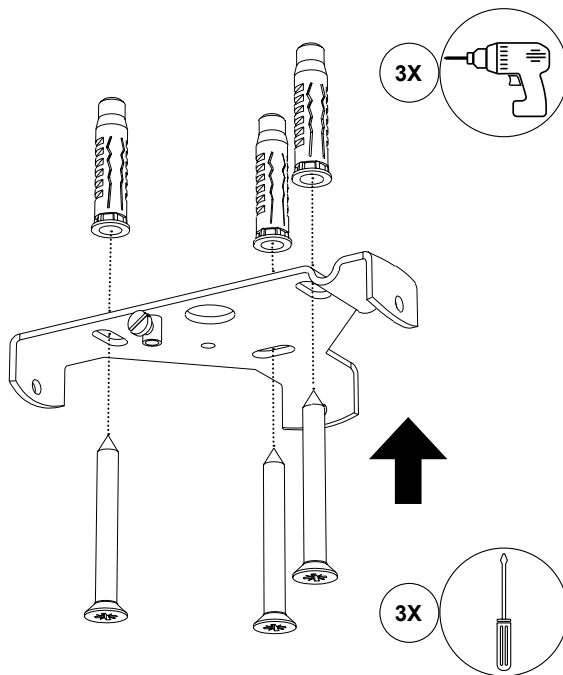
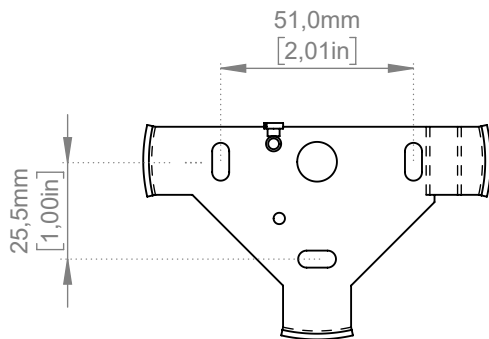

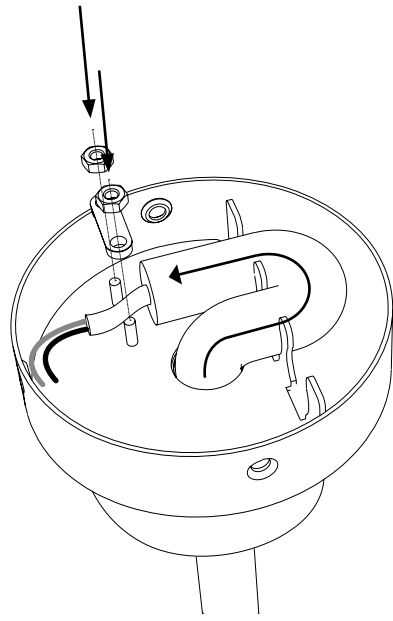
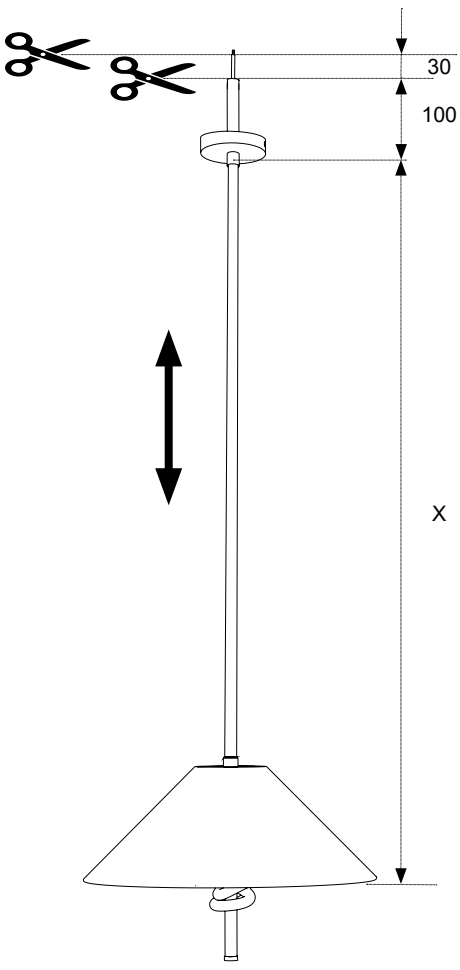

CONNESSIONE

CONNECTION
VERBINDUNG
CONNEXION
CONEXIÓN
الاتصال



STACCARE LA CORRENTE
SWITCH OFF
AUSSCHALTEN
INTERRUPTEUR OFF
INTERRUPTOR APAGADO
إيقاف التشغيل

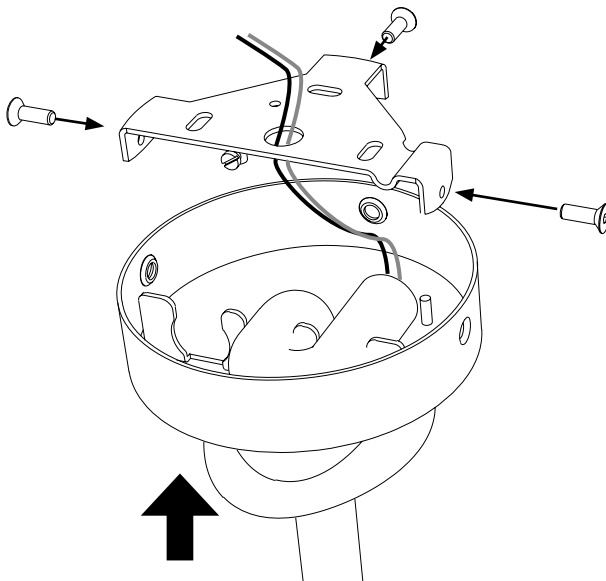
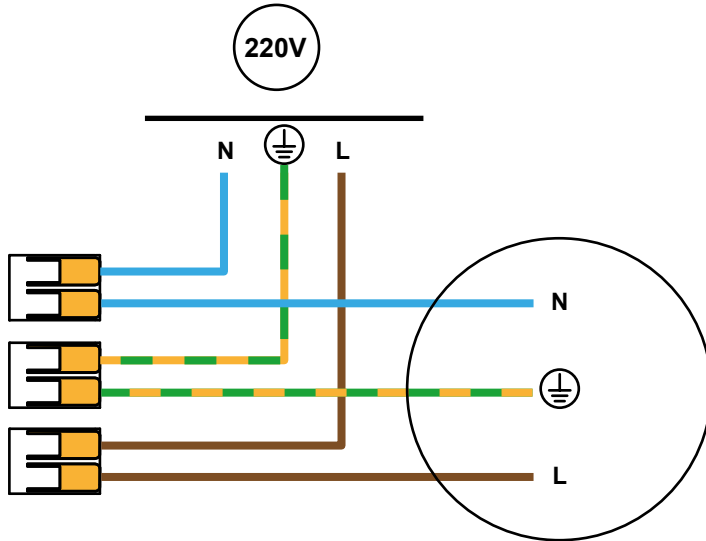

INSTALLAZIONE

INSTALLATION

MONTAGE

INSTALLATION

INSTALACIÓN

التثبيت

TA

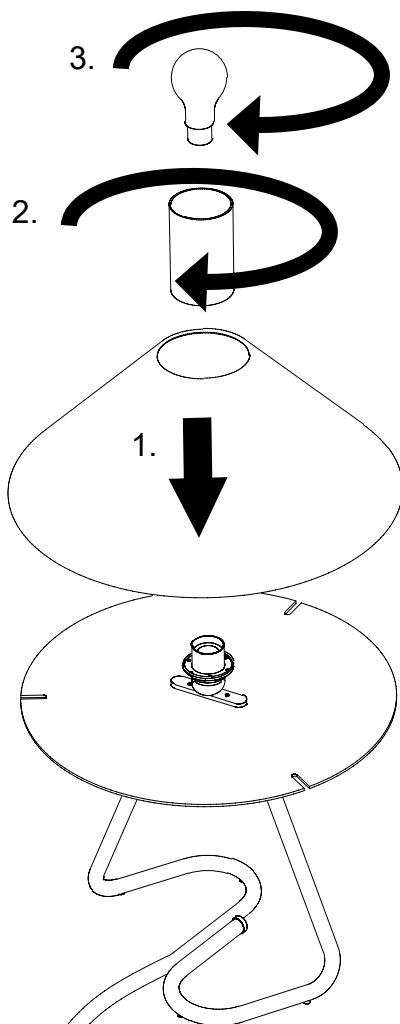
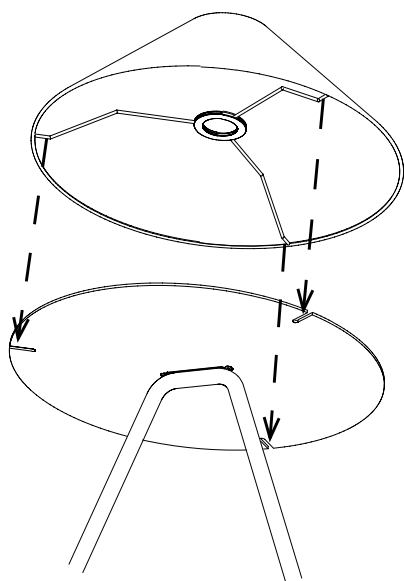

INSTALLAZIONE

INSTALLATION

MONTAGE

INSTALLATION

INSTALACIÓN

التثبيت

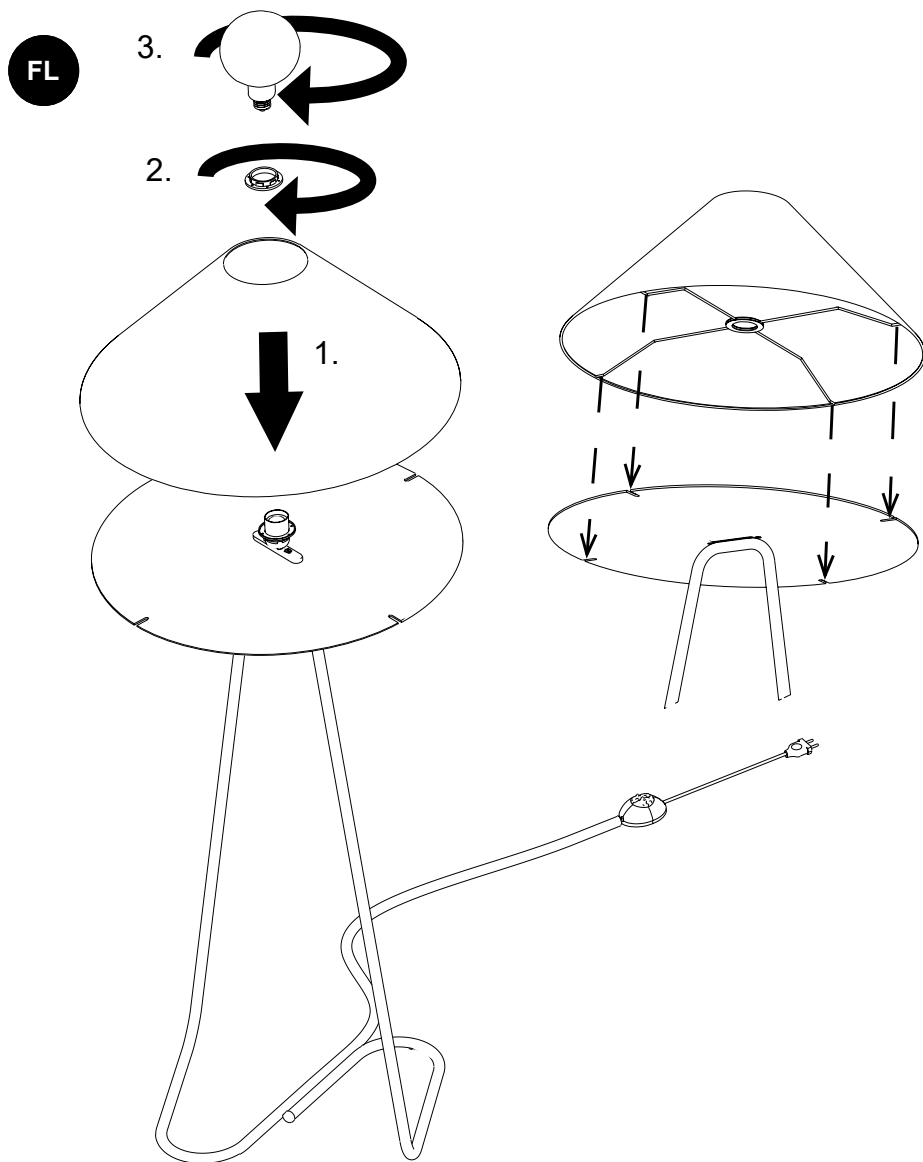

INSTALLAZIONE

INSTALLATION

MONTAGE

INSTALLATION

INSTALACIÓN

التثبيت

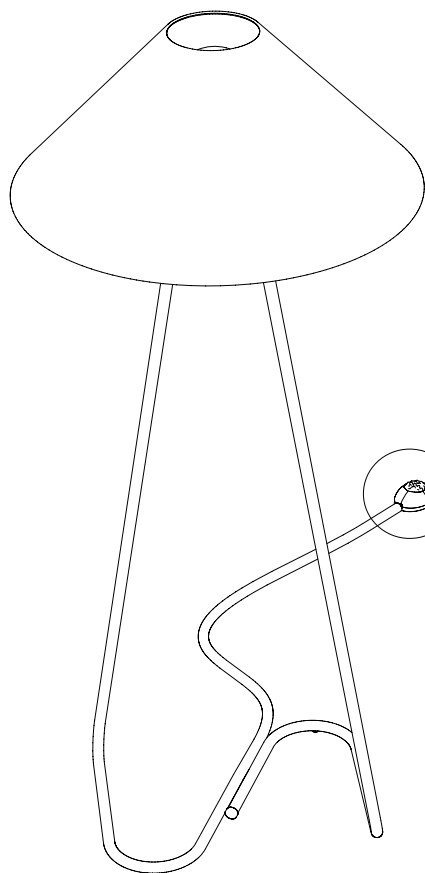

FL

ON/OFF/DIMMER

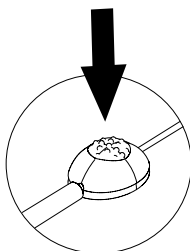

ON/OFF/DIMMER

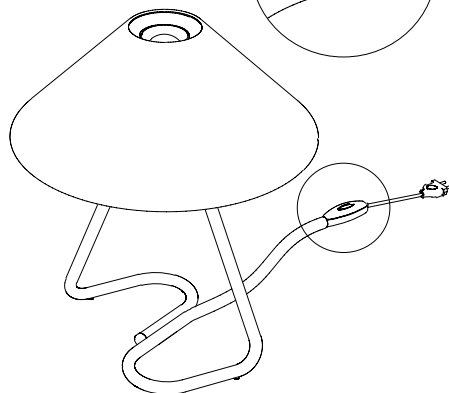
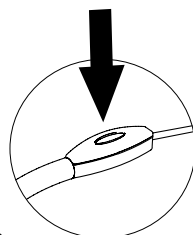

TA

DOCUMENTAZIONE AGGIUNTIVA

ADDITIONAL DOCUMENTATION

ZUSÄTZLICHE DOKUMENTATION

DOCUMENTATION SUPPLÉMENTAIRE

DOCUMENTACIÓN ADICIONAL

وثائق إضافية



COLLEZIONE

COLLECTION

KOLLEKTION

COLLECTION

COLECCIÓN

مجموعة

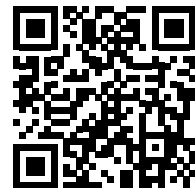

SITO WEB CONTARDI

CONTARDI WEBSITE

CONTARDI-WEBSITE

SITE WEB CONTARDI

SITIO WEB CONTARDI

موقع ويب كونتاردي



Contardi Lighting Srl

Headquarters

Via A. Manzoni, 134/140

20811 Cesano Maderno – MB Italy