

SAFETY INFORMATION

Please read and understand this entire manual before attempting to assemble, install or operate the product.

WARNING

- RISK OF ELECTRIC SHOCK - Before beginning installation, turn off electricity at the circuit breaker box or the main fuse box.
- RISK OF FIRE - Use bulbs specified by the markings and/or labels on the fixture.
- Use ONLY LED bulbs in this fixture. Incandescent and halogen lamps may cause severe thermal damage.

CAUTION

- For your safety, read instructions completely before beginning installation.
- If in doubt about electrical installation, consult a licensed electrician.
- Turn off electricity to fixture before replacing the bulb(s).

TOOLS REQUIRED

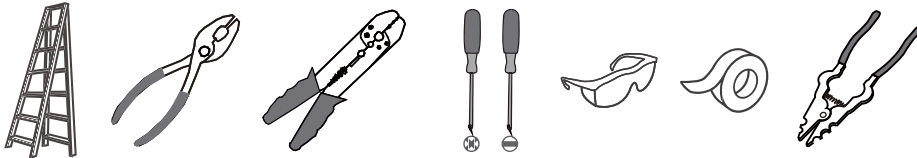

CARE AND MAINTENANCE

- Wipe clean using soft, dry cloth or static duster. Always avoid using harsh chemicals and abrasives to clean fixture as they may damage the finish.

If you need further assistance call Quoizel Customer Care at 1-800-645-3184 (9:00am - 5:00pm EST), or visit us on-line at www.quoizel.com.

PACKAGE CONTENTS

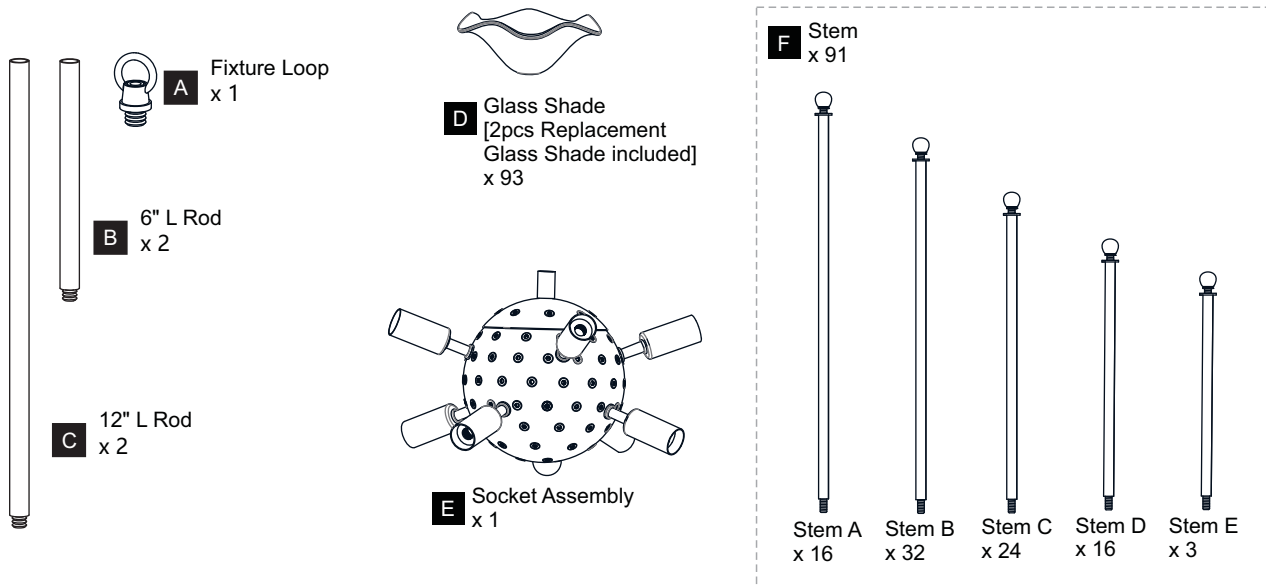

MOUNTING HARDWARE

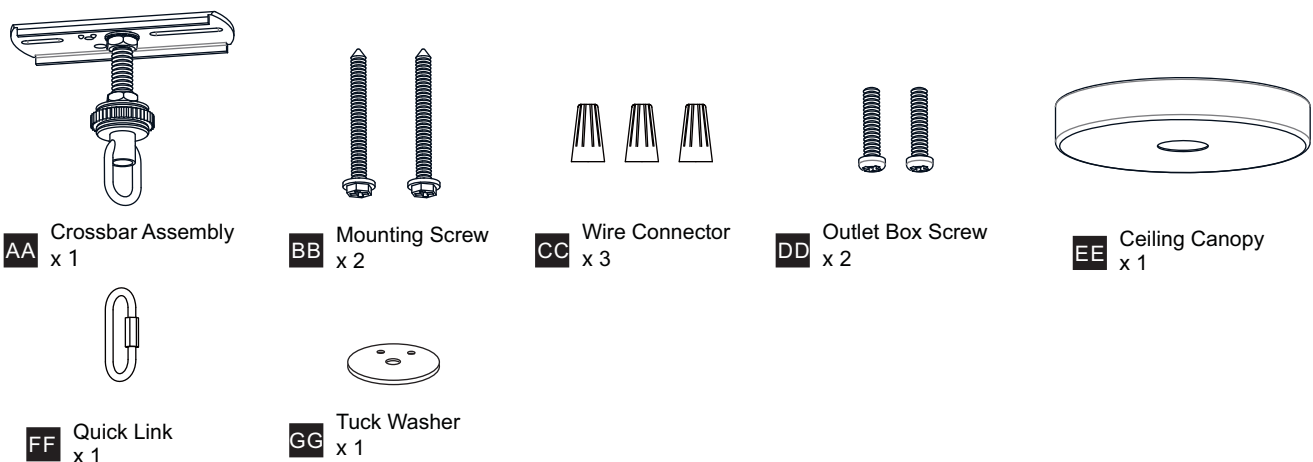

1 Install Stems

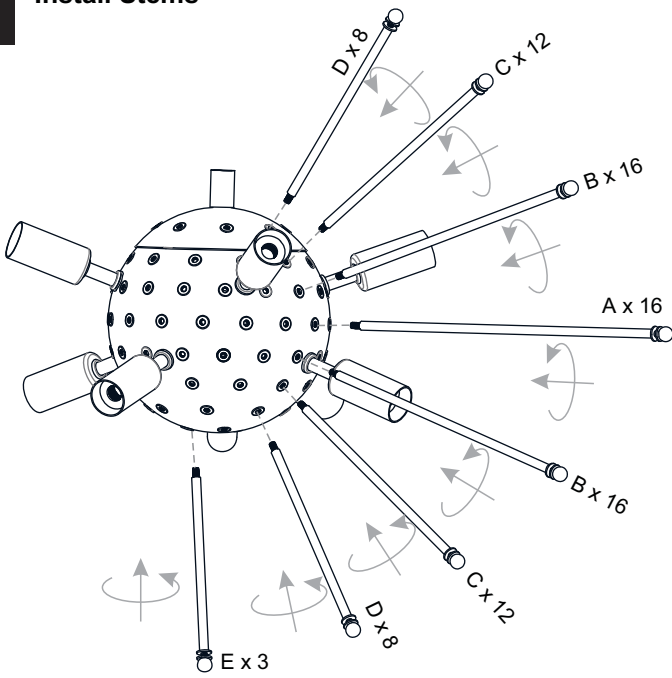

2 Install Rods

Optional Rods:

8 Feet Ceiling:
(2) 12"L Rods.
9 Feet Ceiling:
(2) 6"L Rods + (2) 12"L Rods.

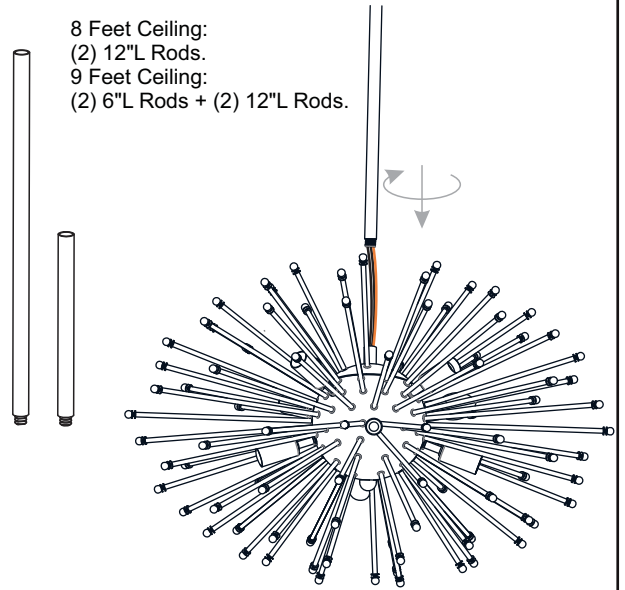

3 Install Fixture Loop

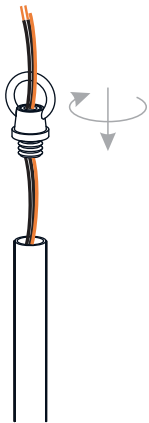

4 Install Crossbar Assembly

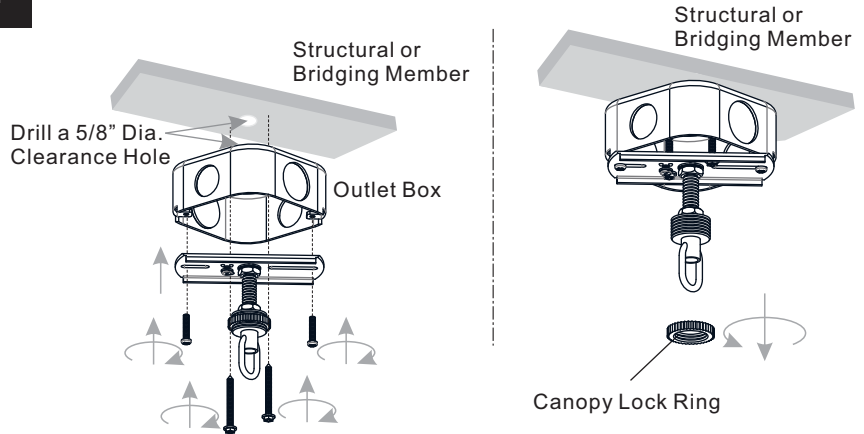

5 Install Quick Link

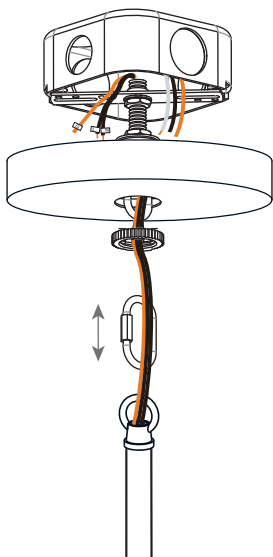

* Ceiling Canopy shape is varies depends on item purchased.

6 Pull Supply Wires and Safety Cable

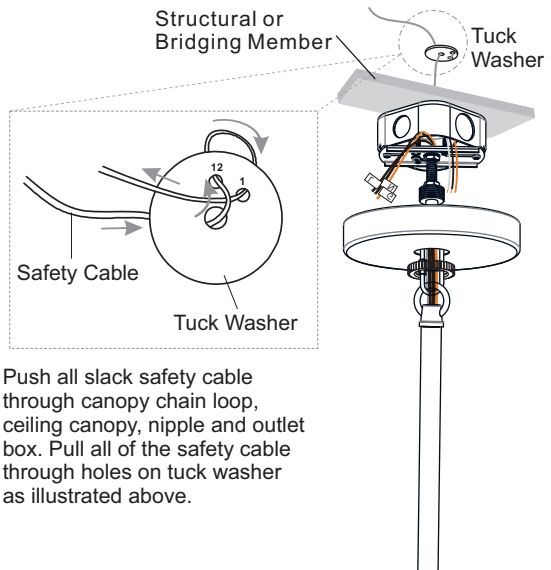

Push all slack safety cable through canopy chain loop, ceiling canopy, nipple and outlet box. Pull all of the safety cable through holes on tuck washer as illustrated above.

INSTALLATION

7 Wiring

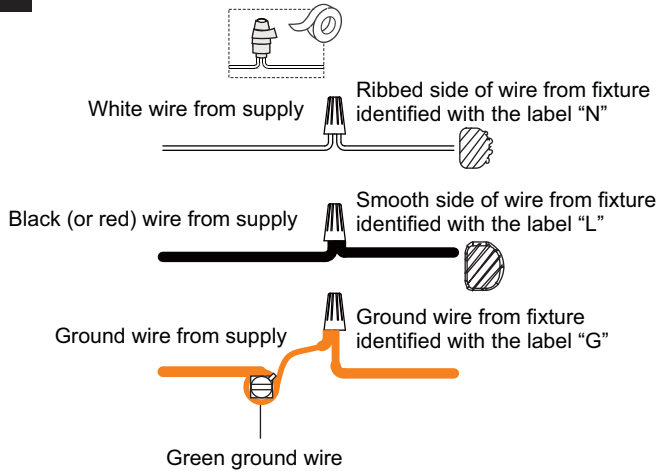

8 Install Ceiling Canopy

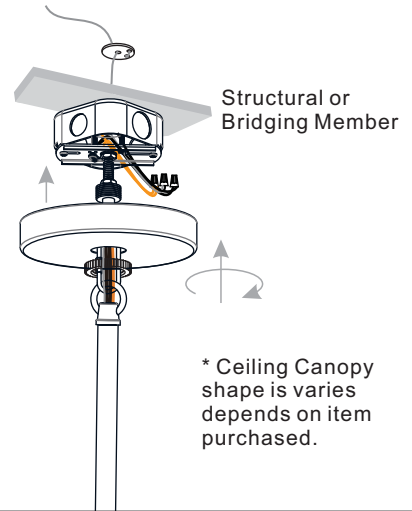

9 Install Bulbs

Install eight correct bulbs referring to fixture markings and/or labels for maximum wattage.

Recommended Bulb Type (not included):

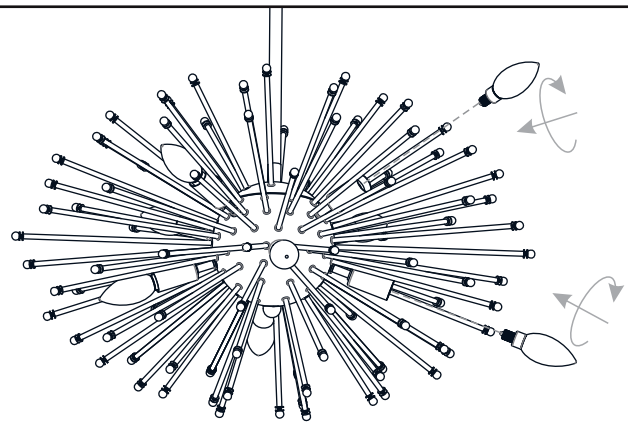
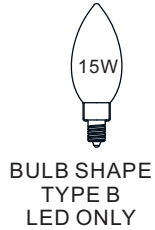

10 Install Glass Shades

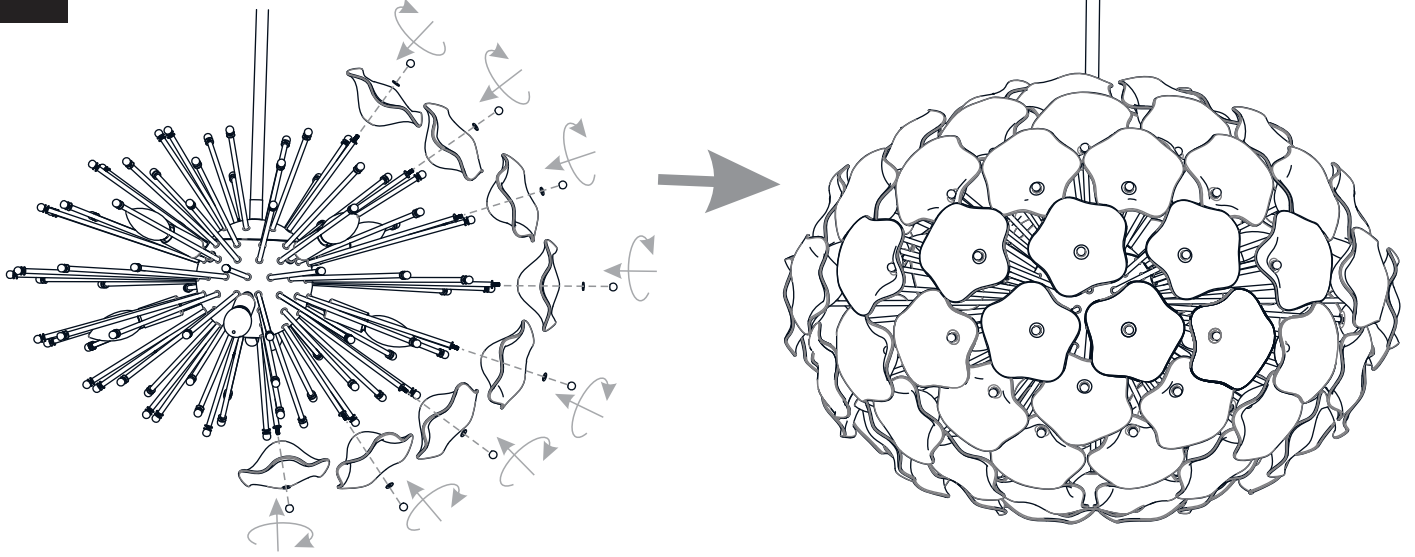

Your installation is now complete! Restore electricity and save this sheet for future reference.