

Installation Instructions

NHRMIC2

Marquise II IC Air-Tight Remodel Housing

READ PRIOR TO ATTEMPTING INSTALLATION
ALWAYS TURN OFF MAIN POWER BEFORE INSTALLATION
INSTALLATION SHOULD BE CARRIED OUT BY YOUR LOCAL ELECTRICIAN

Fixtures are listed for insulated ceilings—Type IC, airtight—AT. To insure safe and reliable operations, make sure the fixture corresponds to the proper ceiling installation. Read the following material carefully before beginning installation. In general these instructions apply to “round” housings. Drawings of “round” housings have been used to illustrate installation procedures. Before attempting installation of any recessed lighting fixture check your local electrical code. This code sets the wiring standards for your locality and should be carefully studied before starting work.

INSULATED CEILINGS - TYPE IC

Insulated Ceiling
The insulated ceiling or IC approved recessed fixture is one that can be installed in direct contact with insulation.

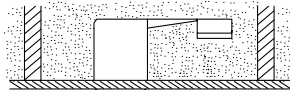

AIRTIGHT INSTALLATION

Nora housings certified under ASTM E283 are supplied with a pre-installed gasket or supplied with a ready-to-install self adhesive gasket.

- Step 1. Lay gasket flat and peel protective paper backing from gasket to expose adhesive side.
- Step 2. Apply supplied gasket to ceiling lip and wrap gasket around inside of housing to form seal of the ceiling opening or apply caulk per state/local code. When properly installed, Nora housings provide compliance with restricted air-flow regulations.

FIRE/ELECTRICAL HAZARD: INSTALL ACCORDING TO NATIONAL ELECTRIC CODE AND ANY APPLICABLE MUNICIPAL CODE REQUIREMENTS.

This equipment is intended to be installed only by qualified personnel. The installation must be made in accordance with the current edition to the National Electric Code and all applicable state and local building codes. The final installation must be approved by the appropriate qualified electrical/building inspector(s). Improper installation may result in a fire or electrical hazard. Be sure the electrical power to the circuit has been disconnected before installing this electrical system.

For additional details, contact technical support at 800.686.6672.

FEU / RISQUE ÉLECTRIQUE: INSTALLER SELON AU CODE ÉLECTRIQUE NATIONAL ET LES EXIGENCES DE CODE MUNICIPAUX APPLICABLES.

Cet équipement est destiné à être installé par un personnel qualifié. L'installation doit être faite conformément à l'édition actuelle du Code national de l'électricité et tous les codes d'état et de construction locaux applicables. L'installation finale doit être approuvée par l'inspecteur en électricité / bâtiment qualifié approprié (s). Une mauvaise installation peut provoquer un incendie ou un risque électrique. Assurez-vous que l'alimentation électrique du circuit a été coupée avant l'installation de ce système électrique. Pour plus de détails, contactez le support technique au 800.686.6672.

IMPORTANT- RISK OF FIRE:

Most dwellings built before 1985 have supply wire rated 60°C (thermal cutoffs in fixtures operate at 90°C); consult a qualified electrician prior to installation. If supply wires are located within three inches of fixture, use wire rated for at least 90°C. Contact technical support at 1-800-686-6672 for additional details.

IMPORTANT-RISQUE D'INCENDIE:

La plupart des logements construits avant 1985 ont le fil d'alimentation nominale de 60°C (disjoncteurs thermiques dans les appareils fonctionnent à 90°C); consultez un électricien qualifié avant l'installation. Si les fils d'alimentation sont situés à moins de trois pouces de l'appareil, l'utilisation de fil résister au moins à 90°C. Contactez le support technique au 1-800-686-6672 pour plus de détails.

CUTTING A HOLE

1. Locate the center of proposed opening on your tile or ceiling and mark it.
2. Use a compass to draw a circle in diameter around the center point. See chart for cut-out dimension.
3. Cut along this circular line.

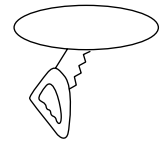

Cut-out dimension	
NHRMIC2-485	4-1/4"
NHRMIC2-585	5-5/8"
NHRMIC2-685	6-3/8"

HOUSING INSTALLATION

1. Push ceiling spring clips into housing to insert into ceiling opening. (Figure 1)
2. Insert housing until housing lip is flush with ceiling.
3. Push ceiling spring clips out of fixture until clip is flush with interior of housing. (Figure 2)
4. Using a screwdriver, force the small tab at the top of the clip up and as tightly as possible against the housing wall to lock fixture into place.

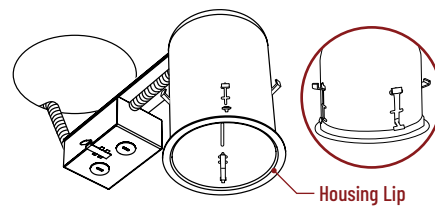

Figure 1

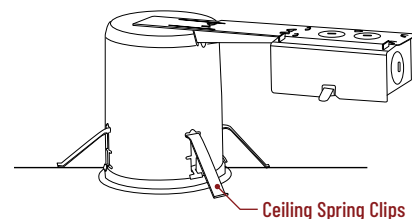

Figure 2

WIRING DIAGRAM:

Refer to wiring diagram on page 2.

NOTE ON GROUNDING: Many structures carry grounding via steel conduit. If this is the case, if there is no grounding wire, simply leave green wire on fixture unattached. Fixture will be grounded through attachment of conduit to junction box. However, if Romex or PVC conduit is used, ground wire will always be present, and must be connected to green wire on fixture junction box to avoid electrical shock hazard.

Installation Instructions

NHRMIC2

Marquise II IC Air-Tight Remodel Housing

READ PRIOR TO ATTEMPTING INSTALLATION
ALWAYS TURN OFF MAIN POWER BEFORE INSTALLATION
INSTALLATION SHOULD BE CARRIED OUT BY YOUR LOCAL ELECTRICIAN

ELECTRICAL CONNECTIONS:

1. Connect ½ inch trade size steel conduit to junction box with appropriate fitting. If using Romex-type shielded wiring, use rectangular pry-out strain reliefs located on upper corners of junction box.
2. Connect wires accordingly:
 - Black (120/277V) = Supply Voltage
 - White = Neutral
 - Green or Copper Wire = Grounding Junction Box Wire**0-10V Wiring:**
 - Purple = Dim (+)
 - Pink or Grey = Dim (-)(Maximum of 8 no. 12 AWG through branch circuit conductors suitable for at least 90°C permitted in junction box. AC ONLY)

NOTE ON GROUNDING: Many structures carry grounding via steel conduit. If this is the case, if there is no grounding wire, simply leave green wire on fixture unattached. Fixture will be grounded through attachment of conduit to junction box. However, if Romex or PVC conduit is used, ground wire will always be present, and must be connected to green wire on fixture junction box to avoid electrical shock hazard.

120/277V CONNECTION:

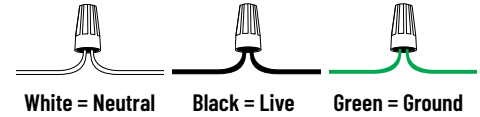

0-10V DIMMING CONNECTION:

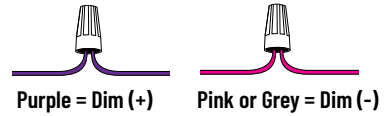

* cap off 0-10V wires if dimming wires are not used *

WIRING DIAGRAM (0-10V DIMMING)

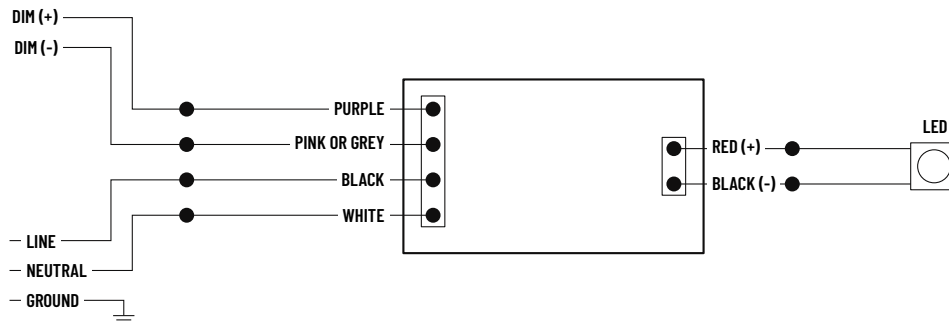

Installation Instructions

NHRMIC2

Marquise II IC Air-Tight Remodel Housing

READ PRIOR TO ATTEMPTING INSTALLATION
 ALWAYS TURN OFF MAIN POWER BEFORE INSTALLATION
 INSTALLATION SHOULD BE CARRIED OUT BY YOUR LOCAL ELECTRICIAN

REMOTE EMERGENCY CONNECTION (NEPK-07LEDUNV)

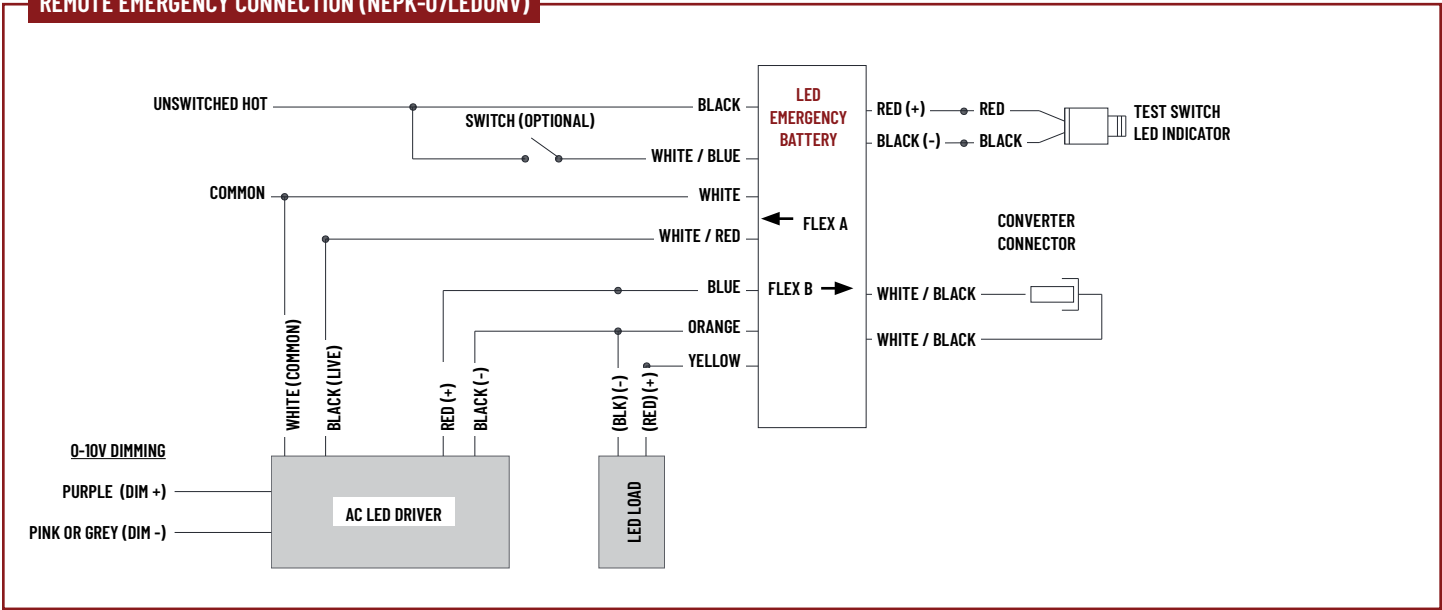

REMOTE EMERGENCY CONNECTION (PHILIPS BODINE BSL17C-C2)

