

**SAFETY INFORMATION**

Please read and understand this entire manual before attempting to assemble, install or operate the product.

**WARNING**

- RISK OF ELECTRIC SHOCK - Before beginning installation, turn off electricity at the circuit breaker box or the main fuse box.
- RISK OF FIRE - Use bulbs specified by the markings and/or labels on the fixture.
- Use ONLY LED bulbs in this fixture. Incandescent and halogen lamps may cause severe thermal damage.

**CAUTION**

- For your safety, read instructions completely before beginning installation.
- If in doubt about electrical installation, consult a licensed electrician.
- Turn off electricity to fixture before replacing the bulb(s).

**TOOLS REQUIRED**

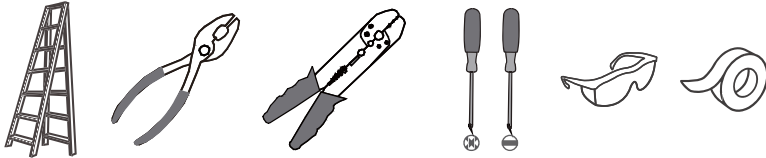

**CARE AND MAINTENANCE**

- Wipe clean using soft, dry cloth or static duster. Always avoid using harsh chemicals and abrasives to clean fixture as they may damage the finish.

If you need further assistance call Quozel Customer Care at 1-800-645-3184 (9:00am - 5:00pm EST), or visit us on-line at [www.quozel.com](http://www.quozel.com).

**PACKAGE CONTENTS**

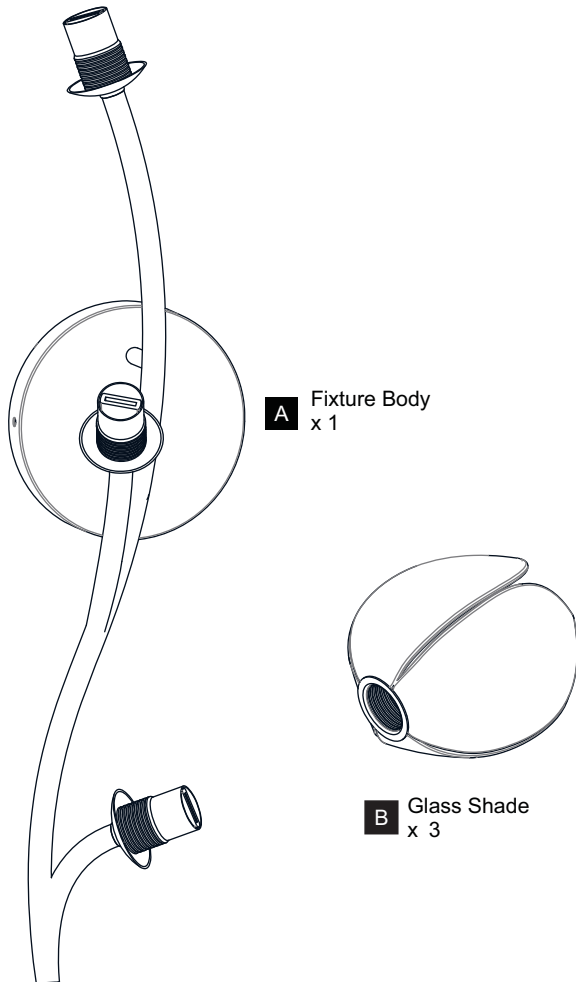

**MOUNTING HARDWARE**



**AA** Crossbar  
x 1



**BB** Mounting Screw  
x 2

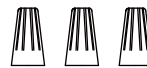

**CC** Wire Connector  
x 3



**DD** Outlet Box Screw  
x 2

# INSTALLATION

## 1 Install Crossbar

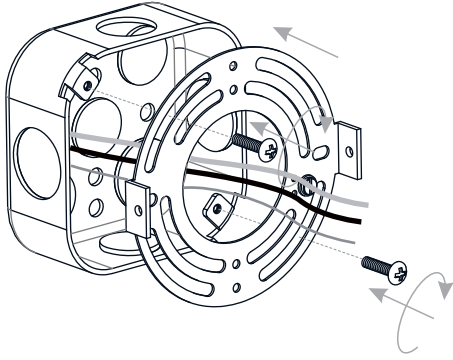

## 2 Wiring

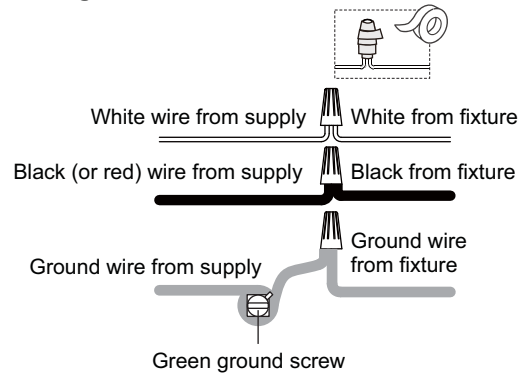

## 3 Install Fixture Body

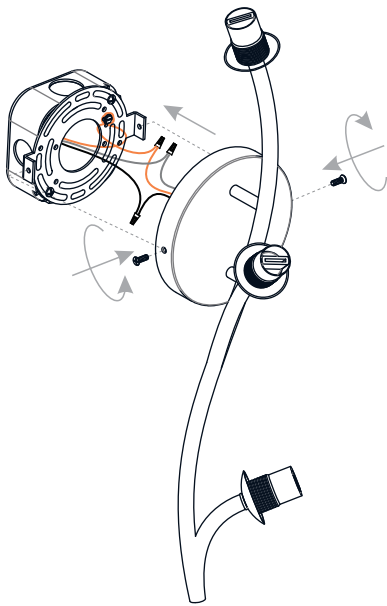

## 4 Install Glass Shades

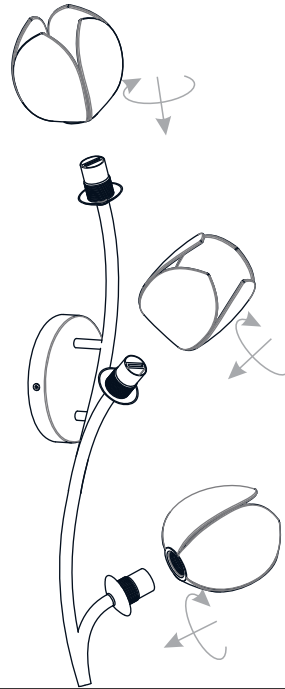

## 5 Install Bulbs

Install three correct bulbs referring to fixture markings and/or labels for maximum wattage.

**Recommended Bulb Type (not included):**



BULB BASE TYPE  
G9 BASE

10W MAX

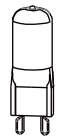

BULB TYPE  
TYPE G9 LED ONLY

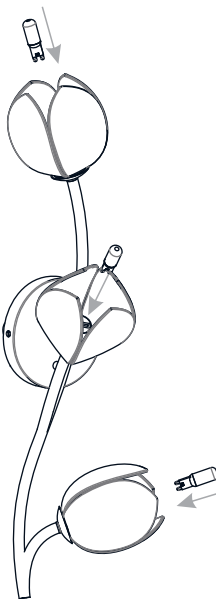

\* Do not touch the bulb with bare hands use a cloth or glove.

**Your installation is now complete! Restore electricity and save this sheet for future reference.**