

MIDWAY

RECESSED COLLECTION



3.5" 45368 ROUND FIXED DOWNLIGHT



The Midway collection is a family of integrated led recessed lights available in sizes ranging from 2"-6". With their durable die cast aluminum bodies and built on CCT color selecting switch Midway family fixtures are aesthetically appealing, functional and extremely versatile. Their IC rated shallow bodies allow them to be used in most residential and commercial installations with or without insulation in the ceiling. Midway fixtures are available in white or black finish and come standard with a reliable phase dimming power supply.

PROJECT: _____

TYPE: _____

DATE: _____

NOTES: _____

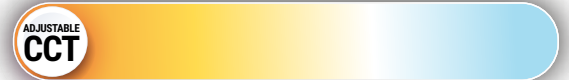

2700K . 3000K . 3500K . 4000K . 5000K

SPECIFICATIONS

LIGHT HOUSING

- IC Airtight Cast aluminum body.
- Remodel application. C/W spring loaded clips.
- Mates to driver box with quick connector.
- Max Ceiling thickness 5/8".
- Approved for damp location.

DIMENSIONS

- Cut hole: $\varnothing 3 \frac{3}{4}$ ".
- Fixture: $\varnothing 4 \frac{3}{8}$ " x $3 \frac{1}{4}$ "H.

ELECTRICAL

- 120 V Input class 2 constant current dimmable driver enclosed in junction box.
- TRIAC and ELV dimming.
- Min operating temperature (-4°F~-104°F)(-20°C~-40°C).

LIGHT MODULE

- 1 x 12W Integrated LED COB.
- Lumen maintenance 70% 50,000 hrs.
- CRI: 90+
- Beam angle: 38 degree.
- Kelvin (CCT): 27K | 30K | 35K | 40K | 50K
- Delivered Lumen: 702 lm | 750 lm | 818 lm | 859 lm | 854 lm

CERTIFICATIONS



ORDERING GUIDE

MODEL	FINISH
45368-028	Black
45368-011	White

ACCESSORIES



	WATTS	LUMENS	KELVIN	DIMMABLE	CRI	BEAM ANGLE	ADJUSTABLE
 $\varnothing 3 \frac{3}{4}$ "	12W	Up to 859	CCT Selectable	TRIAC/ELV	90+	38°	NO



PRODUCT DIMENSIONS

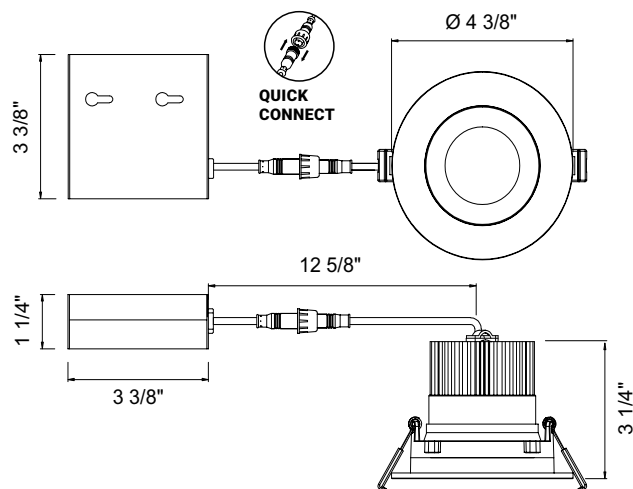



MIDWAY
RECESSED COLLECTION



Imperial

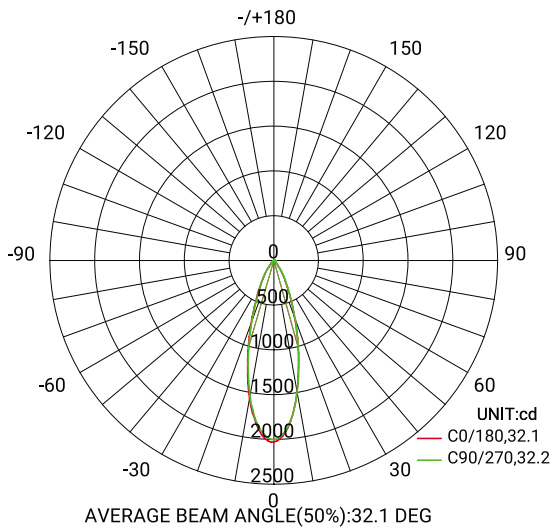

Flux out: 351.3 lm

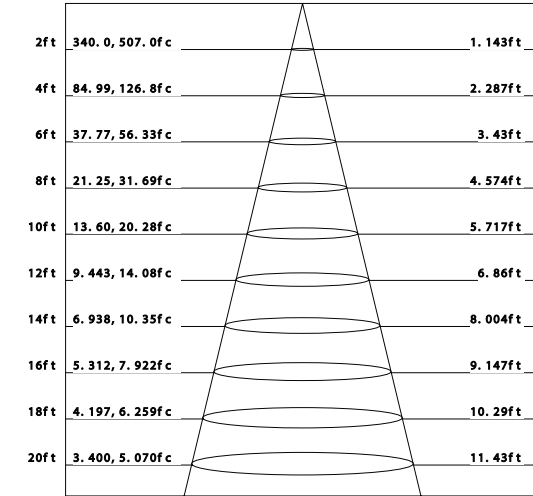

Height Eavg, Emx Angle: 31.91deg Diameter
 Note: The Curves indicate the illuminated area and the average illumination when the luminaire is at different distance.

Metrics

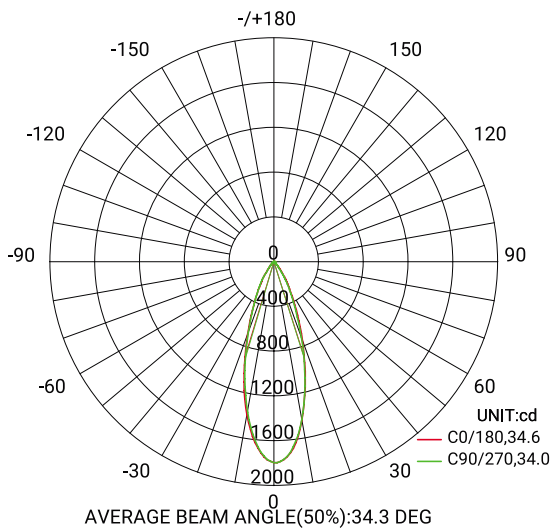

Flux out: 384.7 lm

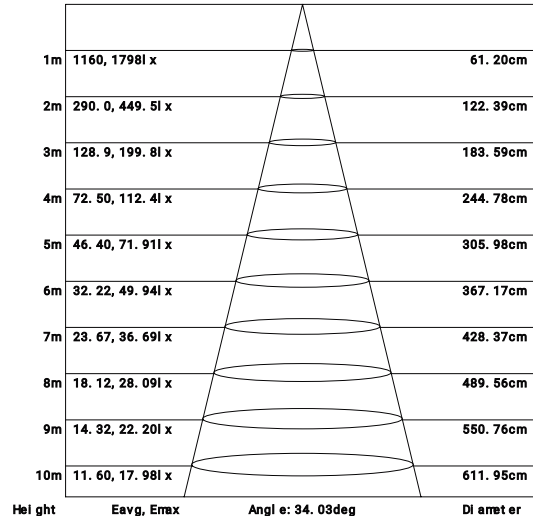

Height Eavg, Emx Angle: 34.03deg Diameter
 Note: The Curves indicate the illuminated area and the average illumination when the luminaire is at different distance.